



# Executive Casegoods/Tables



# Table of Contents

## Quick Reference

### Casegoods

Sherbrooke™	7-20
Orlando™ by SMED™	21-42
Tripoli™ by SMED	43-82
PLACES®	83-110
Varia® by SMED	111-152
Nottingham™	153-166

### Conference Tables

Entropy™ by SMED	167-170
Series K™/Profile/Tripoli by SMED	171-184
Varia by SMED	185-195
Nottingham	196

### Occasional Tables

Tripoli by SMED	197-199
Galerie	200-201
Dendhur	202
Varia by SMED	203-205
Nottingham	206

## Contemporary Casegoods (Laminate)

### Sherbrooke

Adjustable Mobile Table	20
Bridge	11
Credenza with Double Pedestal	13
Credenza with Single Pedestal	12
Corner Keyboard Support	18
Diskette/CD Bin	19
Double Pedestal Desk	10
D-Top Convergents	15
D-Top Desks	15
Executive Return	11
Extended Corner Shell	14
Five-High Bookcase	18
Four-High Bookcase	17
General Specifications	7-8
Grommet	19
Lateral File	17
Mobile Pedestal	17
Pencil Drawer	18
Pop-up Power and Data Module	19
Rectangular Conference Table	20
Round Conference Table	20
Self-Adhesive Wiring Channel	19
Single Pedestal Desk	9
Sliding Keyboard Tray	18
Storage/Lateral File Unit	17
Tackboard	18
Task Light	16
Vertical Storage Unit	16

## Contemporary Casegoods (Wood)

### Orlando by SMED

Adjustable Keyboard Pad	41
Adjustable Shelf	34
Bridge	29
“Bumper” Docking Table	40
Cable Management	21-22
Center Drawer	41
Corner Unit without Modesty Panels	29
Credenza with Asymmetrical Kneespace	30
Credenza with Lateral Storage	30
Credenza with Symmetrical Kneespace	31
D-Top Desk	26
Desk-Height Return with Lateral Storage	28
Desk-Height Return with Pedestal Storage	28
Diskette Bin	35
Door/Drawer Credenza	31
Double Pedestal Desk, Flush Top	27
Double Pedestal Desk, Overhang Top	27
Edge/Drawer Pull/Leg Detail	24
Five-High Bookcase	37
Fixed-Intensity Task Lighting (Wood Bottom Vertical Storage Unit)	33
Four Door Vertical Storage Unit	32
General Guidelines for Product Specification	25
Grid	34
Grommet	41
Lateral File Mounted Bookcase	36
Lock Programs	25
Mailbox	34
Multi-Purpose Storage Bins	35
Power Domes	42
Product Offering	21
“Putter” Mobile Pedestal	39
Reference Tray	35
Round Tables	40
“Scooch” Mobile Laptop Caddy	39
Single Pedestal Desk, Flush Top	26
Single Pedestal Desk, Overhang Top	26
Storage Capacities	22-23
Storage Options	23
Tackboard	34
Tackstrip	35
Tag for Ordering	25
Technical Specifications	24
Three-High Bookcase	37
“Tugger” Mobile Computer Table	39
Two Door Vertical Storage Unit	33
Two-High Lateral File	36
Vertical Storage Unit — Open Center Storage	33
Wardrobe/File Storage Cabinet	38
Wardrobe/Storage Cabinet	38
Wire Channel	42

# Table of Contents

Wire Management Arc .....	42	Return .....	60
Wrist Support .....	41	Shelf .....	75, 77
<b>Tripoli by SMED</b>		Single Pedestal Desk with Full-Height Pedestal .....	48
Adjustable Keyboard Pad .....	78	Single Pedestal Desk with Bow Front Full-Height Pedestal .....	48
Box/Box/File Pedestal .....	70	Storage Compartment .....	71
Bridge .....	61	Table Desk .....	47
Cabinet .....	69	Tackboard -- Wall Mount .....	64
Center Drawer .....	78	Three-High Lateral File .....	72
Conference Buffet .....	80	Three-High Lateral File with Storage Compartment .....	73
Conference Caddy .....	80	Two-High Bookcase .....	74
Convenience Outlet Strip .....	78	Two-High Lateral File .....	72
Corner Unit .....	67	Two-High Lateral File with Storage Compartment .....	73
Corner Vertical Storage Unit .....	67	U-Station with Full-Height Pedestals .....	51
Corner Vertical Storage Unit Tackboard .....	68	Vertical Storage Unit .....	62
CRT Table .....	68	Vertical Storage Unit -- Tackboards .....	62
D-Top Desk Extension .....	56	Video Cabinet .....	77
D-Top Desk Extension with End Panel .....	56	Wire Channel .....	79
D-Top Desk with Modesty Panel .....	57	Wrist Support .....	78
Desk and Credenza Shells .....	54	16 1/2" Pedestal Drawer Accessories .....	79
Desk with Bow Front Shell .....	55	64"(1626mm) Storage Cabinet .....	76
Door/Drawer Credenza with Full-Height Pedestals .....	52	64"(1626mm) Wardrobe/Storage Cabinet .....	76
Double Pedestal Desk with Full-Height Pedestals .....	49	64"(1626mm) Wardrobe Cabinet .....	76
Double Pedestal Desk with Bow Front Full-Height Pedestals .....	49	64"(1626mm) Individual Wardrobe Cabinet .....	77
Double File Credenza .....	53	64"(1626mm) Individual Storage Cabinet .....	77
File/File Pedestal .....	70	<b>PLACES® Wood Casegoods</b>	
Filler Strip .....	61	Adjustable Keyboard Pads .....	103
Filing Capacities for Modular/Steel Pedestal Files/Lateral Files; Drawer Dimensions .....	45	Bookcases .....	104-105
Filing Capacities for Wood Pedestal Files/Lateral Files; Drawer Dimensions .....	46	Convergenets, D-Shaped with Modesty Panel .....	95
Five-High Bookcase .....	75	Convergenets, Fixed Height .....	95
Fixed-Intensity Task Lighting .....	63, 67	Credenza Cases, Full-Height Back Panel .....	92
Four Door Credenza .....	53	Credenzas, Full-Height Back Panel, Standard Pedestals .....	93
Four-High Bookcase .....	74	Credenzas, Full-Height Back Panel, Standard Pedestals - Lateral Files .....	94
Four-High Lateral File .....	72	Desk-Height Bridges .....	91
General Information and Guidelines for Product Specification .....	43-44	Desk-Height Return Cases .....	89
Grommet .....	79	Desk-Height Returns .....	90
Keyboard Pullout Tray .....	78	Desk Shells, Full-Height Modesty Panel .....	86
Kneespace Credenza with Full-Height Pedestals .....	52	Double Pedestal Desks, Full-Height Modesty Panel .....	88
L-Desk with Full-Height Pedestals .....	50	File Conversion Kit .....	108
Lateral File .....	71	Fixed-Intensity Task Lighting .....	98
Lateral File Accessories .....	79	Front-to-Back Hanging Bars .....	108
Mobile Pedestal .....	71	Full-Height Modesty Panels, 90° Corners .....	95
Overhead Cabinet .....	63	General Specifications .....	83-84
Overhead Cabinet with Shelves .....	64	Lateral Files .....	108
P-Top Desk Extension .....	58	Pedestal/Desk Accessories .....	109
P-Top Desk Extension with End Panel .....	58	Pedestals, Legal-Width .....	101
P-Top Desk with Modesty Panel .....	59	Pedestals, Standard-Width .....	99-100
Pedestal Filler .....	71	Single Pedestal Desks, Full-Height Modesty Panel .....	87
Power Domes .....	78	Storage Units .....	107
Presentation Board .....	81	Table Desks .....	85
Printer Unit .....	68	Task Light Mounting Bracket .....	98
Reception L-Desk .....	65	Undersurface Lateral Files .....	102
Reception U-Desk .....	66	Vertical Storage Unit Accessories .....	98
		Vertical Storage Units, Flipper Door Unit with Tackboards .....	97

# Table of Contents

Vertical Storage Units, Hinged Door Unit with Tackboards . . . . .	96	Radiused End Open Bookcase Deck . . . . .	142
Vertical Storage Unit Template . . . . .	98	Reception - L-Desk . . . . .	125
Wardrobe Units . . . . .	106	Reception - L-Desk Tackboard . . . . .	125
Wardrobe/Storage Unit Shelf . . . . .	107	Reception - U-Desk . . . . .	126
<b>Varia by SMED</b>		Reception - U-Desk Tackboard . . . . .	126
Adjustable Keyboard Pad . . . . .	151	Return Shell . . . . .	120
Bridge . . . . .	122	Return with Lateral File . . . . .	122
Center Pencil Drawer . . . . .	151	Return with Pedestal . . . . .	121
Combination Vertical Storage Unit Tackboard . . . . .	147	Serving Cart . . . . .	149
Combination Vertical Storage Unit - 66"(1676mm) . . . . .	146	Single Door Radiused End Cabinet . . . . .	142
Combination Vertical Storage Unit - 72"(1829mm) . . . . .	146	Single Door Storage Cabinet . . . . .	140
Combination Vertical Storage Unit - 84"(2134mm) . . . . .	146	Single Door Wardrobe . . . . .	140
Combination Vertical Storage Unit - 90"(2286mm) . . . . .	147	Single Pedestal Desk - Flush Top . . . . .	118
Corner Unit . . . . .	137	Single Pedestal Desk - Overhang Top with Bow Front . . . . .	119
Credenza with Asymmetrical Kneespace - Double Hinged Door . . . . .	131	Single Pedestal Desk - with Overhang Top . . . . .	118
Credenza with Asymmetrical Kneespace - Lateral File . . . . .	129	Table Desk . . . . .	114
Credenza with Asymmetrical Kneespace - Pedestal File . . . . .	128	Telephone Stand . . . . .	150
Credenza with Doors . . . . .	135	Two-High Bookcase . . . . .	142
Credenza with Double Hinged Door and Two Lateral Files . . . . .	134	Two-High Lateral File . . . . .	138
Credenza with Double Hinged Door and Two Pedestals . . . . .	136	Two-High Lateral File Hinged Door Cabinet . . . . .	139
Credenza with Lateral File . . . . .	133	Two-High Lateral File Open Bookcase . . . . .	139
Credenza with Lateral File and Two Double Hinged Door Units . . . . .	136	Upper Storage Bookcase Unit . . . . .	144
Credenza with Lateral File and Two Pedestals . . . . .	134	VDT Table . . . . .	137
Credenza with Symmetrical Kneespace . . . . .	127	Vertical Storage Unit Tackboard . . . . .	145
Credenza with Asymmetrical Kneespace - Double Hinged Door/Pedestal . . . . .	132	Vertical Storage Unit - 66"(1676mm) . . . . .	144
Credenza with Asymmetrical Kneespace - Lateral File/Pedestal . . . . .	130	Vertical Storage Unit - 72"(1829mm) . . . . .	144
D-Top Convergent . . . . .	124	Vertical Storage Unit - 84"(2134mm) . . . . .	145
D-Top Desk . . . . .	123	Vertical Storage Unit - 90"(2286mm) . . . . .	145
Double Door Storage Cabinet . . . . .	141	Video Cabinet . . . . .	150
Double Door Wardrobe . . . . .	141	Wire Channel . . . . .	152
Double Door Wardrobe/Storage Cabinet . . . . .	141	Wrist Support . . . . .	151
Double Hinged Door . . . . .	138	<b>Nottingham</b>	
Double Pedestal Desk - Executive Overhang . . . . .	116	Articulating Keyboard Tray . . . . .	166
Double Pedestal Desk - Executive Overhang with Bow Front . . . . .	117	Console Table . . . . .	155
Double Pedestal Desk - Flush Top . . . . .	115	Corner Unit . . . . .	160
Double Pedestal Desk - Overhang Top . . . . .	115	Desk-Height Bridges . . . . .	159
Double Pedestal Desk - Overhang Top with Bow Front . . . . .	116	Desk-Height Return . . . . .	158
Five-High Bookcase . . . . .	142	Door/Drawer Credenzas . . . . .	163
Fixed Intensity Task Lighting . . . . .	148	Double Pedestal Credenza . . . . .	160
Four-High Lateral File . . . . .	138	Double Pedestal Desk — Flush Top . . . . .	156
General Information . . . . .	111-113	Double Pedestal Desk — Overhang Top . . . . .	156
Grommet . . . . .	152	Executive L-Desk . . . . .	161
Hinged Door Cabinet Open Bookcase . . . . .	139	Executive U-Station — Double Pedestal Credenza . . . . .	162
Keyboard Pullout Tray . . . . .	151	Executive U-Station — Single Pedestal Credenza . . . . .	162
Lateral File Accessories . . . . .	152	Extra Keys for Factory Installed Locks . . . . .	166
Lectern . . . . .	149	Four-Door Vertical Storage Unit . . . . .	165
Mobile Pedestal . . . . .	138	Four-High Bookcase . . . . .	164
Overhead Bookcase - Wall Mount . . . . .	143	Four-High Lateral File . . . . .	164
P-Top Convergent . . . . .	124	General Specifications . . . . .	153-154
P-Top Desk . . . . .	123	Keyboard Pullout Tray . . . . .	166
Pencil Tray . . . . .	151	Kneespace Credenzas . . . . .	163
Power Domes . . . . .	152	Open Vertical Storage Unit . . . . .	165
Presentation Board . . . . .	149	Power Domes . . . . .	166
		Presentation Board . . . . .	165

# Table of Contents

Single Pedestal Desks .....	157	<b>Contemporary Occasional Tables (Wood)</b>	
Single Pedestal Credenza .....	160	<b>Tripoli by SMED</b>	
Table Desk .....	155	Coffee Table .....	199
Tackboard .....	165	Corner Table .....	198
Task Light .....	165	Drum Table .....	199
Two-High Bookcase .....	164	End Table .....	197
Two-High Lateral Files .....	164	Rectangular Coffee Table .....	198
VDT Table .....	166	Rectangular Table .....	197
Wardrobe Unit .....	164	<b>Galerie Collection</b>	
Wire Channel .....	166	5800 Series .....	200
Wireway Grommet and Caps .....	166	5900 Series .....	201
<b>Contemporary Conference Tables (Wood)</b>		<b>Dendhur</b>	
<b>Entropy by SMED</b>		Dendhur Group Tables .....	202
Base .....	170	<b>Varia by SMED</b>	
General Specifications .....	167-168	Varia Cube Tables .....	204
Tops .....	169-170	Varia Drum Tables .....	205
<b>Series K/Profile/Tripoli by SMED</b>		Varia Leg Tables .....	203
Cluster Bases .....	181	<b>Traditional Occasional Tables (Wood)</b>	
Cylinder Bases .....	179	<b>Nottingham</b>	
General Specifications .....	171	Coffee Table .....	206
Half Diameter Cylinder Bases .....	180	End Table .....	206
Metal X Base .....	184	<b>Finishes and Fabrics</b>	
Profile Tops .....	174-176	Casegoods/Tables Finish Matrix .....	207-209
Series K Tops .....	172-173	Fabric/Color Legend .....	210-211
Slab Bases .....	183	<b>Customer's Own Material</b>	
Tripoli Tops .....	177-178	COM Data Sheet .....	213
X Bases .....	182	Custom Finish Formulation Data Sheet .....	214
<b>Varia by SMED</b>		General Information .....	212
General Information .....	185-187	<b>Terms of Sale</b>	
Varia Cylinder Bases .....	193	U.S.A. ....	215-216
Varia Slab Bases .....	190	International .....	217-218
Varia Table Tops - Boat .....	188	Lifetime Product Warranty .....	219
Varia Table Tops - Racetrack .....	189	<b>Index</b> .....	220-231
Varia Table Tops - Rectangle .....	189		
Varia Table Tops - Round .....	188		
Varia X and L Bases .....	191-192		
<b>Conference Table Wire Management / Electrical</b>			
Power Hatch - Retrofit Kits .....	194		
PVC Vertical Wire Manager .....	195		
Vertical Cable Chain .....	195		
Wire Channel .....	195		
<b>Traditional Conference Tables (Wood)</b>			
<b>Nottingham</b>			
Rectangle Table .....	196		
Round Table .....	196		

# Sherbrooke

**Product Offering**

The Sherbrooke product offering consists of the following:

Single Pedestal Desk	D-Top Convergent
Double Pedestal Desk	Vertical Storage Unit
Executive Return	Mobile Pedestal
Bridge	Bookcases
Credenza with Single Pedestal	Storage/Lateral File Unit
Credenza with Double Pedestal	Lateral File
Extended Corner Shell	Adjustable Mobile Table
D-Top Desk	Conference Tables

**Accessories**

The Sherbrooke product offering consists of the following accessories; refer to the price list for specification details:

Task Light	Worksurface Grommet
Tackboard	Pop-up Power and Data Module
Sliding Keyboard Tray	Self-Adhesive Wiring Channel
Corner Keyboard Support	
Pencil Drawer	
Diskette and CD Bin	

- Compatible Haworth accessories:  
 Freestanding Jump Stuff, AKPM-17-SL, AKPM-21-SL, and AKPM-23SF (see page 103).

**General Features**

Full-height modesty panels on desks, returns, and bridges.

Desk/Credenza pedestals are 3/4 height and 15 3/4"(400mm) wide.

Mobile pedestals are 27"(686mm) high and 15 3/8"(391mm) wide.

File drawers are high-sided to accept legal or letter hanging files. Twelve-inch drawers will accommodate front-to-back letter or legal filing. All file drawers are provided with one (1) front-to-back filing bar.

Credenza and Return pedestal drawer internal depth is 14 3/4"(374mm).

Desk pedestal drawer internal depth is 20 3/4"(527mm).

Coordinating conference tables are available as well as mobile, adjustable tables.

Adjustable floor glides are standard on all Sherbrooke Casegoods. Glides provide a 1"(25mm) vertical adjustable range.

Sherbrooke product ships assembled except: Extended Corner Shells, D-Top Desks, D-Top Convergents, Bridges, Conference Tables, and Adjustable Tables.

**Cable Management**

Desks and credenzas feature a plastic, U-shaped horizontal flexible wire management channel just below the worksurface. The channel keeps wires out of sight, while the flexible edge provides easy user access to insert or pull out wires as needed. This channel, in addition to flexible plastic grommets located in end, side, or modesty panels also allows users to route wires from unit to unit.

Flexible plastic end, side, or modesty panel mounted grommets have extra large openings to accommodate over-sized equipment plugs. Grommet location varies from product to product.

Worksurface grommets and pop-up power and data modules are field installed as needed.

Vertical Storage Unit features a flexible horizontal wire management pass-through at lower edge of back panel and a centered grommet at the top of the exposed back panel.

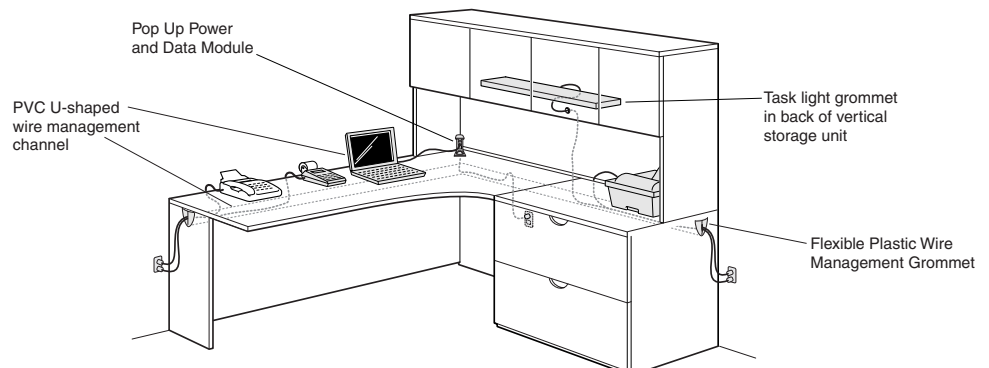

# Sherbrooke

Construction Features	Top and Side Construction	Tops and sides are constructed of a 1 1/4"(32mm) thick thermofused laminate (TFL).
	Modesty Panel	5/8"(16mm) thick thermofused laminate (TFL).
	Door Front Construction	5/8"(16mm) thick thermofused laminate (TFL), with factory installed integral drawer pulls. Drawer pulls are nylon plastic.
	Drawer Box Construction	7/16"(11mm) thick laminated particle board walls on 4 (four) sided drawer box with separately attached drawer fronts.
	Drawer Slides	Box drawers utilize 3/4- extension ball-bearing slides. File drawers utilize full-extension ball-bearing slides.
	Locks	Core-removable locks standard. Lock standard in black finish only. Refer to the Lock Program Specification Guidelines Price List for ordering. Key-alike must be noted on the original order.
	Finish Features	Casegoods are available in solid and wood grain laminates. Units feature plastic solid color matching or contrasting drawer pulls, flexible grommets, or wire management channels.

## Filing Capacities

Pedestal Files — 15 3/4"(400mm) • Applies to separately-specified pedestals and mobile pedestal/return, and pedestals on 66"-wide single- and double-pedestal desks.

17" DEEP PEDESTALS – SEPARATELY SPECIFIED  
PEDESTALS AND MOBILE PEDESTAL/RETURN

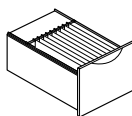

Legal/A4 Filing  
15 3/4"(387mm)

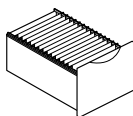

Letter/A4 Filing  
12"(305mm)

Lateral Files — 36"(914mm) Width

• Applies to separately-specified stationary lateral files, and storage/lateral file unit. Adjustable bars are available to accommodate side/side letter filing.

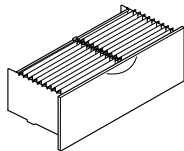

Legal Filing  
30 1/4"(770mm)

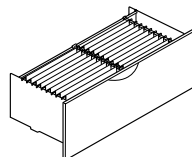

Letter/A4 Filing  
30 1/4"(770mm)

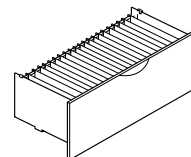

Letter, Legal, and A4 Filing  
32 3/4"(834mm)



# Sherbrooke

	Height	Depth	Width	Number	Price
<b>Single Pedestal Desk</b>	29"(737mm)	30"(762mm)	66"(1676mm)	ZDL-3066	\$874
				ZDR-3066	874
	29"(737mm)	36"(914mm)	72"(1829mm)	ZDL-3672	\$935
				ZDR-3672	935

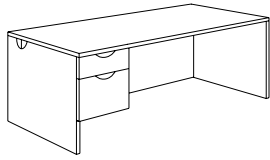

ZDL-3066

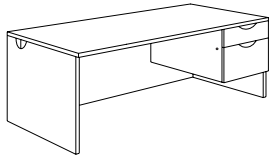

ZDR-3066

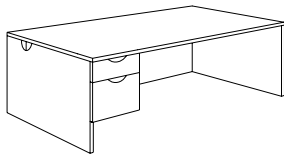

ZDL-3672

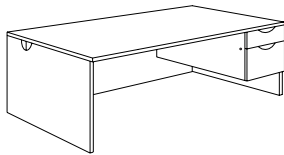

ZDR-3672

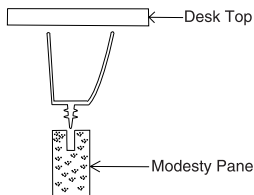

Wire Management Channel Detail

- Solid color laminates have color-matched vinyl edge banding.
- Wood grain laminates have color-matched wood grain vinyl edge banding.
- Edge banding is 2.5mm thick.
- Edge profile is square.
- Pedestal configurations: Box/file with kneewell lock.
- Recessed full-height modesty panel features horizontal continuous wire management channel. This channel, in addition to an end panel flexible plastic grommet, allows users to route wires from unit to unit.
- Flexible plastic end panel grommets have extra large openings to accommodate over-sized equipment plugs.
- Plastic drawer pulls, flexible grommets, and wire management channel are factory installed. Color must be separately specified.
- Drawers feature 3/4 extension ball-bearing slides on box drawers and full extension ball-bearing slides on file drawers.
- Accepts separately specified field installed accessories: pencil drawer, sliding keyboard tray, diskette/CD bin, worksurface grommet, pop-up power and data module, and self-adhesive wiring channel.
- Shipped assembled.

**To Order, Specify:**

- 1) Product number.
- 2) Top laminate color.
- 3) Base laminate color.
- 4) Plastic trim color.

# Sherbrooke

	Height	Depth	Width	Number	Price
<b>Double Pedestal Desk</b>	29"(737mm)	30"(762mm)	66"(1676mm)	ZDD-3066	<b>\$1005</b>
		36"(914mm)	72"(1829mm)	ZDD-3672	<b>1075</b>

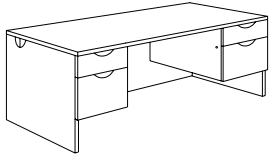

ZDD-3066

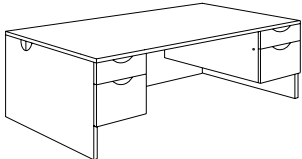

ZDD-3672

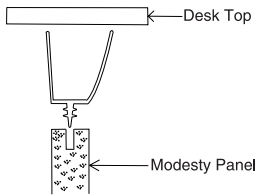

Wire Management Channel Detail

- Solid color laminates have color-matched vinyl edge banding.
- Wood grain laminates have color-matched wood grain vinyl edge banding.
- Edge banding is 2.5mm thick.
- Edge profile is square.
- Pedestal configurations: Box/file with kneewell lock on both sides.
- Recessed full-height modesty panel features horizontal continuous wire management channel. This channel, in addition to flexible plastic grommets in both end panels, allows users to route wires from unit to unit.
- Flexible plastic end panel grommets have extra large openings to accommodate over-sized equipment plugs.
- Plastic drawer pulls, flexible grommets, and wire management channel are factory installed. Color must be separately specified.
- Drawers feature 3/4 extension ball-bearing slides on box drawers and full extension ball-bearing slides on file drawers.
- Accepts separately specified field installed accessories: pencil drawer, sliding keyboard tray, diskette/CD bin, worksurface grommet, pop-up power and data module, and self-adhesive wiring channel.
- Kneespace clearance:
  - 66"(1676mm) desk- 27 3/4"(704mm) high x 26 1/8"(664mm) deep x 34"(864mm) wide.
  - Approach side overhang is 3 1/4"(82mm) deep.
  - 72"(1829mm) desk- 27 3/4"(704mm) high x 26 1/8"(664mm) deep x 40"(1018mm) wide.
  - Approach side overhang is 9 1/4"(234mm) deep.
- Shipped assembled.

**To Order, Specify:**

- 1) Product number.
- 2) Top laminate color.
- 3) Base laminate color.
- 4) Plastic trim color.

# Sherbrooke

	Height	Depth	Width	Number	Price
<b>Executive Return</b>	29"(737mm)	24"(610mm)	48"(1219mm)	ZRL-2448	\$646
				ZRR-2448	646

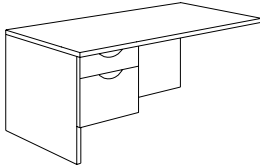

ZRL-2448

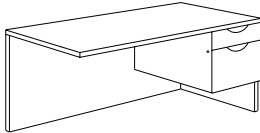

ZRR-2448

- Solid color laminates have color-matched vinyl edge banding.
- Wood grain laminates have color-matched wood grain vinyl edge banding.
- Edge banding is 2.5mm thick.
- Edge profile is square.
- Pedestal configurations: Box/file with kneewell lock.
- Attachment hardware included.
- Flexible plastic grommet in modesty panel is factory installed. Color must be separately specified.
- Plastic drawer pulls, flexible grommets, and wire management channel are factory installed. Color must be separately specified.
- Drawers feature 3/4 extension ball-bearing slides on box drawers and full extension ball-bearing slides on file drawers.
- Accepts separately specified field installed accessories: pencil drawer, sliding keyboard tray, diskette/CD bin, worksurface grommet, pop-up power and data module, and self-adhesive wiring channel.
- Shipped assembled.

**To Order, Specify:**

- 1) Product number.
- 2) Top laminate color.
- 3) Base laminate color.
- 4) Plastic trim color.

<b>Bridge</b>	29"(737mm)	24"(610mm)	48"(1219mm)	ZBR-2448	\$323
---------------	------------	------------	-------------	----------	-------

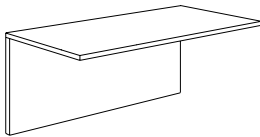

ZBR-2448

- Solid color laminates have color-matched vinyl edge banding.
- Wood grain laminates have color-matched wood grain vinyl edge banding.
- Edge banding is 2.5mm thick.
- Edge profile is square.
- Attachment hardware included.
- Flexible plastic grommet in modesty panel is factory installed. Color must be separately specified.
- Must be supported by freestanding components on both ends.
- Not to be used with Vertical Storage Unit.
- Shipped unassembled.

**To Order, Specify:**

- 1) Product number.
- 2) Top laminate color.
- 3) Base laminate color.
- 4) Plastic trim color.

# Sherbrooke

	Height	Depth	Width	Number	Price
<b>Credenza with Single Pedestal</b>	29"(737mm)	24"(610mm)	66"(1676mm)	ZCL-2466	<b>\$789</b>
				ZCR-2466	<b>789</b>
	29"(737mm)	24"(610mm)	72"(1829mm)	ZCL-2472	<b>\$820</b>
				ZCR-2472	<b>820</b>

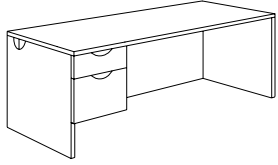

ZCL-2466

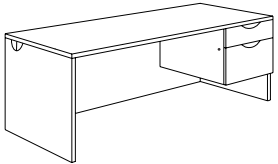

ZCR-2466

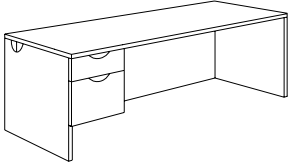

ZCL-2472

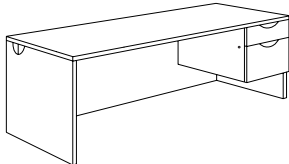

ZCR-2472

- Solid color laminates have color-matched vinyl edge banding.
- Wood grain laminates have color-matched wood grain vinyl edge banding.
- Edge banding is 2.5mm thick.
- Edge profile is square.
- Pedestal configurations: Box/file with kneewell lock.
- Flush full-height modesty panel features horizontal continuous wire management channel. This channel, in addition to an end panel flexible plastic grommet, allows users to route wires from unit to unit.
- Flexible plastic end panel grommets have extra large openings to accommodate over-sized equipment plugs.
- Plastic drawer pulls, flexible grommets, and wire management channel are factory installed. Color must be separately specified.
- Drawers feature 3/4 extension ball-bearing slides on box drawers and full extension ball-bearing slides on file drawers.
- Accepts separately specified field installed accessories: pencil drawer, sliding keyboard tray, diskette/CD bin, worksurface grommet, pop-up power and data module, and self-adhesive wiring channel.
- Shipped assembled.

### To Order, Specify:

- 1) Product number.
- 2) Top laminate color.
- 3) Base laminate color.
- 4) Plastic trim color.

# Sherbrooke

	Height	Depth	Width	Number	Price
<b>Credenza with Double Pedestal</b>	29"(737mm)	24"(610mm)	66"(1676mm)	ZCD-2466	\$ 994
			72"(1829mm)	ZCD-2472	1024

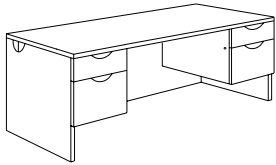

ZCD-2466

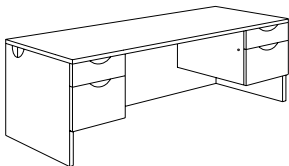

ZCD-2472

- Solid color laminates have color-matched vinyl edge banding.
- Wood grain laminates have color-matched wood grain vinyl edge banding.
- Edge banding is 2.5mm thick.
- Edge profile is square.
- Pedestal configurations: Box/file with kneewell lock on both sides.
- Flush full-height modesty panel features horizontal continuous wire management channel. This channel, in addition to an end panel flexible plastic grommet, allows users to route wires from unit to unit.
- Flexible plastic end and side panel grommets have extra large openings to accommodate over-sized equipment plugs.
- Plastic drawer pulls, flexible grommets, and wire management channel are factory installed. Color must be separately specified.
- Drawers feature 3/4 extension ball-bearing slides on box drawers and full extension ball-bearing slides on file drawers.
- Accepts separately specified field installed accessories: pencil drawer, sliding keyboard tray, diskette/CD bin, worksurface grommet, pop-up power and data module, and self-adhesive wiring channel.
- Kneespace clearance:  
 66"(1676mm) credenza- 27 3/4"(704mm) high x 22 5/8"(574mm) deep x 34"(864mm) wide.  
 72"(1829mm) credenza- 27 3/4"(704mm) high x 22 5/8"(574mm) deep x 40"(1018mm) wide.
- Shipped assembled.

**To Order, Specify:**

- 1) Product number.
- 2) Top laminate color.
- 3) Base laminate color.
- 4) Plastic trim color.

# Sherbrooke

	Height	Depth	Width	Length	Number	Price
<b>Extended Corner Shell</b>	29"(737mm)	24"(610mm)	36"(914mm)	72"(1829mm)	ZEL-2472	\$720
					ZER-2472	720

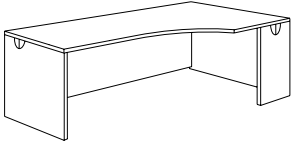

ZEL-2472

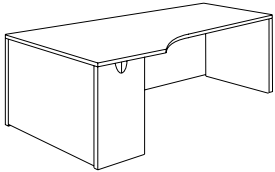

ZER-2472

- Solid color laminates have color-matched vinyl edge banding.
- Wood grain laminates have color-matched wood grain vinyl edge banding.
- Edge banding is 2.5mm thick.
- Edge profile is square.
- Flush full-height modesty panel features horizontal continuous wire management channel. This channel, in addition to an end panel flexible plastic grommet, allows users to route wires from unit to unit.
- Designed for use with bridge, return, or credenza.
- Unit comes with one full panel and one half end panel. End panels are interchangeable.
- Modesty panel features a flexible horizontal plastic U-shaped wire management channel at the top of the panel just below the worksurface.
- Flexible plastic grommets in end panels are factory installed. Color must be separately specified.
- Flexible plastic end panel grommets have extra large openings to accommodate over-sized equipment plugs.
- Can accommodate a 72" wide vertical storage unit.
- Can be used with separately specified mobile pedestal.
- Shipped unassembled.

### To Order, Specify:

- 1) Product number.
- 2) Top laminate color.
- 3) Base laminate color.
- 4) Plastic trim color.

# Sherbrooke

	Height	Depth	Width	Number	Price
<b>D-Top Desks</b>	29"(737mm)	30"(762mm)	66"(1676mm)	ZDE-3066	\$519
	29"(737mm)	36"(914mm)	72"(1829mm)	ZDE-3672	625

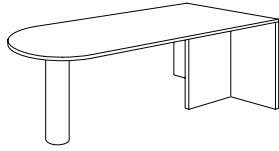

ZDE-3066

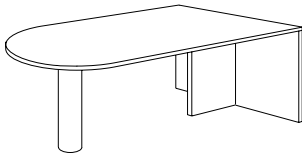

ZDE-3672

- Solid color laminates have color-matched vinyl edge banding.
- Wood grain laminates have color-matched wood grain vinyl edge banding.
- Edge banding is 2.5mm thick.
- Edge profile is square.
- Attachment brackets included.
- Glide on leg has 1"(25mm) adjustment range.
- Flexible plastic grommets in end panels are factory installed. Color must be separately specified.
- Column is standard in black finish only.
- Flexible plastic end panel grommets have extra large openings to accommodate over-sized equipment plugs.
- Shipped unassembled.

**To Order, Specify:**

- 1) Product number.
- 2) Top laminate color.
- 3) Base laminate color.
- 4) Plastic trim color.

<b>D-Top Convergents</b>	29"(737mm)	30"(762mm)	66"(1676mm)	ZDC-3066	\$448
	29"(737mm)	36"(914mm)	72"(1829mm)	ZDC-3672	598

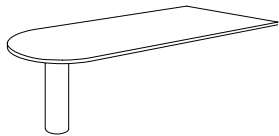

ZDC-3066

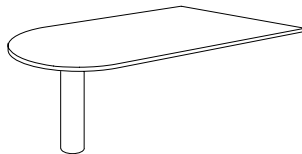

ZDC-3672

- Solid color laminates have color-matched vinyl edge banding.
- Wood grain laminates have color-matched wood grain vinyl edge banding.
- Edge banding is 2.5mm thick.
- Edge profile is square.
- Must be supported by freestanding components.
- Attachment brackets included.
- Glide on leg has 1"(25mm) adjustment range.
- Column is standard in black finish only.
- Shipped unassembled.

**To Order, Specify:**

- 1) Product number.
- 2) Top laminate color.

# Sherbrooke

	Height	Depth	Width	Number	Price
<b>Vertical Storage Unit</b>	35"(889mm)	15"(381mm)	66"(1676mm)	ZVS-3566	\$ 761
			72"(1829mm)	ZVS-3572	923
	39"(991mm)	15"(381mm)	66"(1676mm)	ZVS-3966	\$ 913
			72"(1829mm)	ZVS-3972	1108

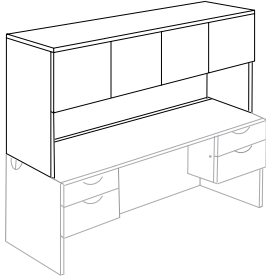

ZVS-3566  
ZVS-3966

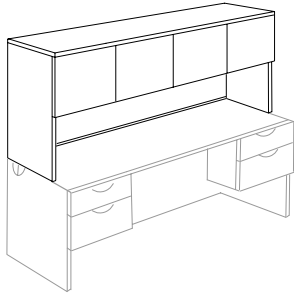

ZVS-3572  
ZVS-3972

- Mounts on top of same width credenza, extended corner shell, or desk.
- Cabinet doors extend below interior shelf for easy opening.
- Two paired left and right hand 135° hinge door sets per unit.
- May not span over two separate base units.
- Back panel features a centered grommet at the top of the exposed back panel and a flexible horizontal wire management pass-through at the base of the back panel. Cords can be easily dropped behind the unit.
- Color for plastic horizontal wire management pass-through must be separately specified. Back panel upper grommet in black only.
- Accommodates separately specified tackboards and task lights, see below and page 18.
- Non-locking.
- Attachment hardware included.
- Clearance:
  - 35"(889mm) high- 16 7/8"(429mm) from top to base of door.
  - 39"(991mm) high- 20 3/4"(527mm) from top to base of door .
- Shipped assembled.

### To Order, Specify:

- 1) Product number.
- 2) Top laminate color.
- 3) Base laminate color.
- 4) Plastic trim color.

	Height	Depth	Width	Number	Price
<b>Task Light</b>	2"(51mm)	7"(178mm)	48"(1219mm)	ZTL-48	\$232

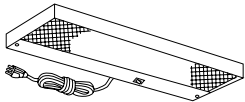

ZTL-48

- Standard in black finish color only.
- Includes mounting hardware.
- Provides task lighting beneath vertical storage unit.
- Requires field installation.

### To Order, Specify:

- 1) Product number.  
(No finish specification required.)



# Sherbrooke

	Height	Depth	Width	Number	Price
--	--------	-------	-------	--------	-------

**Mobile Pedestal**

27"(687mm)      17"(435mm)      15 3/4"(400mm)

ZMP-1827

\$595



ZMP-1827

- Box/box/file only.
- Mobile pedestals can be ordered with contrasting plastic trim color (drawer handles). Color must be separately specified.
- Contrasting top and base is not available.
- Standard with black casters.
- File drawer has fifth caster for anti-tipping.
- Shipped assembled.

**To Order, Specify:**

- 1) Product number.
- 2) Base laminate color.
- 3) Plastic trim color.

**Lateral File**

29"(737mm)      24"(610mm)      36"(914mm)

ZLF-2436

\$751

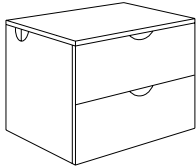

ZLF-2436

- Solid color laminates have color-matched vinyl edge banding.
- Wood grain laminates have color-matched wood grain vinyl edge banding.
- Edge banding is 2.5mm thick.
- Edge profile is square.
- Flexible plastic end and side panel grommets have extra large openings to accommodate over-sized equipment plugs.
- Plastic drawer pulls, flexible grommets, and wire management channel are factory installed. Color must be separately specified.
- Shipped assembled.

**To Order, Specify:**

- 1) Product number.
- 2) Top laminate color.
- 3) Base laminate color.
- 4) Plastic trim color.

**Storage/Lateral File Unit**

64"(1626mm)      24"(610mm)      36"(914mm)

ZSL-3664

\$1350

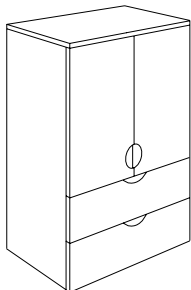

ZSL-3664

- Includes 2 (two) full-width adjustable shelves inside top storage cabinet.
- Shelves adjustable in 3 3/4"(95mm) increments.
- 27 3/4"(705mm) high lower lateral file is locking; 35 3/4"(908mm) high top storage cabinets are non-locking.
- Includes glides.
- Shipped assembled.
- Plastic drawer pulls are factory installed. Color must be separately specified.

**To Order, Specify:**

- 1) Product number.
- 2) Top laminate color.
- 3) Base laminate color.
- 4) Plastic trim color.

**Four-High Bookcase**

50"(1270mm)      12"(305mm)      36"(914 mm)

ZBC-3650

\$438

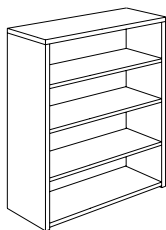



ZBC-3650

- Includes three (3) adjustable shelves, with 1 1/4"(32mm) incremental adjustment.
- Bookcase top and base can be ordered in contrasting colors.
- Includes glides.
- Shipped assembled.

**To Order, Specify:**

- 1) Product number.
- 2) Top laminate color.
- 3) Base laminate color.

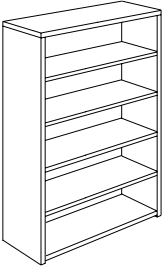
# Sherbrooke

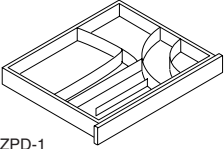
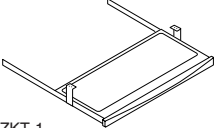
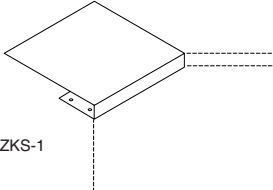
	Height	Depth	Width	Number	Price
<b>Five-High Bookcase</b>  ZBC-3664	64"(1626mm)	12"(305mm)	36"(914 mm)	ZBC-3664	\$557
<ul style="list-style-type: none"> <li>Includes four (4) adjustable shelves, with 1 1/4"(32mm) incremental adjustment.</li> <li>Bookcase top and base can be ordered in contrasting colors.</li> <li>Includes glides.</li> <li>Shipped assembled.</li> </ul>	<b>To Order, Specify:</b> <ol style="list-style-type: none"> <li>Product number.</li> <li>Top laminate color.</li> <li>Base laminate color.</li> </ol>				
<b>Tackboard</b>  ZTB-66   ZTB-72	14"(356mm)		66"(1676mm) 72"(1829mm)	ZTB-66 ZTB-72	\$264 285
<ul style="list-style-type: none"> <li>Includes one (1) tackboard and mounting hardware.</li> <li>Mounts on a vertical storage unit back panel only.</li> <li>Requires field installation.</li> <li>COM fabrics are not available.</li> </ul>	<b>To Order, Specify:</b> <ol style="list-style-type: none"> <li>Product number.</li> <li>Fabric surface and color.</li> </ol>				
<b>Pencil Drawer</b>  ZPD-1	2 1/2"(64mm)	16 1/2"(419mm)	20"(508mm)	ZPD-1	\$96
<ul style="list-style-type: none"> <li>Standard in black finish color only.</li> <li>Mounting hardware included.</li> <li>Requires field installation.</li> </ul>	<b>To Order, Specify:</b> <ol style="list-style-type: none"> <li>Product number. (No finish specification required.)</li> </ol>				
<b>Sliding Keyboard Tray</b>  ZKT-1	4"(102mm)	15"(381mm)	22"(559mm)	ZKT-1	\$90
<ul style="list-style-type: none"> <li>Standard in black finish color only.</li> <li>Mounting hardware included.</li> <li>Requires field installation.</li> </ul>	<b>To Order, Specify:</b> <ol style="list-style-type: none"> <li>Product number. (No finish specification required.)</li> </ol>				
<b>Corner Keyboard Support</b>  ZKS-1	1 1/2"(38mm)	18"(457mm)	18"(457mm)	ZKS-1	\$162
<ul style="list-style-type: none"> <li>Standard in black finish color only.</li> <li>Recommended for use with return and bridge.</li> <li>Requires field installation.</li> </ul>	<b>To Order, Specify:</b> <ol style="list-style-type: none"> <li>Product number. (No finish specification required.)</li> </ol>				

# Sherbrooke

	Height	Depth	Width	Number	Price
--	--------	-------	-------	--------	-------

**Diskette/CD Bin**

5 1/2"(140mm)      5 1/2"(140mm)      13"(330mm)

ZDB-1

\$16

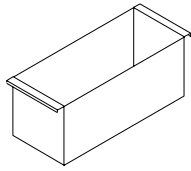

- Standard in black finish color only.
- Fits inside pedestal drawer, no mounting hardware required.
- Requires field installation.

**To Order, Specify:**

- 1) Product number.  
(No finish specification required.)

ZDB-1

**Pop-up Power and Data Module**

8 3/4"(222mm)      3"(76mm)      4 1/2"(114mm)

ZPM-1

\$199

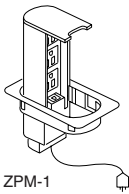

- Standard in black finish color only.
- Features duplex outlet with data ports.
- Communication opening accepts AMP or Panduit products.
- Requires field installation, template provided.
- Communication information and standard outlet plates are not provided by Haworth and must be purchased separately from respective manufacturers.

**To Order, Specify:**

- 1) Product number.  
(No finish specification required.)

ZPM-1

**Self-Adhesive Wiring Channel**

72"(1829mm)

ZWM-72

\$108

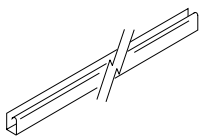

- Standard in black finish color only.
- Cut to size.
- Installation adhesive included.
- Requires field installation.

**To Order, Specify:**

- 1) Product number.  
(No finish specification required.)

ZWM-72

**Grommet**

Height	Inside Diameter	Outside Diameter	Number	Price
--------	-----------------	------------------	--------	-------

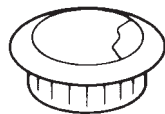

1"(25mm)      2 3/4"(70mm)      3"(76mm)

WSG-1

\$11

- Standard in black finish color only.
- Requires field installation.

**To Order, Specify:**

- 1) Product number.  
(No finish specification required.)

WSG-1

# Sherbrooke

	Height	Diameter	Number	Price
<b>Adjustable Mobile Table</b>	21"-31"(533-787mm)	30"(762mm)	ZAT-3030	\$516



ZAT-3030

- Star base and column are standard in black finish only.
- Non-locking casters included.
- Lever height adjustable.
- Shipped unassembled.

**To Order, Specify:**

- 1) Product number.
- 2) Top laminate color.

<b>Round Conference Table</b>	29"(737mm)	42"(1067mm)	ZRT-42	\$576
-------------------------------	------------	-------------	--------	-------



ZRT-42

- All conference table tops have color-matched wood grain 2.5mm edge banding.
- Conference table top and base can be ordered in contrasting colors.
- Adjustable glides.
- X-shaped base.
- Shipped unassembled.

**To Order, Specify:**

- 1) Product number.
- 2) Top laminate color.
- 3) Base laminate color.

	Height	Depth	Width	Number	Price
<b>Rectangular Conference Table</b>	29"(737mm)	36"(914mm)	72"(1829mm)	ZTC-3672	\$609
		48"(1219mm)	96"(2438mm)	ZTC-4896	786

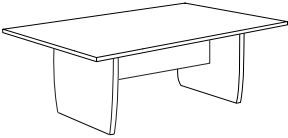

ZTC-3672

- All conference table tops have color-matched or color-matched wood grain 2.5mm edge banding.
- Conference table top and base can be ordered in contrasting colors.
- Adjustable glides.
- Shipped unassembled.

**To Order, Specify:**

- 1) Product number.
- 2) Top laminate color.
- 3) Base laminate color.

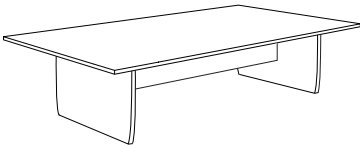

ZTC-4896

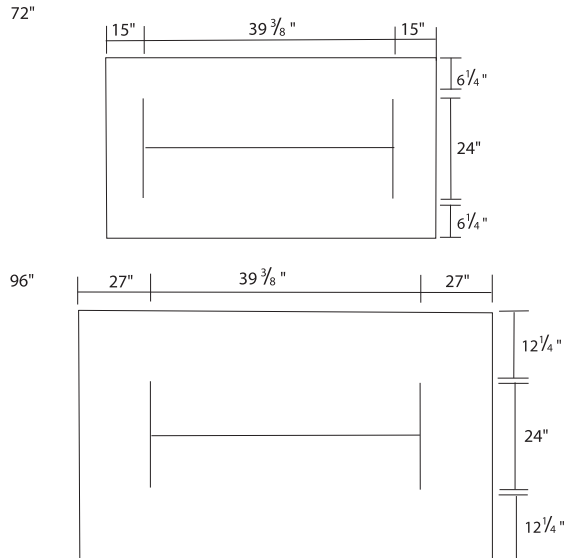

# Orlando by SMED

**Product Offering**

The Orlando casegoods and tables product offering consists of the following:

Single Pedestal Desks	D-Top Desks	Wardrobe/Storage Cabinets
Double Pedestal Desks	Corner Units	Pedestal
Credenzas	Vertical Storage Units	Mobile Computer Table
Returns	Bookcases	Mobile Laptop Caddy
Bridges	Lateral Files	Tables

**Cable Management**

To help you route power cords and communication cables around and through Orlando casegoods, we have designed several features into the products. We also offer several accessory products to bring electrical power and data to the desk height and route cords and cables down and around the product.

Desks, returns, bridges and credenzas feature a continuous 1"(25mm) space between the modesty panel and the desk top to allow routing of cords and cables. A crescent-shaped cutout centered in the top edge of the modesty panel allows pass through of large power plugs.

Vertical storage units feature a continuous 1 1/2"(38mm) space between the top of the back panel and the bottom of the cabinet. This allows for routing of the task light power cord behind the back panel, and it also functions as the attachment location for a tackboard or grid. Additional power cords and communications cables can be routed through two crescent-shaped cutouts in the bottom edge of the back panel.

Returns, bridges, and kneespace credenzas feature modesties that are easily detached for power. Details on how to specify this option are included on the appropriate price pages.

Another built-in cable routing feature is a cutout in the top corner of the pedestal and lateral file side panel within the kneewell. Used in conjunction with a field-installed grommet over a pedestal or lateral file case to route cords and cables from the desk top to the kneewell space of the casegood. For the convenience of desk-height power, a power and data dome can be field installed into a 3" opening in any casegoods top. The black half-sphere provides four receptacle sites or two data and two power sites. The power dome's 15-amp plugs can be connected to a building electrical outlet or Haworth systems panel receptacle.

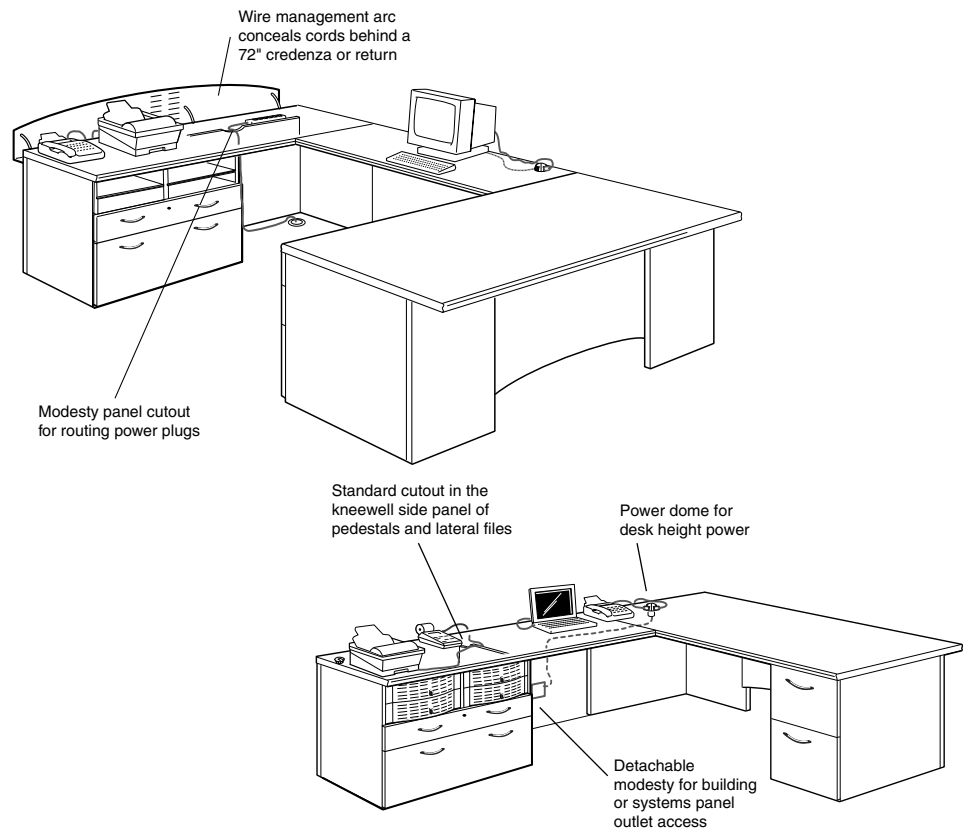

# Orlando by SMED

## Cable Management continued . . .

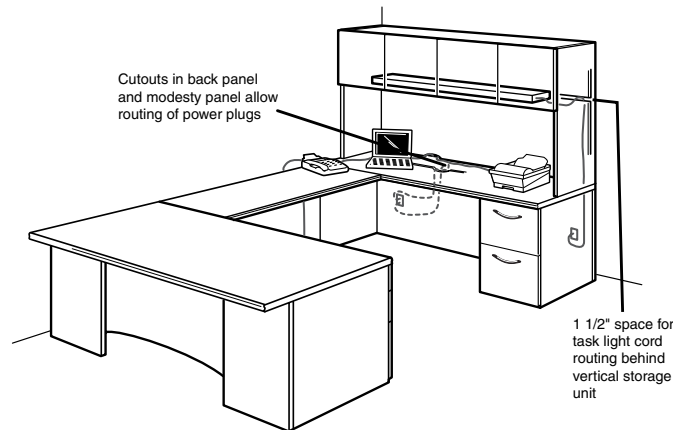

## Storage Capacities

Orlando offers several standard storage features as well as some unique storage options. All desk, return and credenza pedestal file drawers offer full-extension interior drawer access to front-to-back letter filing or side-to-side legal filing. Box drawers offer 3/4-extension interior drawer access.

Standard pedestal accessories include one (1) pencil tray per pedestal in top 6" drawer, and one (1) divider for every 6" box drawer.

Lateral file drawers are available in two heights, 6" and 12". Six inch drawers will accommodate boxes of computer disks or CD jewel cases standing on end. Twelve inch drawers will accommodate front-to-back letter or legal filing or side-to-side legal filing. Each 12" lateral file drawer is provided with two (2) front-to-back filing bars.

In addition to offering standard pedestals and two-drawer lateral files, a unique combination of open shelves and project drawers are available with the standard box/file and lateral file drawers. Desks and returns offer an open storage shelf with one divider above a box/file pedestal. Returns and credenzas offer two options; side-by-side open storage shelves with dividers above a 6"-high and 12"-high lateral file combination, and side-by-side double project drawers above a 6"-high and 12"-high lateral file combination.

### Pedestal Files — 16 3/8" (415mm) Width

- Applies to separately-specified pedestals and mobile pedestal/return, and pedestals on 66"-wide single- and double-pedestal desks.

#### 20" DEEP PEDESTALS – SEPARATELY SPECIFIED PEDESTALS AND MOBILE PEDESTAL/RETURN

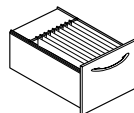

Legal/A4 Filing  
12 7/8" (326mm)

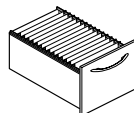

Letter/A4 Filing  
15 7/8" (392mm)

#### 26" DEEP PEDESTALS – 66"-WIDE DESKS

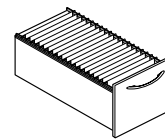

Letter/A4 Filing  
21" (532mm)

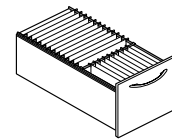

Legal/A4 and Letter Filing  
18 3/8" (466mm)

### Lateral Files — 36" (914mm) Width

- Applies to separately-specified stationary lateral files, and lateral files on returns and credenzas.

- Adjustable bars are included to accommodate side/side letter filing.

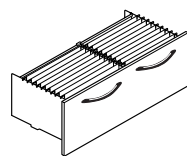

Legal Filing  
30 1/4" (770mm)

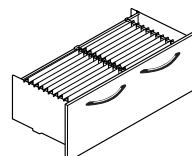

Letter/A4 Filing  
30 1/4" (770mm)

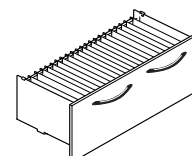

Letter, Legal, and A4 Filing  
32 3/4" (834mm)

# Orlando by SMED

**Storage Capacities**  
continued . . .

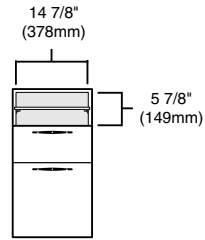



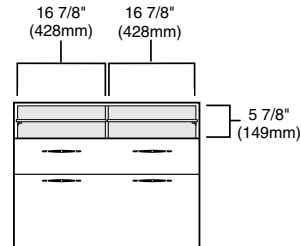

Pedestal storage shelf dimensions



Lateral storage shelf dimensions

**Storage Options**

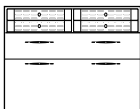
Option	Desks	Returns	Credenzas	Wardrobe/Storage Cabinets
	X	X	X	X
	X			
	X	X		
		X	X	
		X	X	
		X	X	

# Orlando by SMED

## Technical Specifications

Top Construction	1 1/4"(31mm) thick	medium-density particle board core, wood veneer or plastic laminate on top and backer sheet, solid wood edges
Modesty panel	3/4"(19mm)	medium-density particle board core with wood veneer surfaces
End Panel Construction	1 1/4"(31mm) thick	medium-density particle board core with wood veneer surfaces
Drawer Front Construction		Pedestal box and file drawers: medium-density particle board core with wood veneer surface Lateral file drawers: particle board core with wood veneer surface Project drawers: Steel with powder coat finish
Drawer Box Construction		Modular/Steel: 3" Project drawers are steel. 6"(152mm) letter box drawers are modular plastic with spacers for dividers. 12"(305mm) drawers are steel.
Drawer/Door Pulls		zinc die cast, black finish
Veneer		All exposed veneers are plain-sliced and book-matched; drawer fronts, per pedestal, are matched in sets for consistent grain and color. Beech and Anegre are quarter-sliced.
Finishing		2-step finishing process sealed with conversion varnish

Because of the natural properties of wood, variations of grain pattern and finish color can be expected. Materials used in the manufacturing of products are carefully selected to promote consistent and acceptable color. Wood is susceptible to color change from long-term exposure to sunlight.

To keep your wood writing surfaces looking beautiful for the life of the product it is highly recommended that a blotter pad, glass or plexiglass surface be used under writing instruments.

Orlando casegoods are available with three select laminates for use on tops and writing surfaces. Laminates are recommended for severe use applications.

## Edge/Drawer Pull/Leg Detail

All Orlando worksurfaces feature a radiused wood edge on the user's side of the top. Desks also feature the radiused edge on the visitor's side. The other two sides of desks and the three sides of other casegoods feature a square wood edge banding. Bumper and round tables feature the radiused edge on the radiused side. The straight edge of the bumper table features the square edge banding.

Pedestal drawers, lateral file drawers and wardrobe/storage doors feature an easy-to-grab handle which meets ADA guidelines.



Edge Detail

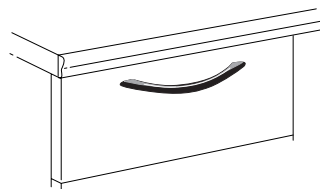

Drawer Pull (Factory installed)

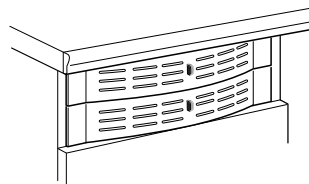

Project Drawer Pulls (Factory installed)

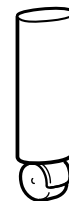

D-Top, Corner and Table Leg



# Orlando by SMED

**General Guidelines for Product Specification**

Orlando product specification numbers are based on an alpha-numeric logic that identifies a product by product line, size and certain characteristics.

For instance, a product number that reads **OCXL-2272-R** identifies the product as an Orlando credenza with lateral storage, 22"(559mm) deep and 72"(1829mm) wide.

The alpha-numeric logic for this product complete with finish color code is shown below:

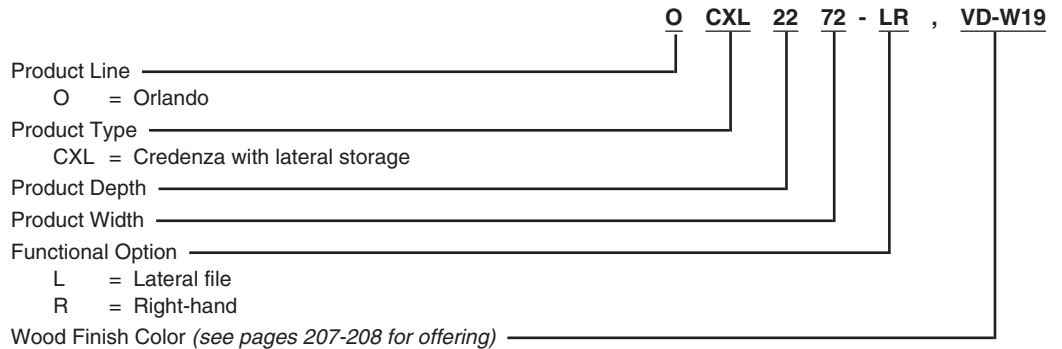

There are exceptions to this logic; therefore, always refer to the price charts for product numbers rather than attempting to construct them. Product number modification instructions for additional options appear in footnoted copy for each applicable product.

Beyond the printed product number, wood finish color and optional surface finish codes are required to complete an order specification. To communicate your order clearly, list the product number and finish codes in the sequence outlined on each price page.

**Tag for Ordering**

Orlando is manufactured so that every piece in an office can be constructed from the same wood flitch. This provides superior color and grain matching. In order to meet these high standards, Haworth requires that all items in the order be tagged with an individual office location. Items will be manufactured, labeled and shipped so that installers can easily identify items by office.

**Finishes**

A complete listing of finishes and fabrics for Orlando casegoods can be found on pages 207-211.

**Lock Programs**

Desks, returns and credenzas with pedestals, wardrobe/storage cabinets, and lateral files each feature one or more locks. Vertical storage units are available with or without locks. Tagged offices will be keyed alike.

All locks will have a bright zinc finish regardless of veneer type or wood finish color.

Refer to the current Lock Programs Specification Guidelines Price List for master keying. Contact the Haworth Order Services Inquiry Center for more information.

# Orlando by SMED

	Height	Depth	Width	Number	Wood Finish Group			
					1	2	3	4

### Single Pedestal Desk, Overhang Top

29 1/4"(745mm)	36"(914mm)	72"(1829mm)	ODOS-3672-		\$1744	\$1836	\$1928	\$2203
----------------	------------	-------------	------------	--	--------	--------	--------	--------

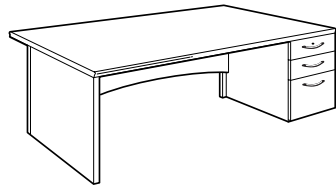

ODOS-3672-HR (Right-hand shown)

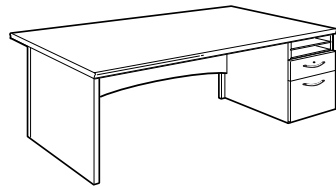

ODOS-3672-KR (Right-hand shown)

- Pedestal configurations: Box/box/file with lock or open storage shelf/box/file with lock.
- Recessed 3/4-height modesty panel with continuous wireway cutout.
- Desk top overhang is 6"(152mm).
- Accommodates these separately-specified accessories: center pencil drawer, grommet, power dome.
- Drawer pulls are standard in black finish color only.
- Kneespace clearance: 28 1/8"(715mm) high x 26 1/2"(673mm) deep x 54 1/2"(1382mm) wide.
- False pedestal back on side with no pedestal provides a double pedestal desk appearance from the approach side.
- Drawer interior is modular/steel.
- Desk shipped unassembled. Storage unit shipped assembled.
- Desks ordered as left- or right-hand cannot be field reconfigured to the opposite orientation.

#### To Order, Specify:

- 1) Product number.  
–Specify storage pedestal as **9th digit** in product number.  

<b>H</b>	Box/box/file
<b>K</b>	Storage shelf/box/file, add \$50 list

 –Specify pedestal orientation as **10th digit** in product number.  

<b>L</b>	Left-hand pedestal
<b>R</b>	Right-hand pedestal
- 2) Wood finish color.
- 3) Plastic laminate finish color (if specified).

### Single Pedestal Desk, Flush Top

29 1/4"(745mm)	30"(762mm)	66"(1676mm)	ODRS-3066-		\$1663	\$1751	\$1839	\$2101
----------------	------------	-------------	------------	--	--------	--------	--------	--------

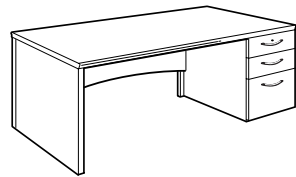

ODRS-3066-HR (Right-hand shown)

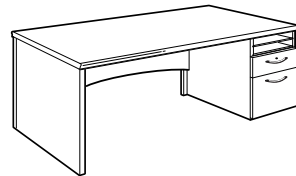

ODRS-3066-KR (Right-hand shown)

- Pedestal configurations: Box/box/file with lock or open storage shelf/box/file with lock.
- Recessed 3/4-height modesty panel with continuous wireway cutout.
- Accommodates these separately-specified accessories: center pencil drawer, grommet, power dome.
- Drawer pulls are standard in black finish color only.
- Kneespace clearance: 28 1/8"(715mm) high x 26 1/2"(673mm) deep x 48 1/2"(1231mm) wide.
- False pedestal back on side with no pedestal provides a double pedestal desk appearance from the approach side.
- Drawer interior is modular/steel.
- Desk shipped unassembled. Storage unit shipped assembled.
- Desks ordered as left- or right-hand cannot be field reconfigured to the opposite orientation.

#### To Order, Specify:

- 1) Product number.  
–Specify storage pedestal as **9th digit** in product number.  

<b>H</b>	Box/box/file
<b>K</b>	Storage shelf/box/file, add \$50 list

 –Specify pedestal orientation as **10th digit** in product number.  

<b>L</b>	Left-hand pedestal
<b>R</b>	Right-hand pedestal
- 2) Wood finish color.
- 3) Plastic laminate finish color (if specified).

### D-Top Desk

29 1/4"(745mm)	36"(914mm)	72"(1829mm)	ORED-3672		\$1721	\$1812	\$1903	\$2174
----------------	------------	-------------	-----------	--	--------	--------	--------	--------

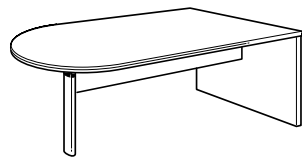

ORED-3672

- Includes full-height end panel, 9"(229mm) high modesty panel and 3"(76mm) elliptical steel support leg.
- Attaches to a return or bridge only and cannot be specified as a freestanding desk.
- Support leg is standard in charcoal finish color only.
- Kneespace clearance: 28 1/8"(715mm) high x 17 1/4"(438mm) deep x 51 3/4"(1314mm) wide.
- Shipped unassembled.

#### To Order, Specify:

- 1) Product number.
- 2) Wood finish color.
- 3) Plastic laminate finish color (if specified).

# Orlando by SMED

	Height	Depth	Width	Number	Wood Finish Group			
					1	2	3	4

**Double Pedestal Desk, Overhang Top**

29 1/4"(745mm)	36"(914mm)	72"(1829mm)	ODOD-3672-	■ ■	\$2001	\$2106	\$2211	\$2527
----------------	------------	-------------	------------	-----	--------	--------	--------	--------

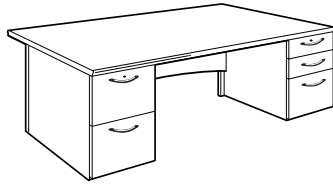

ODOD-3672-JH

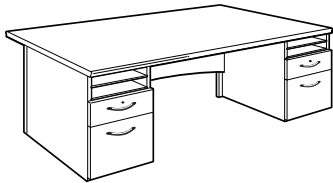

ODOD-3672-KK

- Pedestal configurations: File/file and box/box/file with two locks or open storage shelf/box/file on both sides with two locks.
- Recessed 3/4-height modesty panel with continuous wireway cutout.
- Desk top overhang is 6"(152mm).
- Accommodates these separately-specified accessories: center pencil drawer, grommet, power dome.
- Drawer pulls are standard in black finish color only.
- Kneespace clearance: 28 1/8"(715mm) high x 26 1/2"(673mm) deep x 39 3/8"(999mm) wide.
- Drawer interior is modular/steel.
- Desks shipped unassembled. Storage units shipped assembled.

**To Order, Specify:**

- 1) Product number.  
Pedestal options  
–Specify one of the following pedestal options as a suffix to the product number.  
**JH** 12"/12" drawer pedestal, left and 6"/6"/12" drawer pedestal, right  
**KK** Shelf/shelf/6"/12" drawer pedestals, left and right, add \$100 list
- 2) Wood finish color.
- 3) Plastic laminate finish color (if specified).

**Double Pedestal Desk, Flush Top**

29 1/4"(745mm)	30"(762mm)	60"(1524mm)	ODRD-3060-	■ ■	\$1791	\$1885	\$1979	\$2262
29 1/4"(745mm)	30"(762mm)	66"(1676mm)	ODRD-3066-	■ ■	1890	1990	2090	2388

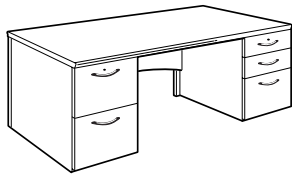

ODRD-3060-JH  
ODRD-3066-JH

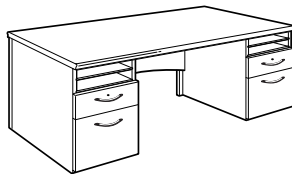

ODRD-3060-KK  
ODRD-3066-KK

- Pedestal configurations: File/file and box/box/file with two locks or open storage shelf/box/file on both sides with two locks.
- Recessed 3/4-height modesty panel with continuous wireway cutout.
- Accommodates these separately-specified accessories: center pencil drawer, grommet, power dome.
- Drawer pulls are standard in black finish color only.
- Kneespace clearance:  
66"(1676mm) desk - 28 1/8"(715mm) high x 26 1/2"(673mm) deep x 33 3/8"(846mm) wide.  
60"(1524mm) desk - 28 1/8"(715mm) high x 26 1/2"(673mm) deep x 27 3/8"(694mm) wide.
- Shelves use matching veneer.
- Drawer interior is modular/steel.
- Desks shipped unassembled. Storage units shipped assembled.

**To Order, Specify:**

- 1) Product number.  
Pedestal options  
–Specify one of the following pedestal options as a suffix to the product number.  
**JH** 12"/12" drawer pedestal, left and 6"/6"/12" drawer pedestal, right  
**KK** Shelf/shelf/6"/12" drawer pedestals, left and right, add \$100 list
- 2) Wood finish color.
- 3) Plastic laminate finish color (if specified).

# Orlando by SMED

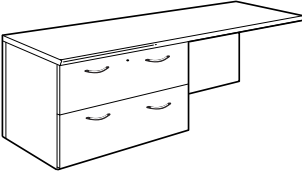
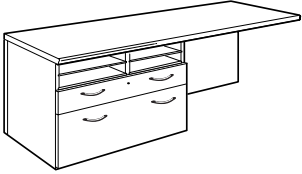
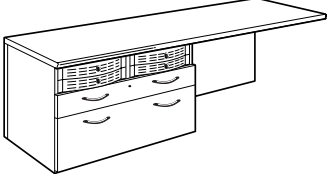
	Height	Depth	Width	Number	Wood Finish Group			
					1	2	3	4
<b>Desk-Height Return with Lateral Storage</b>  ORRL-2272-LLF (Left-hand with modesty shown)  ORRL-2272-MLF (Left-hand with modesty shown)  ORRL-2272-NLF (Left-hand with modesty shown)	29 1/4"(745mm)	22"(559mm)	72"(1829mm)	ORRL-2272-	\$1599	\$1683	\$1767	\$2020
<ul style="list-style-type: none"> <li>Lateral file configurations: (2) lateral files with lock, open storage shelves/6" lateral file/12" lateral file with lock, or metal storage bins/6" lateral file/12" lateral file with lock.</li> <li>Attaches to a single pedestal desk or D-top desk.</li> <li>Attachment hardware included.</li> <li>Kneespace clearance: 28 1/8"(715mm) high x 20"(508mm) deep x 35 5/8"(905mm) wide.</li> <li>Drawer pulls and project drawers are standard in black finish color only.</li> <li>Returns shipped unassembled. Storage unit shipped assembled.</li> <li>Returns ordered as left- or right-hand cannot be field reconfigured to the opposite orientation.</li> </ul>	<b>To Order, Specify:</b> 1) Product number. -Specify lateral file drawer as <b>9th digit</b> in product number. <b>L</b> Lateral file <b>M</b> Shelf/shelf/box/file, add <b>\$150</b> list <b>N</b> Project drawer/project drawer/box/lateral file, add <b>\$648</b> list -Specify desk orientation as <b>10th digit</b> in product number. <b>L</b> Left-handed <b>R</b> Right-handed -Specify modesty panel as <b>11th digit</b> in product number. <b>F</b> Full modesty, add <b>\$50</b> list <b>N</b> No modesty 2) Wood finish color. 3) Plastic laminate finish color (if specified).							

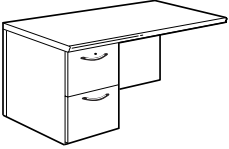
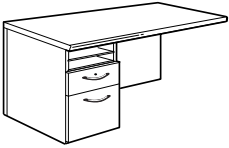
	Height	Depth	Width	Number	Wood Finish Group			
					1	2	3	4
<b>Desk-Height Return with Pedestal Storage</b>  ORRS-2248-JLF (Left-hand with modesty shown)  ORRS-2248-KLF (Left-hand with modesty shown)	29 1/4"(745mm)	22"(559mm)	48"(1219mm)	ORRS-2248-	\$1263	\$1330	\$1397	\$1596
<ul style="list-style-type: none"> <li>Pedestal configurations: File/file with lock or open storage shelf/box/file with lock.</li> <li>Attaches to a single pedestal desk or D-top desk.</li> <li>Attachment hardware included.</li> <li>Drawer pulls are standard in black finish color only.</li> <li>Kneespace clearance: 28 1/8"(715mm) high x 20"(508mm) deep x 31 5/8"(804mm) wide.</li> <li>Returns shipped unassembled. Storage unit shipped assembled.</li> <li>Returns ordered as left- or right-hand cannot be field reconfigured to the opposite orientation.</li> </ul>	<b>To Order, Specify:</b> 1) Product number. -Specify pedestal storage as <b>9th digit</b> in product number. <b>J</b> File/file <b>K</b> Shelf/shelf/box/file, add <b>\$50</b> list -Specify desk orientation as <b>10th digit</b> in product number. <b>L</b> Left-handed <b>R</b> Right-handed -Specify modesty panel as <b>11th digit</b> in product number. <b>F</b> Full modesty, add <b>\$50</b> list <b>N</b> No modesty 2) Wood finish color. 3) Plastic laminate finish color (if specified).							

# Orlando by SMED

	Height	Depth	Width	Number	Wood Finish Group			
					1	2	3	4
<b>Bridge</b>	29 1/4"(745mm)	22"(559mm)	36"(914mm)	OBR-2236-	\$615	\$647	\$679	\$776
	29 1/4"(745mm)	22"(559mm)	48"(1219mm)	OBR-2248-	663	698	733	838

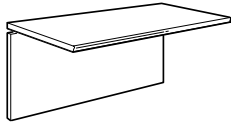

OBR-2236-F  
OBR-2248-F  
(With modesty panel)



OBR-2236-N  
OBR-2248-N  
(Without modesty panel)

- Attaches to a single pedestal desk or D-top desk and single pedestal credenza.
- Attachment hardware included.
- Kneespace clearance: 28 1/8"(715mm) high x 20"(508mm) deep.
- Shipped unassembled.

**To Order, Specify:**

- 1) Product number.  
–Specify modesty panel as **8th digit** in product number.  
**F** Full modesty, add \$50 list  
**N** No modesty
- 2) Wood finish color.
- 3) Plastic laminate finish color (if specified).

**Corner Unit without Modesty Panels**

	29 1/4"(745mm)	22"(559mm)	36"(914mm)	OUC-2236-	\$1235	\$1300	\$1365	\$1560
--	----------------	------------	------------	-----------	--------	--------	--------	--------

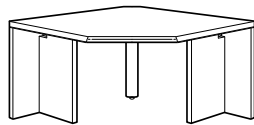

OUC-2236-N

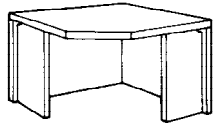

OUC-2236-F

- Includes two full-height end panels.
- Corner unit without modesty panels includes 3"(76mm) elliptical steel support leg.
- Attaches to return or bridge.
- Attachment hardware included.
- Elliptical steel support leg is standard in charcoal finish color only.
- Kneespace clearance: 28 1/8"(715mm) high x 18"(457mm) deep x 23 1/2"(597mm) wide.
- Shipped unassembled.
- Not intended to support a vertical storage unit end panel or bookcase.
- Can accommodate separately-specified field installed grommet.

**To Order, Specify:**

- 1) Product number.  
–Specify modesty panel as **8th digit** in product number.  
**F** Full modesty, add \$100 list  
**N** No modesty
- 2) Wood finish color.
- 3) Plastic laminate finish color (if specified).

# Orlando by SMED

	Height	Depth	Width	Number	Wood Finish Group			
					1	2	3	4
<b>Credenza with Asymmetrical Kneespace</b>	29 1/4"(745mm)	22"(559mm)	66"(1676mm)	OCXS-2266-J	\$1160	\$1221	\$1282	\$1465
	29 1/4"(745mm)	22"(559mm)	72"(1829mm)	OCXS-2272-J	1320	1390	1460	1668

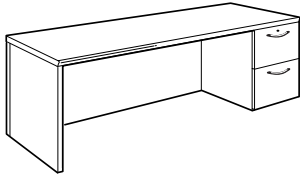

OCXS-2266-JR  
OCXS-2272-JR  
(Right-hand shown)

- Pedestal configurations: File/file with lock.
- Full-height back panel with continuous wireway cutout.
- Drawer pulls are standard in black finish color only.
- Kneespace clearance:  
66"(1676mm) credenza - 28 1/8"(715mm) high x 20"(508mm) deep x 48 1/2"(1231mm) wide.  
72"(1829mm) credenza - 28 1/8"(715mm) high x 20"(508mm) deep x 54 1/2"(1384mm) wide.
- Credenza shipped unassembled. Storage unit shipped assembled.
- Drawer interior is steel.
- Credenzas ordered as left- or right-hand cannot be field reconfigured to the opposite orientation.

**To Order, Specify:**

- 1) Product number.  
–Specify pedestal orientation as **10th digit** in product number.  
**L** Left-hand pedestal  
**R** Right-hand pedestal
- 2) Wood finish color.
- 3) Plastic laminate finish color (if specified).

## Credenza with Lateral Storage

29 1/4"(745mm)	22"(559mm)	72"(1829mm)	OCXL-2272-	\$1697	\$1786	\$1875	\$2143
----------------	------------	-------------	------------	--------	--------	--------	--------

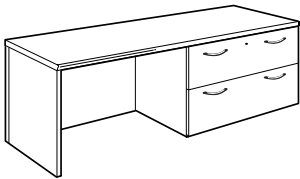

OCXL-2272-LR (Right-hand shown)

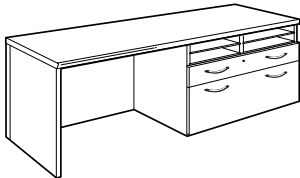

OCXL-2272-MR (Right-hand shown)

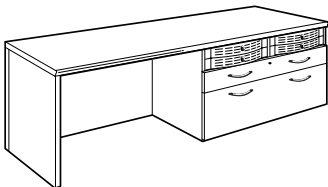

OCXL-2272-NR (Right-hand shown)

- Lateral file configurations: (2) lateral files with lock, open storage shelves/6" lateral file/ 12" lateral file with lock, or metal project drawers/6" lateral file/12" lateral file with lock.
- Full-height back panel with a continuous wireway cutout.
- Drawer pulls and project drawers are standard in black finish color only.
- Kneespace clearance: 28 1/8"(715mm) high x 20"(508mm) deep x 34 7/8"(885mm) wide.
- Credenza shipped unassembled. Storage unit shipped assembled.
- Drawer interior is steel.
- Credenzas ordered as left- or right-hand cannot be field reconfigured to the opposite orientation.

**To Order, Specify:**

- 1) Product number.  
–Specify lateral file drawer as **9th digit** in product number.  
**L** Lateral file  
**M** Shelf/shelf/box/file, add **\$150** list  
**N** Project drawer/project drawer/box/lateral file, add **\$648** list  
–Specify lateral storage orientation as **10th digit** in product number.  
**L** Left-handed storage  
**R** Right-handed storage
- 2) Wood finish color.
- 3) Plastic laminate finish color (if specified).

# Orlando by SMED

	Height	Depth	Width	Number	Wood Finish Group			
					1	2	3	4
<b>Credenza with Symmetrical Kneespace</b>	29 1/4"(745mm)	22"(559mm)	66"(1676mm)	OCSD-2266-JJ	\$1551	\$1633	\$1715	\$1960
	29 1/4"(745mm)	22"(559mm)	72"(1829mm)	OCSD-2272-JJ	\$1631	\$1717	\$1803	\$2060

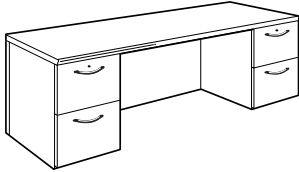

OCSD-2266-JJF  
OCSD-2272-JJF

- Pedestal configuration: (2) File/file with locks.
- Full-height back panel has a continuous wireway cutout.
- Drawer pulls are standard in black finish color only.
- Kneespace clearance:  
66"(1676mm) credenza - 28 1/8"(715mm) high x 20"(508mm) deep x 33 3/8"(846mm) wide.  
72"(1829mm) credenza - 28 1/8"(715mm) high x 20"(508mm) deep x 39 3/8"(999mm) wide.
- Credenza shipped unassembled. Storage unit shipped assembled.
- Drawer interior is steel.

**To Order, Specify:**

- 1) Product number.  
–Specify modesty panel as **11th digit** in product number.  
**F** Full modesty, add \$50 list  
**N** No modesty
- 2) Wood finish color.
- 3) Plastic laminate finish color (if specified).

	Height	Depth	Width	Number	\$1880	\$1979	\$2078	\$2375
<b>Door/Drawer Credenza</b>	29 1/4"(745mm)	22"(559mm)	72"(1829mm)	OCFM-2272-				

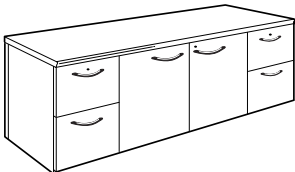

OCFM-2272-K

- Pedestal configuration: (2) File/file pedestals with locks and two-door center storage with lock option.
- Center storage includes one (1) adjustable shelf.
- Full-height back panel with continuous wireway cutout.
- Drawer pulls are standard in black finish color only.
- Credenza shipped unassembled. Pedestals and center storage shipped assembled.
- Drawer interior is steel.

**To Order, Specify:**

- 1) Product number.  
–Specify center storage lock as **9th digit** in product number.  
**K** Lock, add \$150 list  
**N** No lock
- 2) Wood finish color.
- 3) Plastic laminate finish color (if specified).

# Orlando by SMED

	Height	Depth	Width	Number	Wood Finish Group			
					1	2	3	4
<b>Four Door Vertical Storage Unit</b>	38 3/4"(980mm)	16 7/8"(429mm)	66"(1676mm)	OVF-3966- <input type="checkbox"/>	<b>\$1708</b>	<b>\$1798</b>	<b>\$1888</b>	<b>\$2158</b>
	38 3/4"(980mm)	16 7/8"(429mm)	72"(1829mm)	OVF-3972- <input type="checkbox"/>	<b>1809</b>	<b>1904</b>	<b>1999</b>	<b>2285</b>

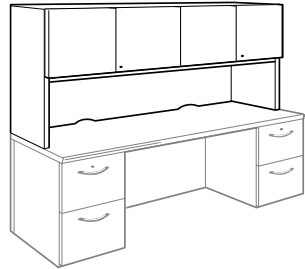

- Attaches to a credenza, flush-top desk, or return.
- 20 3/4"(527mm) clearance from credenza or desk top to underside of storage unit valence.
- Accepts separately-specified task lighting (see page 33), tackboard and grid (see page 34).
- Lower shelf construction is wood.
- Shipped assembled.

**To Order, Specify:**

- 1) Product number.  
 -Specify file lock as **8th digit** in product number.  
 **K** Lock, add **\$300** list  
 **N** No lock
- 2) Wood finish color.

OVF-3966-K  
OVF-3972-K



# Orlando by SMED

	Height	Depth	Width	Number	Wood Finish Group			
					1	2	3	4

**Vertical Storage Unit  
Open Center Storage**

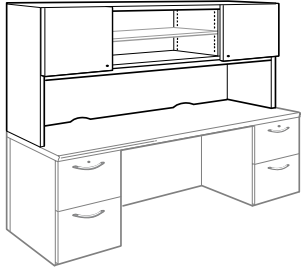

OVS-3972-K  
Class RA

38 3/4"(980mm)	16 7/8"(429mm)	72"(1829mm)	OVS-3972-	\$1678	\$1766	\$1854	\$2119
----------------	----------------	-------------	-----------	--------	--------	--------	--------

- Attaches to a credenza, flush-top desk, or return.
- 20 3/4"(527mm) clearance from credenza or desk top to underside of storage unit valence.
- Accepts separately-specified task lighting (see below), adjustable shelves, tackboard and grid (see page 34).
- Shipped assembled.
- Lower shelf construction is wood.

**To Order, Specify:**

- 1) Product number.  
-Specify file lock as **8th digit** in product number.  
**K** Lock, add \$300 list  
**N** No lock
- 2) Wood finish color.

**Two Door Vertical  
Storage Unit**

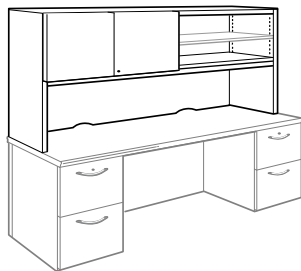

OVX-3972-KL (Left-hand shown)  
Class RA

38 3/4"(980mm)	16 7/8"(429mm)	72"(1829mm)	OVX-3972-	\$1678	\$1766	\$1854	\$2119
----------------	----------------	-------------	-----------	--------	--------	--------	--------

- Attaches to a credenza, flush-top desk, or return.
- 20 3/4"(527mm) clearance from credenza or desk top to underside of storage unit valence.
- Accepts separately-specified task lighting (see below), adjustable shelves, tackboard and grid (see page 34).
- Shipped assembled.
- Lower shelf construction is wood.

**To Order, Specify:**

- 1) Product number.  
-Specify file lock as **8th digit** in product number.  
**K** Lock, add \$150 list  
**N** No lock  
-Specify storage orientation as **9th digit** in product number.  
**L** Left-handed enclosed storage  
**R** Right-handed enclosed storage
- 2) Wood finish color.

**Fixed-Intensity Task  
Lighting (Wood Bottom  
Vertical Storage Unit)**

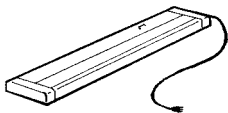

YHTL-0024-WT  
YHTL-0024-WTC  
Class RB

Height	Depth	Width	Description	Number	Price
1 1/2"(38mm)	6 7/8"(175mm)	24.3"(617mm)		YHTL-0024-WT	\$167
		36.3"(922mm)		YHTL-0036-WT	187
		48.3"(1227mm)		YHTL-0048-WT	195
1 1/2"(38mm)	6 7/8"(175mm)	24.3"(617mm)	Chicago task light	YHTL-0024-WTC	\$220
		36.3"(922mm)	Chicago task light	YHTL-0036-WTC	252
		48.3"(1227mm)	Chicago task light	YHTL-0048-WTC	260

- Provides task lighting beneath overhead and vertical storage units.
- Task light width must be less than width of storage unit.
- Includes (1) set of mounting screws, lens, and cord to attach to wood bottom shelf of corner vertical storage unit.
- Nine-foot cord is factory-installed on right side; may be field-installed on left side.
- Units shipped with T-8 octic tri-phosphoric lamp with a 3500K color temperature.
- **For use with 120 volt 60 hertz electrical systems only.**
- Recommended for use with Vertical Storage Unit Open Center Storage and Two Door Vertical Storage Unit.

**To Order, Specify:**

- 1) Product number.  
(No finish specification required.)

**Task Light Application Matrix**

Overhead Storage	24.3" Task Light	36.3" Task Light	48.3" Task Light
66"	2	1	1
72"	2	1	1

For full length lighting, (2) 24.3" wide lights will mount under overhead storage units 54" wide and above. Additional combinations not exceeding the width of the overhead could be used.

# Orlando by SMED

	Height	Depth	Width	Description	Number	Price
--	--------	-------	-------	-------------	--------	-------

### Adjustable Shelf

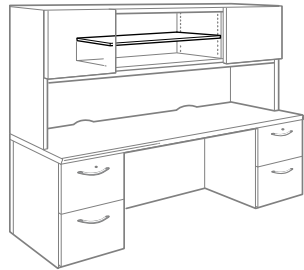

3/4"(19mm)	14 7/8"(378mm)	34 1/2"(876mm)	For 72" open cabinet	OSOL-35	\$117
------------	----------------	----------------	----------------------	---------	-------

- Mounts in pre-assigned adjustment holes.
- Mounting hardware included.
- Can only be used with Vertical Storage Unit Open Center Storage and Two Door Vertical Storage Unit.

#### To Order, Specify:

- 1) Product number.
- 2) Wood finish color.

OSOL  
Class RA

### Tackboard

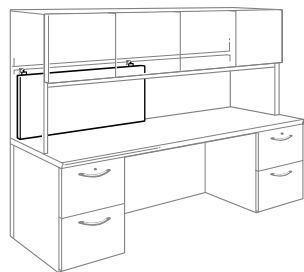

Height	Depth	Width	Description	Number	Fabric Grade		
					A	B	C
18 1/2"(472mm)	1 1/4"(32mm)	32"(816mm)	For 66" storage unit	OATB-2032	\$117	\$124	\$139
		35"(892mm)	For 72" storage unit	OATB-2035	123	130	145

- Mounts on a vertical storage unit back panel.
- Each vertical storage unit will accept a maximum of two (2) tackboards.
- Price includes one (1) tackboard and mounting hardware.
- COM yardage: OATB-2032 1 yard  
OATB-2035 1.5 yards

#### To Order, Specify:

- 1) Product number.
- 2) Fabric surface and color.

OATB  
Class RA

### Grid

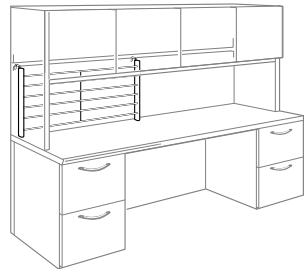

Height	Depth	Width	Description	Number	Price
20 1/2"(521mm)	1 1/4"(32mm)	31 7/8"(810mm)	For 66" storage unit	OAHG-2032	\$134
		34 7/8"(886mm)	For 72" storage unit	OAHG-2035	134

- Mounts on a vertical storage unit back panel.
- Each vertical storage unit will accept a maximum of two (2) grids.
- Standard in charcoal finish color only.
- Price includes one (1) grid and mounting hardware.

#### To Order, Specify:

- 1) Product number.  
(No finish specification required.)

OAHG  
Class RA

### Mailbox

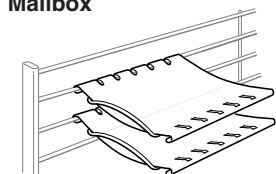

10 3/4"(273mm)	12 1/2"(318mm)	Grid mounted	HGMB-0002	\$90
		Freestanding	HFMB-0002	90

- Provides convenient storage for paper documents.
- Available in grid mount or freestanding option.
- Price includes two (2) trays and support hardware.
- Shipped unassembled.

#### To Order, Specify:

- 1) Product number.
- 2) Trim color.

HGMB-0002

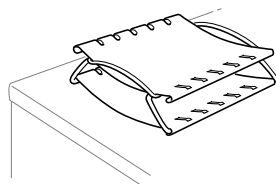

HFMB-0002  
Class BA

# Orlando by SMED

	Height	Depth	Width	Number	Price
--	--------	-------	-------	--------	-------

**Reference Tray**

13"(330mm) 10 3/4"(273mm)

HGRT-0001 \$ 90

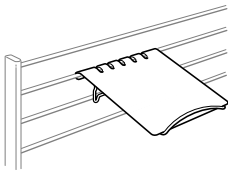

HGRT-0001

- Provides angled tray for holding open documents.
- Requires the support of a grid.
- Price includes one (1) tray and mounting hardware.
- Shipped unassembled.

**To Order, Specify:**

- 1) Product number.
- 2) Trim color.

**Diskette Bin**

3 1/2"(89mm) 2 1/2"(64mm) 6"(152mm)

HGDB-0004 \$102

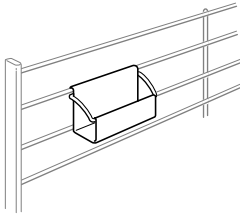

HGDB-0004

- Provides open storage for up to (23) 5 1/4" diskettes or (10) 3 1/2" diskettes.
- Mounts on a grid or can be freestanding on desk top.
- Price includes four (4) diskette bins.

**To Order, Specify:**

- 1) Product number.
- 2) Trim color.

**Tackstrip**

3 1/2"(89mm) 1/4"(6mm) 24"(610mm)  
30"(762mm)

HGTS-0024 \$228  
HGTS-0030 286

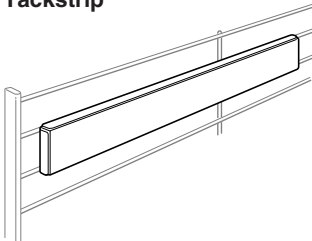

HGTS

- Provides mini-tackable surface.
- Mounts between two horizontal grid members.
- Price includes four (4) tackstrips.

**To Order, Specify:**

- 1) Product number.
- 2) Bracket trim color.
- 3) Cork surface color.  
TM-073 Medium Gray  
TM-076 Light Tan

**Multi-Purpose Storage Bins**

3 1/2"(89mm) 3"(76mm) 4"(102mm)  
8"(203mm)

HGBN-0004 \$ 97  
HGBN-0008 122

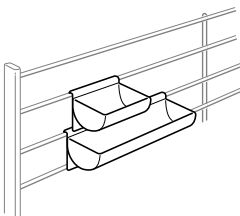

HGBN  
(Both sizes shown)

- Provides open storage for miscellaneous office supplies.
- Requires the support of a grid.
- Price includes four (4) storage bins of **one size**.

**To Order, Specify:**

- 1) Product number.
- 2) Trim color.

# Orlando by SMED

	Height	Depth	Width	Number	Wood Finish Group			
					1	2	3	4

**Two-High Lateral File**

29 1/4"(745mm)	22"(559mm)	36"(914mm)	OSLF-2936	\$1122	\$1181	\$1240	\$1417
----------------	------------	------------	-----------	--------	--------	--------	--------

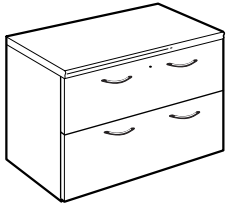

- Two drawers with one front-mounted lock.
- Letter or legal lateral filing.
- Front-to-back filing bars provided.
- Anti-tilt mechanism.
- Drawer pulls are standard in black finish color only.
- Drawer pulls are factory installed.
- Shipped assembled.

**To Order, Specify:**

- 1) Product number.
- 2) Wood finish color.
- 3) Plastic laminate finish color (if specified).

OSLF-2936

**Lateral File Mounted Bookcase**

38 3/4"(980mm)	16"(405mm)	36"(914mm)	OSBF-3936	\$817	\$860	\$903	\$1032
----------------	------------	------------	-----------	-------	-------	-------	--------

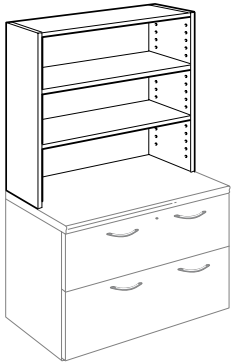

- Includes two (2) adjustable shelves.
- Attaches to a two-high lateral file.
- Attachment hardware included.
- Shipped assembled.

**To Order, Specify:**

- 1) Product number.
- 2) Wood finish color.

OSBF-3936

# Orlando by SMED

	Height	Depth	Width	Number	Wood Finish Group			
					1	2	3	4

**Three-High Bookcase**

38 7/8"(988mm)	16"(405mm)	36"(914mm)	OSBC-3936	\$868	\$914	\$960	\$1097
----------------	------------	------------	-----------	-------	-------	-------	--------



- Includes two (2) adjustable shelves.
- Shipped assembled.

**To Order, Specify:**

- 1) Product number.
- 2) Wood finish color.

OSBC-3936

**Five-High Bookcase**

68"(1725mm)	16"(405mm)	36"(914mm)	OSBC-6836	\$1104	\$1162	\$1220	\$1394
-------------	------------	------------	-----------	--------	--------	--------	--------

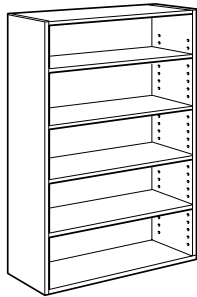

- Includes four (4) adjustable shelves.
- Shipped assembled.

**To Order, Specify:**

- 1) Product number.
- 2) Wood finish color.

OSBC-6836

# Orlando by SMED

	Height	Depth	Width	Number	Wood Finish Group				
					1	2	3	4	
<b>Wardrobe/Storage Cabinet</b>	68"(1725mm)	22"(559mm)	24"(610mm)	OSWC-6824-	■ ■	\$2363	\$2487	\$2611	\$2984

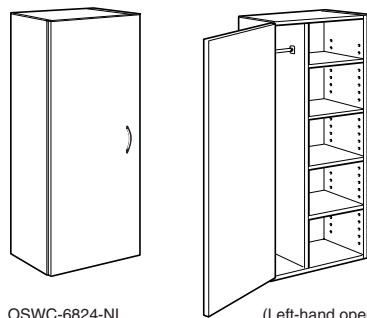

OSWC-6824-NL  
(Left-hand closed view)

(Left-hand open view)

- Storage configuration: Full-height storage with four (4) wood adjustable shelves and full-height wardrobe storage.
- Door pull is standard in black finish color only.
- Shipped assembled. Door pull is factory installed.

**To Order, Specify:**

- 1) Product number.
  - Specify door lock as **9th digit** in product number.
  - K** Lock, add \$150 list
  - N** No lock
  - Specify door swing orientation as **10th digit** in product number.
  - L** Left-handed
  - R** Right-handed
- 2) Wood finish color.

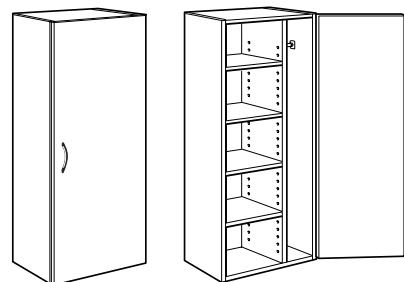

OSWC-6824-NR  
(Right-hand closed view)

(Right-hand open view)

<b>Wardrobe/File Storage Cabinet</b>	68"(1725mm)	22"(559mm)	24"(610mm)	OSWF-6824-	■ ■	\$2650	\$2790	\$2930	\$3348
--------------------------------------	-------------	------------	------------	------------	-----	--------	--------	--------	--------

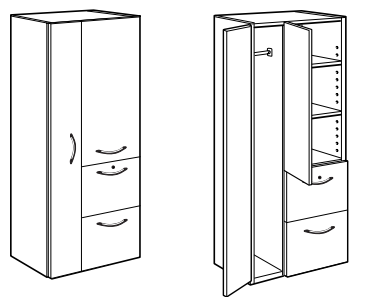

OSWF-6824-NL  
(Left-hand closed view)

(Left-hand open view)

- Standard storage configuration: Lower file/file pedestal with lock, upper three-high storage with two (2) wood adjustable shelves and full-height wardrobe storage.
- Drawer/door pulls are standard in black finish color only.
- Shipped assembled. Door/drawer pulls are factory installed.

**To Order, Specify:**

- 1) Product number.
  - Specify door locks as **9th digit** in product number.
  - K** Lock, add \$300 list
  - N** No lock
  - Specify door swing orientation as **10th digit** in product number.
  - L** Left-handed
  - R** Right-handed
- 2) Wood finish color.

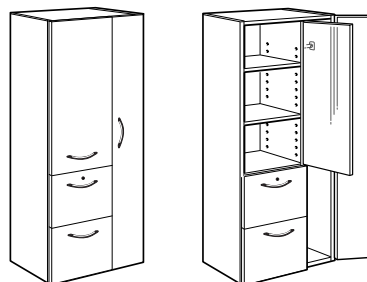

OSWF-6824-NR  
(Right-hand closed view)

(Right-hand open view)

# Orlando by SMED

	Height	Depth	Width	Number	Wood Finish Group			
					1	2	3	4

<b>“Putter” Mobile Pedestal</b>	27 1/2”(701mm)	22”(559mm)	16 1/2”(415mm)	OPMQ-2216	\$1068	\$1124	\$1180	\$1349
---------------------------------	----------------	------------	----------------	-----------	--------	--------	--------	--------



- Drawer configuration: Open storage shelf/box/file with front-mounted lock.
- Casters are standard in charcoal finish color only.
- Shipped assembled. Drawer pulls are factory installed.

**To Order, Specify:**

- 1) Product number.
- 2) Wood finish color.

OPMQ-2216

<b>“Tugger” Mobile Computer Table</b>	29 1/4”(745mm)	27”(686mm)	36”(914mm)	OBCT-2736	\$811	\$854	\$897	\$1025
---------------------------------------	----------------	------------	------------	-----------	-------	-------	-------	--------

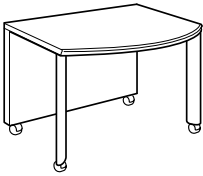

- Includes four (4) casters; two (2) locking, two (2) non-locking.
- Support legs and casters are standard in charcoal finish color only.
- Kneespace clearance: 28 1/8”(715mm) high x 26 1/2” (673mm) wide.
- Shipped unassembled.

**To Order, Specify:**

- 1) Product number.
- 2) Wood finish color.
- 3) Plastic laminate finish color (if specified).

OBCT-2736

<b>“Scooch” Mobile Laptop Caddy</b>	29 1/4”(745mm)	24”(610mm)	30”(762mm)	OBLC-2430	\$832	\$876	\$920	\$1051
-------------------------------------	----------------	------------	------------	-----------	-------	-------	-------	--------



- Includes three (3) casters; one (1) locking, two (2) non-locking.
- Support leg and casters are standard in charcoal finish color only.
- Kneespace clearance: 24”(610mm) high x 22 1/2” (572mm) wide.
- Shipped unassembled.

**To Order, Specify:**

- 1) Product number.
- 2) Wood finish color.
- 3) Plastic laminate finish color (if specified).

OBLC-2430

# Orlando by SMED

	Height	Diameter	Flat Side	Number	Wood Finish Group			
					1	2	3	4
<b>“Bumper” Docking Table</b>	29 1/4”(745mm)	42”(1067mm)	30”(762mm)	OBCD-4230- <input type="checkbox"/>	\$1205	\$1268	\$1331	\$1522
		48”(1219mm)	36”(914mm)	OBCD-4836- <input type="checkbox"/>	1325	1395	1465	1674

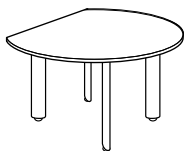

OBCD-4230-G  
OBCD-4836-G

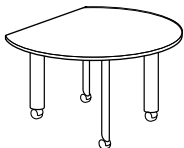

OBCD-4230-C  
OBCD-4836-C

- Available with four (4) glides or two (2) locking and two (2) non-locking casters.
- Table legs, glides and casters standard in charcoal finish color only.

**To Order, Specify:**

- 1) Product number.  
–Specify leg option as **9th digit** in product number.  
 **C** Casters, add \$60 list  
 **G** Glides
- 2) Wood finish color.
- 3) Plastic laminate finish color (if specified).

**Round Table**

29 1/4”(745mm)	42”(1067mm)	OBCR-42- <input type="checkbox"/>	\$1252	1318	1384	1582
	48”(1219mm)	OBCR-48- <input type="checkbox"/>	1325	1395	1465	1674

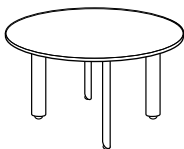

OBCR-42-G  
OBCR-48-G

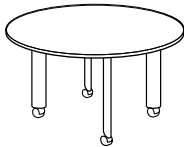

OBCR-42-C  
OBCR-48-C

- Available with four (4) glides or two (2) locking and two (2) non-locking casters.
- Table legs, glides and casters standard in charcoal finish color only.

**To Order, Specify:**

- 1) Product number.  
–Specify leg option as **7th digit** in product number.  
 **C** Casters, add \$60 list  
 **G** Glides
- 2) Wood finish color.
- 3) Plastic laminate finish color (if specified).

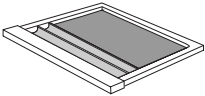
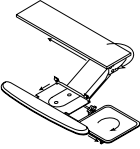
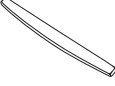
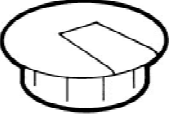

# Orlando by SMED

	Height	Depth	Width	Number	Price
<b>Center Drawer</b>  YRCD-1 Class RB	1"(25mm)	18"(457mm)	23"(584mm)	YRCD-1	\$198
	<ul style="list-style-type: none"> <li>• Non-locking drawer.</li> <li>• Requires field installation.</li> </ul>		<b>To Order, Specify:</b> 1) Product number. 2) Wood finish color.		
<b>Adjustable Keyboard Pad</b>  L-AKP-3 Class RA	3 1/2"(89mm)	5 3/4"-9"(146mm-229mm)	17"-22"(432mm-559mm)	L-AKP-3	\$450
	<ul style="list-style-type: none"> <li>• Includes adjustable keyboard pad and palm rest.</li> <li>• Spring assisted mechanism tilts, raises, lowers and has dual swivel complete with adjustable palm rest.</li> <li>• Mouse pad swivels, tilts, and is interchangeable between right and left hand applications.</li> </ul>		<b>To Order, Specify:</b> 1) Product number. (No finish specification required.)		
<b>Wrist Support</b>  L-LPR-2 Class RA	1"(25mm)	2 1/2"(64mm)	27 3/4"(705mm)	L-LPR-2	\$ 89
	<ul style="list-style-type: none"> <li>• Gel interior.</li> <li>• Standard in black finish color only.</li> <li>• Covers keyboard and mouse area.</li> </ul>		<b>To Order, Specify:</b> 1) Product number. (No finish specification required.)		
<b>Grommet</b>  YSG-1 Class RB	1"(25mm)	3"(76mm)	3"(76mm)	YSG-1	\$ 11
	<ul style="list-style-type: none"> <li>• Requires field installation.</li> <li>• Standard in black finish color only.</li> </ul>		<b>To Order, Specify:</b> 1) Product number. (No finish specification required.)		

# Orlando by SMED

	Height	Depth	Width	Number	Price
<b>Wire Management Arc</b>	12"(305mm)	4"(102mm)	66"(1676mm)	OWM-6612	\$290
			72"(1829mm)	OWM-7212	306

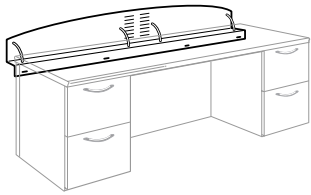

- Horizontal metal trough provides cable storage behind casegood.
- Mounts on the back side of a 66"(1676mm) or 72"(1829mm) wide return or credenza.
- Price includes mounting screws.
- Standard in charcoal finish color only.

**To Order, Specify:**

- 1) Product number.  
(No finish specification required.)

OWM-6612  
OWM-7212  
Class RA

<b>Wire Channel</b>			36"(914mm)	L-WMT	\$37
---------------------	--	--	------------	-------	------

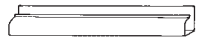

- Specify for use with desks and kneespace credenzas.

**To Order, Specify:**

- 1) Product number.  
(No finish specification required.)

L-WMT  
Class RA

<b>Power Domes</b>	Description	Number	Price
 OLTD-2 Class RA	Two (2) power outlets and two (2) plates for data connections	OLTD-2	\$144
	Four (4) power outlets	OLTD-4	158

- Provides power and communication access at desk top height.
- Mounts into a field-cut 3"(76mm) diameter hole.
- Standard in black finish color only.
- OLTD-2 accepts category 3 connection hardware.
- OLTD-2 includes one (1) 72"(1829mm) long power cord and 15-amp plug. OLTD-4 includes two (2) 72"(1829mm) long power cords and 15-amp plugs.
- Requires field installation.

**To Order, Specify:**

- 1) Product number.  
(No finish specification required.)

<b>Lateral File Accessories</b>	15" deep lateral file front to back hanging bar	YALF-15	\$15
	36" wide lateral file side to side steel hanging bar	TALS-36	23

- Black trim color.

**To Order, Specify:**

- 1) Product number  
(No finish specification required.)

YALF-15  
Class RB

# Tripoli by SMED

<b>Product Offering</b>	The Tripoli product offering consists of the following:											
	Table Desks	Desk Extensions	Pedestals	Presentation Board								
	Single Pedestal Desks	Returns and Bridges	Mobile Pedestals	Conference Tables								
	Double Pedestal Desks	Vertical Storage Units	Lateral Files	Conference Bases								
	L-Desks	Overhead Cabinets	Bookcases	Occasional Tables								
	U-Stations	Reception Desks	Wardrobe/Storage Cabinets									
	Credenzas	Corner Units	Conference Buffet									
	Desk and Credenza Shells	CRT Tables	Conference Caddy									
<b>Construction Features</b>	<p>Tripoli casegoods tops are constructed of a 1 1/2"(38mm)-thick, particle board core faced with a variety of fine veneer surfaces with the following solid wood edge options:</p> <ul style="list-style-type: none"> <li>-Square detail</li> <li>-Bevel detail</li> <li>-Chamfer detail</li> <li>-Radius detail</li> </ul> <p>Edge detail applies only to the desk top approach and user's edges, and the top user's edge of all other desk-height casegoods.</p> <p>All joints are cam and doweled, to assure true panel alignment and strength of joinery. Tops are fastened to cases with KD fasteners.</p>											
<b>Drawer Front Construction</b>	<p>Pedestal box and file drawers: Medium-density fiber board core with wood veneer surface.</p> <p>Lateral file drawers: Particle board core. Finger pulls formed using inlaid wood solids.</p>											
<b>Drawer Box Construction</b>	<p>Modular/Steel: 6" letter box drawers are modular plastic with spacers for dividers. 6" legal box drawers are steel. 12" drawers are steel.</p> <p>Wood: Wood veneered, doweled and glued corner joints.</p>											
<b>Drawer Slides</b>	<p>Ball-bearing construction for smooth and quiet action. Box drawers utilize 75-pound full-extension slides. File drawers utilize 100-pound full-extension slides. Lateral file drawers utilize 150-pound full-extension slides.</p>											
<b>Casters</b>	Hard wheel caster, 2 3/8" diameter.											
<b>Table Leg Glides</b>	Metal glide; adjustable with a 1 1/2" range.											
<b>Cabinet Glides</b>	Metal 3/8" glide with hex head top and bottom for easy adjustment; 1 1/2" range.											
<b>Wire Management</b>	<p>All Tripoli casegoods have built-in wireway cutouts in the upper corners of the modesty panel. Vertical storage units have built-in cutouts in the lower corners of the back panel. CRT carts have a continuous wireway along the top of the modesty panel and a wireway cutout at the center of the lower shelf.</p> <p>Grommets may be specified on all desks, bridges, credenzas and CRT tables. Black finish only.</p> <p>Wire managers may be specified to route cables horizontally or vertically between pedestals. The wire manager is a 36"(914mm) black plastic extrusion, cut on-site, and attached to the modesty panel or underside of the casegood top with double-faced tape. Attachment tape is included for installation.</p>											
<b>Accessories</b>	<p>The following accessories require field installation:</p> <table border="0"> <tr> <td>Adjustable Keyboard Pad</td> <td>Convenience Outlet Strip</td> </tr> <tr> <td>Center Pencil Drawers</td> <td>Tasklights</td> </tr> <tr> <td>Keyboard Pullout Tray</td> <td>Tackboards</td> </tr> <tr> <td>Wire Manager</td> <td>Shelf</td> </tr> </table>				Adjustable Keyboard Pad	Convenience Outlet Strip	Center Pencil Drawers	Tasklights	Keyboard Pullout Tray	Tackboards	Wire Manager	Shelf
Adjustable Keyboard Pad	Convenience Outlet Strip											
Center Pencil Drawers	Tasklights											
Keyboard Pullout Tray	Tackboards											
Wire Manager	Shelf											

# Tripoli by SMED

**Veneer** All exposed veneers are plain-sliced and book-matched. Drawer fronts, per pedestal, are matched in sets for consistent grain and color.

**Finishing** 2-step finishing process sealed with conversion varnish.

Because of the natural properties of wood, variations of grain pattern and finish color can be expected. Materials used in the manufacturing of products are carefully selected to promote consistent and acceptable color. Wood is susceptible to color change from long-term exposure to sunlight.

To keep your wood writing surfaces looking beautiful for the life of the product, it is highly recommended that a blotter pad, glass, or plexiglass surface be used under writing instruments.

Tripoli casegoods are available with 3 wood grain laminates for use on tops and writing surfaces. Laminates are recommended for severe use applications.

**Edge Details**

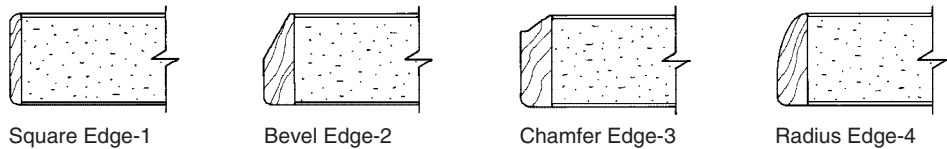

**General Guidelines for Product Specification**

Tripoli product specification numbers are based on an alpha-numeric logic that identifies a product by product line, size and certain characteristics.

For instance, a product number that reads **TRDD-3066-4SN** identifies the product as a Tripoli full height pedestal desk, 30”(762mm) deep and 66”(1676mm) wide, with the Radius edge detail.

The alpha-numeric logic for a Tripoli full-height pedestal desk with Cherry veneer and Medium Cherry finish color is shown below:

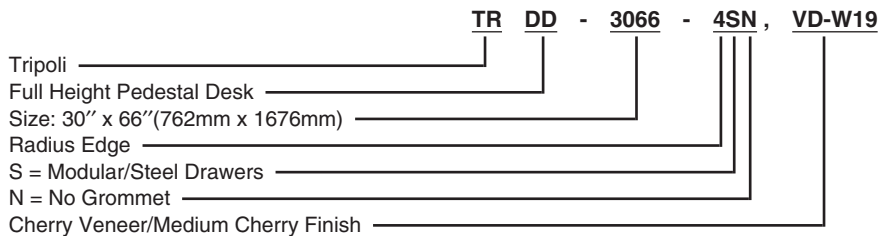

There are exceptions to this logic; therefore, always refer to the price charts for product numbers rather than attempting to construct them. Product number modification instructions for additional options appear in footnoted copy for each applicable product.

Beyond the printed product number, wood finish color and optional surface finish codes are required to complete an order specification. To communicate your order clearly, list the product number and finish codes in the sequence outlined on each price page.

**Tag for Ordering**

Tripoli is manufactured so that every piece in an office can be constructed from the same wood flitch. This provides superior color and grain matching. In order to meet these high standards, Haworth requires that all items in the order be tagged with an individual office location. Items will be manufactured, labeled and shipped so that installers can easily identify items by office.

**Finishes and Fabrics**

A complete listing of finishes and fabrics for Tripoli casegoods can be found on pages 207-211.

**Lock Programs**

Desks, returns and credenzas with pedestals, wardrobe/storage cabinets, and lateral files each feature one or more locks. Vertical storage units are available with or without locks. Tagged offices will be keyed alike.

All locks will have a bright zinc finish regardless of veneer type or wood finish color.

Refer to the current Lock Programs Specification Guidelines Price List for master keying. Contact the Haworth Order Services Inquiry Center for more information.

## Pedestal Files — 19" (481mm) Width

- Applies to pedestals on returns, credenzas, and storage units, and pedestals on 72"-wide single- and double-pedestal desks.
- Adjustable bars available in service parts to accommodate front/back letter filing.

### 20" DEEP PEDESTALS – RETURNS, CREDENZAS, AND STORAGE UNITS

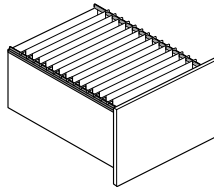

Legal Filing  
15½" (392mm)

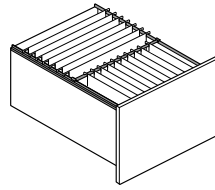

Legal/A4 and Letter Filing  
18" (458mm)

### 26" DEEP PEDESTALS – 72"-WIDE DESKS

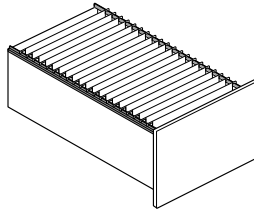

Legal/A4 Filing  
21" (532mm)

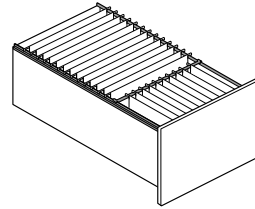

Legal/A4 and Letter Filing  
23½" (598mm)

## Pedestal Files — 16 3/8" (415mm) Width

- Applies to separately-specified pedestals and mobile pedestal/return, and pedestals on 66"-wide single- and double-pedestal desks.

### 20" DEEP PEDESTALS – SEPARATELY SPECIFIED PEDESTALS AND MOBILE PEDESTAL/RETURN

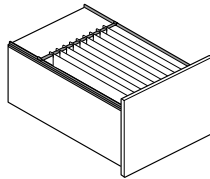

Legal/A4 Filing  
12 7/8" (326mm)

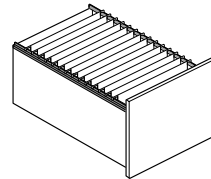

Letter/A4 Filing  
15 5/8" (392mm)

### 26" DEEP PEDESTALS – 66"-WIDE DESKS

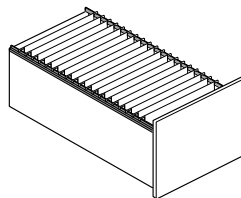

Letter/A4 Filing  
21" (532mm)

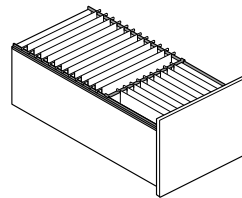

Legal/A4 and Letter Filing  
18 5/8" (466mm)

## Lateral Files — 30" (762mm), 31" (787mm) Width

- Applies to separately-specified stationary lateral files, and lateral files on returns and credenzas.
- Adjustable bars are included to accommodate side/side letter filing.

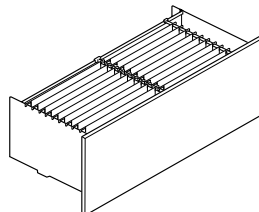

Letter/A4 Filing  
30 3/4" (770mm)

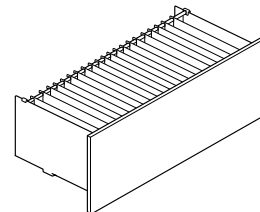

Letter, Legal, and A4 Filing  
26 5/8" (682mm)

## Lateral Files — 36" (914mm), 37" (940mm) Width

- Applies to separately-specified stationary lateral files, and lateral files on returns and credenzas.
- Adjustable bars are included to accommodate side/side letter filing.

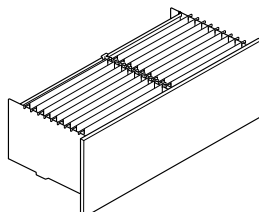

Legal Filing  
30 3/4" (770mm)

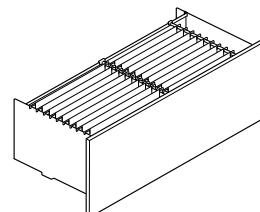

Letter/A4 Filing  
30 3/4" (770mm)

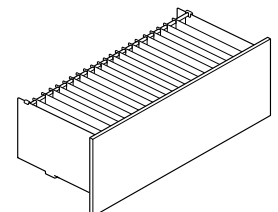

Letter, Legal, and A4 Filing  
32 3/4" (834mm)

# Filing Capacities for Wood Pedestal Files/Lateral Files; Drawer Dimensions

## Pedestal Files — 19" (481mm) Width

- Applies to pedestals on returns, credenzas, and storage units, and pedestals on 72"-wide single- and double-pedestal desks.
- Adjustable bars available in service parts to accommodate front/back letter filing.

### 20" DEEP PEDESTALS – RETURNS, CREDENZAS, AND STORAGE UNITS

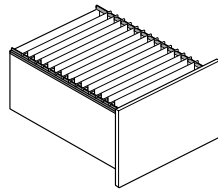

Legal Filing  
15 1/2" (392mm)

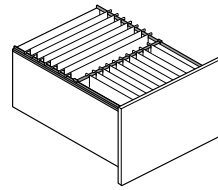

Legal/A4 and Letter Filing  
18" (458mm)

### 26" DEEP PEDESTALS – 72"-WIDE DESKS

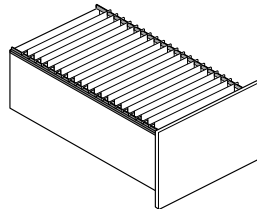

Legal/A4 Filing  
21" (532mm)

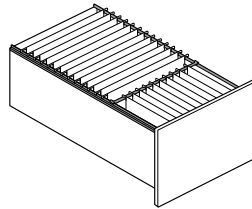

Legal/A4 and Letter Filing  
23 1/2" (598mm)

## Pedestal Files — 16 3/8" (415mm) Width

- Applies to separately-specified pedestals and mobile pedestal/return, and pedestals on 66"-wide single- and double-pedestal desks.

### 20" DEEP PEDESTALS – SEPARATELY SPECIFIED PEDESTALS AND MOBILE PEDESTAL/RETURN

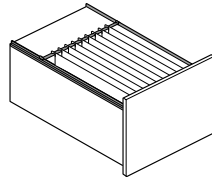

Legal/A4 Filing  
12 7/8" (326mm)

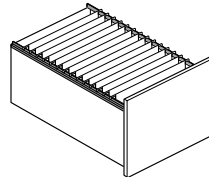

Letter/A4 Filing  
15 5/8" (392mm)

### 26" DEEP PEDESTALS – 66"-WIDE DESKS

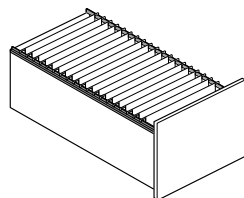

Letter/A4 Filing  
21" (532mm)

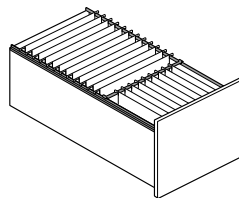

Legal/A4 and Letter Filing  
18 3/8" (466mm)

## Lateral Files — 30" (762mm), 31" (787mm) Width

- Applies to separately-specified stationary lateral files, and lateral files on returns and credenzas.
- Adjustable bars are included to accommodate side/side letter filing.

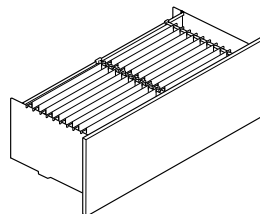

Letter/A4 Filing  
30 1/4" (770mm)

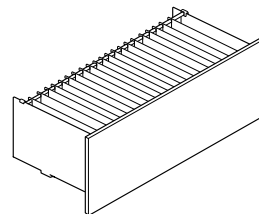

Letter, Legal, and A4 Filing  
25 5/8" (657mm)

## Lateral Files — 36" (914mm), 37" (940mm) Width

- Applies to separately-specified stationary lateral files, and lateral files on returns and credenzas.
- Adjustable bars are included to accommodate side/side letter filing.

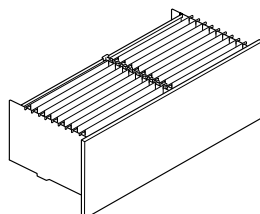

Legal Filing  
30 1/4" (770mm)

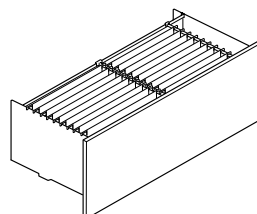

Letter/A4 Filing  
30 1/4" (770mm)

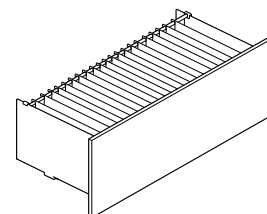

Letter, Legal, and A4 Filing  
31 5/8" (809mm)

# Tripoli by SMED

	Height	Depth	Width	Number	Wood Finish Group			
					1	2	3	4
<b>Table Desk</b>	29 1/2"(753mm)	36"(914mm)	72"(1829mm)	TRDT-3672- <input type="checkbox"/>	<b>\$1622</b>	<b>\$1707</b>	<b>\$1792</b>	<b>\$2048</b>

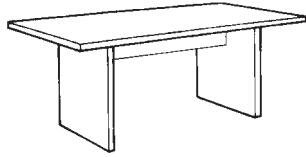

TRDT-3672-1

- Wood bases with adjustable glides, 24"(610mm) wide.
- Rectangular top (1 1/2"(38mm) thick).
- Table desk top available with wood veneer or plastic laminate.
- Accommodates separately-specified center pencil drawer, see page 78.
- Top and bases shipped unassembled.
- Edge detail on user and visitor sides.

**To Order, Specify:**

- 1) Product number.  
 -Specify edge detail as **9th digit** in product number.
  - 1 Square edge
  - 2 Bevel edge
  - 3 Chamfer edge
  - 4 Radius edge
- 2) Wood finish color.
- 3) Plastic laminate finish color (if specified).

# Tripoli by SMED

	Height	Depth	Width	Number	Wood Finish Group			
					1	2	3	4
<b>Single Pedestal Desk with Full-Height Pedestal</b>	29 1/2"(753mm)	30"(762mm)	60"(1524mm)	TDSF-3060- [ ] [ ] [ ]	\$1663	\$1751	\$1839	\$2101
			66"(1676mm)	TDSF-3066- [ ] [ ] [ ]	1732	1823	1914	2188
		36"(914mm)	72"(1829mm)	TDSF-3672- [ ] [ ] [ ]	1955	2058	2161	2470

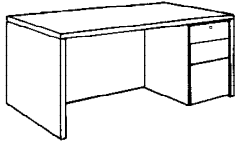

TDSF-1SN  
(Right shown)

- Pedestal configuration: Box/box/file with one lock.
- Recessed full-height modesty panel. TDSF-3060 and TDSF-3066 desks with 5 1/2"(140mm) recess. TDSF-3672 desk with 11 1/2"(292mm) recess.
- Desk top available with wood veneer or plastic laminate.
- Accommodates separately-specified center pencil drawer and wire manager, see pages 78-79.
- Legal size pedestal standard for 72"(1829mm) width.
- Letter size pedestal standard for 60"(1524mm) and 66"(1676mm) width.
- Edge detail on user and visitor sides.
- Right or left pedestal orientation determined at time of assembly.
- Top, end panels, and modesty shipped unassembled.
- Standard price includes modular/steel drawers.

**To Order, Specify:**

- 1) Product number.  
 -Specify edge detail as **9th digit** in product number.
  - 1** Square edge
  - 2** Bevel edge
  - 3** Chamfer edge
  - 4** Radius edge
 -Specify interior drawer construction as **10th digit** in product number.
  - S** Modular/Steel
  - W** Wood, add \$225 list.
 -Specify grommet option as **11th digit** in product number.
  - V** Left, add \$83 list.
  - Z** Right, add \$83 list.
  - J** Left and Right, add \$166 list.
  - N** No grommet.
- 2) Wood finish color.
- 3) Plastic laminate finish color (if specified).

<b>Single Pedestal Desk with Bow Front Full-Height Pedestal</b>	29 1/2"(753mm)	36"(914mm)	72"(1829mm)	TDSB-3672- [ ] [ ] [ ]	\$2217	\$2334	\$2451	\$2801
---	----------------	------------	-------------	------------------------	--------	--------	--------	--------

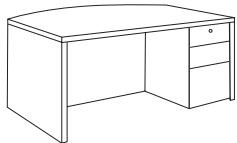

TDSB-1SN  
(Right shown)

- Pedestal configuration: Box/box/file with one lock.
- Recessed full-height modesty panel. TDSB-3672 desk with 11 1/2"(292mm) modesty recess on the sides, 17 1/2"(445mm) in center of bow front.
- Desk top available with wood veneer or plastic laminate.
- Accommodates separately-specified center pencil drawer and wire manager, see pages 78-79.
- Legal size pedestal standard for 72"(1829mm) width.
- Edge detail on user and visitor sides.
- Right or left pedestal orientation determined at time of assembly.
- Tops, end panels and modesty shipped unassembled.
- Standard price includes modular/steel drawers.

**To Order, Specify:**

- 1) Product number.  
 -Specify edge detail as **9th digit** in product number.
  - 1** Square edge
  - 2** Bevel edge
  - 3** Chamfer edge
  - 4** Radius edge
 -Specify interior drawer construction as **10th digit** in product number.
  - S** Modular/Steel
  - W** Wood, add \$225 list.
 -Specify grommet option as **11th digit** in product number.
  - V** Left, add \$83 list.
  - Z** Right, add \$83 list.
  - J** Left and Right, add \$166 list.
  - N** No grommet.
- 2) Wood finish color.
- 3) Plastic laminate finish color (if specified).

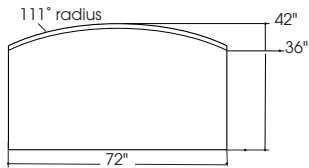



# Tripoli by SMED

	Height	Depth	Width	Number	Wood Finish Group			
					1	2	3	4
<b>Double Pedestal Desk with Full-Height Pedestals</b>	29 1/2"(753mm)	30"(762mm)	60"(1524mm)	TRDD-3060- <input type="checkbox"/> <input type="checkbox"/> <input type="checkbox"/>	\$1925	\$2026	\$2127	\$2431
			66"(1676mm)	TRDD-3066- <input type="checkbox"/> <input type="checkbox"/> <input type="checkbox"/>	1994	2099	2204	2519
		36"(914mm)	72"(1829mm)	TRDD-3672- <input type="checkbox"/> <input type="checkbox"/> <input type="checkbox"/>	2260	2379	2498	2855

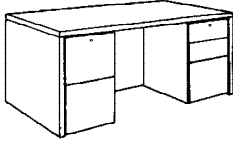

TRDD-1SN

- Pedestal configuration:  
Left; file/file with one lock.  
Right; box/box/file with one lock.
- Recessed full-height modesty panel.  
TRDD-3060 and TRDD-3066 desks with 5 1/2"(140mm) recess.  
TRDD-3672 desk with 11 1/2"(292mm) recess.
- Desk top available with wood veneer or plastic laminate.
- Accommodates separately-specified center pencil drawer and wire manager, see pages 78-79.
- Legal size pedestal standard for 72"(1829mm) width.
- Letter size pedestal standard for 60"(1524mm) and 66"(1676mm) width.
- Edge detail on user and visitor sides.
- Top, end panels, and modesty shipped unassembled.
- Standard price includes modular/steel drawers.

**To Order, Specify:**

- 1) Product number.  
–Specify edge detail as **9th digit** in product number.
  - 1 Square edge
  - 2 Bevel edge
  - 3 Chamfer edge
  - 4 Radius edge
 –Specify interior drawer construction as **10th digit** in product number.
  - S Modular/Steel.
  - W Wood, add \$450 list.
 –Specify grommet option as **11th digit** in product number.
  - V Left, add \$83 list.
  - Z Right, add \$83 list.
  - J Left and Right, add \$166 list.
  - N No grommet.
- 2) Wood finish color.
- 3) Plastic laminate finish color (if specified).

<b>Double Pedestal Desk with Bow Front Full-Height Pedestals</b>	29 1/2"(753mm)	36"(914mm)	72"(1829mm)	TDDB-3672- <input type="checkbox"/> <input type="checkbox"/> <input type="checkbox"/>	\$2522	\$2655	\$2788	\$3186
--	----------------	------------	-------------	---	--------	--------	--------	--------

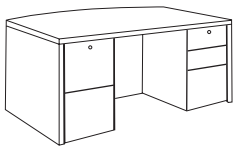

TDDB-1SN

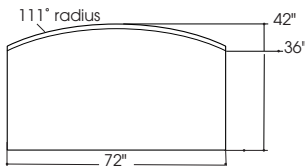

- Pedestal configuration:  
Left; file/file with one lock.  
Right; box/box/file with one lock.
- Recessed full-height modesty panel.  
TDDB-3672 with 11 1/2"(292mm) modesty recess on the sides, 17 1/2"(445mm) in center of bow front.
- Desk top available with wood veneer or plastic laminate.
- Accommodates separately-specified center pencil drawer and wire manager, see pages 78-79.
- Legal size pedestal standard for 72"(1829mm) width.
- Edge detail on user and visitor sides.
- Top, end panels, and modesty shipped unassembled.
- Standard price includes modular/steel drawers.

**To Order, Specify:**

- 1) Product number.  
–Specify edge detail as **9th digit** in product number.
  - 1 Square edge
  - 2 Bevel edge
  - 3 Chamfer edge
  - 4 Radius edge
 –Specify interior drawer construction as **10th digit** in product number.
  - S Modular/Steel.
  - W Wood, add \$450 list.
 –Specify grommet option as **11th digit** in product number.
  - V Left, add \$83 list.
  - Z Right, add \$83 list.
  - J Left and Right, add \$166 list.
  - N No grommet.
- 2) Wood finish color.
- 3) Plastic laminate finish color (if specified).

# Tripoli by SMED

## L-Desk with Full-Height Pedestals

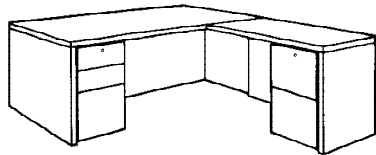

TLEF-3066-1SNR  
TLEF-3672-1SNR  
TLXF-3672-1SNR  
(Right shown)

Height	Depth	Width	Description	Number	Wood Finish Group				
					1	2	3	4	
29 1/2"(753mm)	30"(762mm)	66"(1676mm)	Desk	TLEF-3066-	■ ■ ■ ■	\$2910	\$3063	\$3216	\$3676
	21 1/2"(546mm)	42"(1067mm)	Return						
36"(914mm)	72"(1829mm)	42"(1067mm)	Desk	TLEF-3672-	■ ■ ■ ■	3049	3209	3369	3851
			21 1/2"(546mm)						
36"(914mm)	72"(1829mm)	42"(1067mm)	Desk	TLXF-3672-	■ ■ ■ ■	3435	3616	3797	4339
			24"(610mm)						

- Pedestal configuration:  
Desk has box/box/file with one lock.  
Return has file/file with one lock.
- Recessed full-height modesty panels.  
TLEF-3066 desk with 5 1/2"(140mm) recess.  
TLEF-3672 desk with 11 1/2"(292mm) recess.  
Both returns with 1 1/4"(32mm) recess.
- Cutout in modesty panel for wire management.
- Desk and return tops available with wood veneer or plastic laminate.
- Accommodates separately-specified center pencil drawer, keyboard pullout tray, adjustable keyboard pad, and wire manager, see pages 78-79.
- Legal size pedestal standard for 72"(1829mm) width.
- Letter size pedestal standard for 66"(1676mm) width.
- Edge detail on user and visitor sides of desk. Edge detail on user side of return.
- Tops, end panels, and modesty shipped unassembled.
- Standard price includes modular/steel drawers.

### To Order, Specify:

- 1) Product number.  
–Specify edge detail as **9th digit** in product number.
  - 1** Square edge
  - 2** Bevel edge
  - 3** Chamfer edge
  - 4** Radius edge
 –Specify interior drawer construction as **10th digit** in product number.
  - S** Modular/Steel
  - W** Wood, add \$450 list.
 –Specify grommet option as **11th digit** in product number.
  - V** Left on desk and pedestal end of return, add \$166 list.
  - Z** Right on desk and pedestal end of return, add \$166 list.
  - J** Left and right on desk and pedestal end of return, add \$249 list.
  - N** No grommet.
 –Specify orientation as **12th digit** in product number.
  - L** Left-handed
  - R** Right-handed
- 2) Wood finish color.
- 3) Plastic laminate finish color (if specified).

# Tripoli by SMED

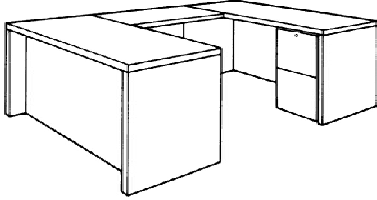
	Height	Depth	Width	Description	Number	Wood Finish Group				
						1	2	3	4	
<b>U-Station with Full-Height Pedestals</b>  	29 1/2"(753mm)	30"(762mm)	66"(1676mm)	Desk	TUEF-3066-	■ ■ ■ ■	\$3876	\$4096	\$4316	\$4975
		21 1/2"(546mm)	48"(1219mm)	Bridge						
		21 1/2"(546mm)	66"(1676mm)	Credenza						
	29 1/2"(753mm)	36"(914mm)	72"(1829mm)	Desk	TUEF-3672-	■ ■ ■ ■	4204	4441	4678	5389
		21 1/2"(546mm)	48"(1219mm)	Bridge						
		21 1/2"(546mm)	72"(1829mm)	Credenza						

TUEF-3066-1SN  
TUEF-3672-1SN

- Pedestal configuration:  
Desk has box/box/file with one lock.  
Credenza has file/file with one lock.
- Desk with recessed full-height modesty panel.
- Bridge with full-height modesty panel.
- Credenza with full-height back panel.
- Cutout in modesty panel for wire management.
- Desk, bridge, and credenza tops available with wood veneer or plastic laminate.
- Accommodates separately-specified center pencil drawer, keyboard pullout tray, adjustable keyboard pad, and wire manager, see pages 78-79.
- Legal size pedestal standard for 72"(1829mm) width.
- Letter size pedestal standard for 66"(1676mm) width.
- Edge detail on user and visitor sides of desk. Edge detail on user side of bridge and credenza.
- Tops, end panels, and modesty shipped unassembled.
- Standard price includes modular/steel drawers.

**To Order, Specify:**

- 1) Product number.  
–Specify edge detail as **9th digit** in product number.
  - 1** Square edge
  - 2** Bevel edge
  - 3** Chamfer edge
  - 4** Radius edge
 –Specify interior drawer construction as **10th digit** in product number.
  - S** Modular/Steel
  - W** Wood, add \$450 list.
 –Specify grommet option on desk as **11th digit** in product number.
  - V** Left on desk and both ends of credenza, add \$249 list.
  - Z** Right on desk and both ends of credenza, add \$249 list.
  - J** Left and right on desk and both ends of credenza, add \$332 list.
  - N** No grommet.
- 2) Wood finish color.
- 3) Plastic laminate finish color (if specified).

# Tripoli by SMED

	Height	Depth	Width	Number	Wood Finish Group			
					1	2	3	4
<b>Kneespace Credenza with Full-Height Pedestals</b>	29 1/2"(753mm)	21 1/2"(546mm)	66"(1676mm)	TCKF-2166- <input type="checkbox"/> <input type="checkbox"/> <input type="checkbox"/> <input type="checkbox"/>	\$1901	\$2001	\$2101	\$2401
			72"(1829mm)	TCKF-2172- <input type="checkbox"/> <input type="checkbox"/> <input type="checkbox"/> <input type="checkbox"/>	2019	2125	2231	2550

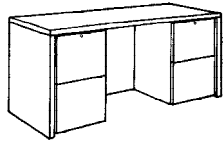

TCKF-2166-1SN  
TCKF-2172-1SN

- File/file pedestals with two locks.
- Cutout in back panel for wire management.
- Credenza top available with wood veneer or plastic laminate.
- Accommodates separately-specified keyboard pullout tray, adjustable keyboard pad, and wire manager, see pages 78-79.
- Legal size pedestal standard for 72"(1829mm) width.
- Letter size pedestal standard for 66"(1676mm) width.
- Edge detail on user side.
- Standard price includes steel drawers.

**To Order, Specify:**

- 1) Product number.
  - Specify edge detail as **9th digit** in product number.
 

<input type="checkbox"/> 1	Square edge
<input type="checkbox"/> 2	Bevel edge
<input type="checkbox"/> 3	Chamfer edge
<input type="checkbox"/> 4	Radius edge
  - Specify interior drawer construction as **10th digit** in product number.
 

<input type="checkbox"/> S	Steel
<input type="checkbox"/> W	Wood, add \$450 list.
  - Specify grommet option as **11th digit** in product number.
 

<input type="checkbox"/> V	Left, add \$83 list.
<input type="checkbox"/> Y	Center, add \$83 list.
<input type="checkbox"/> Z	Right, add \$83 list.
<input type="checkbox"/> J	Left and Right, add \$166 list.
<input type="checkbox"/> N	No grommet.
- 2) Wood finish color.
- 3) Plastic laminate finish color (if specified).

	Height	Depth	Width	Number	Wood Finish Group			
					1	2	3	4
<b>Door/Drawer Credenza with Full-Height Pedestals</b>	29 1/2"(753mm)	21 1/2"(546mm)	66"(1676mm)	TCF-2166- <input type="checkbox"/> <input type="checkbox"/> <input type="checkbox"/> <input type="checkbox"/>	\$2090	\$2200	\$2310	\$2640
			72"(1829mm)	TCF-2172- <input type="checkbox"/> <input type="checkbox"/> <input type="checkbox"/> <input type="checkbox"/>	2209	2325	2441	2790

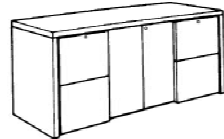

TCF-2166-1SNK  
TCF-2172-1SNK

- File/file pedestals with two locks.
- Center doors with optional locks with adjustable shelf.
- Cutout in back panel for wire management.
- Credenza top available with wood veneer or plastic laminate.
- Inside dimension of door unit 18"(457mm) deep x 29 1/2"(753mm) wide x 26 1/2"(676mm) high.
- Legal size pedestal standard for 72"(1829mm) width.
- Letter size pedestals standard for 66"(1676mm) width.
- Standard price includes steel drawers.

**To Order, Specify:**

- 1) Product number.
  - Specify edge detail as **8th digit** in product number.
 

<input type="checkbox"/> 1	Square edge
<input type="checkbox"/> 2	Bevel edge
<input type="checkbox"/> 3	Chamfer edge
<input type="checkbox"/> 4	Radius edge
  - Specify interior drawer construction as **9th digit** in product number.
 

<input type="checkbox"/> S	Steel
<input type="checkbox"/> W	Wood, add \$450 list.
  - Specify grommet option as **10th digit** in product number.
 

<input type="checkbox"/> V	Left, add \$83 list.
<input type="checkbox"/> Y	Center, add \$83 list.
<input type="checkbox"/> Z	Right, add \$83 list.
<input type="checkbox"/> J	Left and Right, add \$166 list.
<input type="checkbox"/> N	No grommet.
  - Specify center door lock option as **11th digit** in product number.
 

<input type="checkbox"/> N	No lock
<input type="checkbox"/> K	Lock, add \$150 list.
- 2) Wood finish color.
- 3) Plastic laminate finish color (if specified).

# Tripoli by SMED

	Height	Depth	Width	Number	Wood Finish Group			
					1	2	3	4
<b>Four Door Credenza</b>	29 1/2"(753mm)	21 1/2"(546mm)	66"(1676mm)	TCD-2166-	\$2105	\$2216	\$2327	\$2659
			72"(1829mm)	TCD-2172-	2160	2274	2388	2729

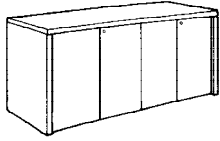

TCD-2166-1NK  
TCD-2172-1NK

- Full-height doors.
- Two compartments.
- One adjustable shelf per compartment.
- Cutout in back panel for wire management.
- Credenza top available with wood veneer or plastic laminate.
- Cannot field install a center grommet.

**To Order, Specify:**

- 1) Product number.
  - Specify edge detail as **8th digit** in product number.
    - 1** Square edge
    - 2** Bevel edge
    - 3** Chamfer edge
    - 4** Radius edge
  - Specify grommet option as **9th digit** in product number.
    - V** Left, add \$83 list.
    - Z** Right, add \$83 list.
    - J** Left and Right, add \$166 list.
    - N** No grommet.
  - Specify door lock option as **10th digit** in product number.
    - N** No lock
    - K** Lock, add \$300 list.
- 2) Wood finish color.
- 3) Plastic laminate finish color (if specified).

<b>Double File Credenza</b>	29 1/2"(753mm)	21 1/2"(546mm)	66"(1676mm)	TCFD-2166-				
					1	2	3	4
			72"(1829mm)	TCFD-2172-	2825	2974	3123	3569

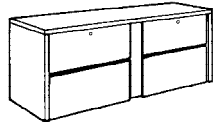

TCFD-2166-1SN  
TCFD-2172-1SN

- Two 30"(762mm) two drawer lateral files with front-mounted locks.
- Front-to-back filing bars provided.
- Cutout in back panel for wire management.
- Credenza top available with wood veneer or plastic laminate.
- Standard price includes steel drawers.

**To Order, Specify:**

- 1) Product number.
  - Specify edge detail as **9th digit** in product number.
    - 1** Square edge
    - 2** Bevel edge
    - 3** Chamfer edge
    - 4** Radius edge
  - Specify interior drawer construction as **10th digit** in product number.
    - S** Steel
    - W** Wood, add \$900 list.
  - Specify grommet option as **11th digit** in product number.
    - V** Left, add \$83 list.
    - Y** Center, add \$83 list.
    - Z** Right, add \$83 list.
    - J** Left and Right, add \$166 list.
    - N** No grommet.
- 2) Wood finish color.
- 3) Plastic laminate finish color (if specified).

# Tripoli by SMED

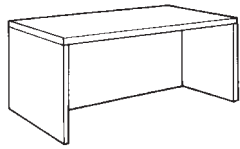

TRDL-1N

	Height	Depth	Width	Number	Wood Finish Group			
					1	2	3	4
Desk and Credenza Shells	29 1/2"(753mm)	21 1/2"(546mm)	48"(1219mm)	TRDL-2148-	1163	1224	1285	1469
			60"(1524mm)	TRDL-2160-	1205	1268	1331	1522
			66"(1676mm)	TRDL-2166-	1213	1277	1341	1532
			72"(1829mm)	TRDL-2172-	1258	1324	1390	1589
	29 1/2"(753mm)	24"(610mm)	48"(1219mm)	TRDL-2448-	1240	1305	1370	1566
			60"(1524mm)	TRDL-2460-	1273	1340	1407	1608
			66"(1676mm)	TRDL-2466-	1292	1360	1428	1632
			72"(1829mm)	TRDL-2472-	1340	1411	1482	1693
	29 1/2"(753mm)	30"(762mm)	60"(1524mm)	TRDL-3060-	1358	1429	1500	1715
			66"(1676mm)	TRDL-3066-	1392	1465	1538	1758
			72"(1829mm)	TRDL-3072-	1524	1604	1684	1925
			29 1/2"(753mm)	36"(914mm)	72"(1829mm)	TRDL-3672-	1542	1623
	84"(2134mm)	TRDL-3684-			1772	1865	1958	2238

- Recessed full-height modesty panel.
  - 1 1/4"(32mm) recess on 21 1/2"(546mm) and 24"(610mm) depth.
  - 5 1/2"(140mm) recess on 30"(762mm) depth.
  - 11 1/2"(292mm) recess on 36"(914mm) depth.
- Cutout in modesty panel for wire management.
- Accepts separately-specified pedestals from pages 70-71.
- Desk shell top available with wood veneer or plastic laminate.
- Accommodates separately-specified center pencil drawer, convenience outlet strip, and wire manager, see pages 78-79.
- Edge detail on user and visitor sides.
- Shipped unassembled.

### To Order, Specify:

- 1) Product number.
  - Specify edge detail as **9th digit** in product number.
 

1	Square edge
2	Bevel edge
3	Chamfer edge
4	Radius edge
  - Specify grommet option as **10th digit** in product number.
 

V	Left, add \$83 list.
Y	Center, add \$83 list.
Z	Right, add \$83 list.
J	Left and Right, add \$166 list.
N	No grommet.
- 2) Wood finish color.
- 3) Plastic laminate finish color (if specified).

# Tripoli by SMED

	Height	Depth	Width	Number	Wood Finish Group			
					1	2	3	4
<b>Desk with Bow Front Shell</b>	29 1/2"(753mm)	36"(914mm)	72"(1829mm)	TBDL-3672- <input type="checkbox"/> <input type="checkbox"/>	\$1804	\$1899	\$1994	\$2279

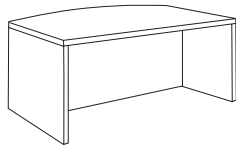

TBDL-3672-1N

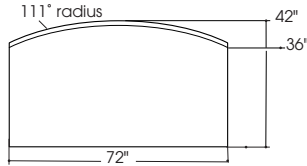

- Recessed full-height modesty panel. TBDL-3672 with 11 1/2"(292mm) modesty recess on the sides, 17 1/2"(445mm) in center of bow front.
- Cutout in modesty panel for wire management.
- Accepts separately-specified pedestals from pages 70-71.
- Desk shell top available with wood veneer or plastic laminate.
- Accommodates separately-specified center pencil drawer, convenience outlet strip, and wire manager, see pages 78-79.
- Edge detail on user and visitor sides.
- Shipped unassembled.

**To Order, Specify:**

- 1) Product number.
  - Specify edge detail as **9th digit** in product number.
 

<b>1</b>	Square edge
<b>2</b>	Bevel edge
<b>3</b>	Chamfer edge
<b>4</b>	Radius edge
  - Specify grommet option as **10th digit** in product number.
 

<b>V</b>	Left, add \$83 list.
<b>Y</b>	Center, add \$83 list.
<b>Z</b>	Right, add \$83 list.
<b>J</b>	Left and Right, add \$166 list.
<b>N</b>	No grommet.
- 2) Wood finish color.
- 3) Plastic laminate finish color (if specified).

# Tripoli by SMED

	Height	Depth	Width	Number	Wood Finish Group			
					1	2	3	4

## D-Top Desk Extension

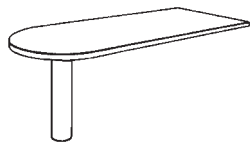

TRND-3072-1N

29 1/2"(753mm) 30"(762mm) 72"(1829mm)

TRND-3072-

\$1492 \$1571 \$1650 \$1885

- 6" (152mm) diameter veneer cylinder base.
- All connecting hardware included.
- Desk extension top available with wood veneer or plastic laminate.
- Accommodates separately-specified center pencil drawer, see page 78.
- Shipped unassembled.
- Attaches to a return or bridge only and cannot be specified as a freestanding desk.

### To Order, Specify:

- 1) Product number.  
 -Specify edge detail as **9th digit** in product number.
  - 1** Square edge
  - 2** Bevel edge
  - 3** Chamfer edge
  - 4** Radius edge
 -Specify grommet option as **10th digit** in product number.
  - V** Left, add \$83 list.
  - Z** Right, add \$83 list.
  - N** No grommet.
- 2) Wood finish color.
- 3) Plastic laminate finish color (if specified).

## D-Top Desk Extension with End Panel

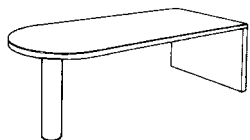

TRED-3072-1N

29 1/2"(753mm) 30"(762mm) 72"(1829mm)

TRED-3072-

\$1946 \$2048 \$2150 \$2458

- 6" (152mm) diameter veneer cylinder base.
- All connecting hardware included.
- Desk extension top available with wood veneer or plastic laminate.
- Accommodates separately-specified center pencil drawer, see page 78.
- Shipped unassembled.
- Standard with filler strip for connection to bridge modesty.
- Attaches to a return or bridge only and cannot be specified as a freestanding desk.

### To Order, Specify:

- 1) Product number.  
 -Specify edge detail as **9th digit** in product number.
  - 1** Square edge
  - 2** Bevel edge
  - 3** Chamfer edge
  - 4** Radius edge
 -Specify grommet option as **10th digit** in product number.
  - V** Left, add \$83 list.
  - Z** Right, add \$83 list.
  - N** No grommet.
- 2) Wood finish color.
- 3) Plastic laminate finish color (if specified).



# Tripoli by SMED

	Height	Depth	Width	Number	Wood Finish Group			
					1	2	3	4
D-Top Desk with Modesty Panel	29 1/2"(753mm)	30"(762mm)	72"(1829mm)	TRMD-3072- <span style="display: inline-block; width: 15px; height: 15px; background-color: #ccc; border: 1px solid #ccc;"></span> <span style="display: inline-block; width: 15px; height: 15px; background-color: #ccc; border: 1px solid #ccc;"></span> <span style="display: inline-block; width: 15px; height: 15px; background-color: #ccc; border: 1px solid #ccc;"></span>	\$2263	\$2382	\$2501	\$2858

**D-Top Desk with Modesty Panel**

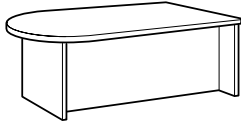

TRMD-3072-1NFR  
(Right shown)

- All connecting hardware included.
- D-top desk available with wood veneer or plastic laminate.
- Accommodates separately-specified center pencil drawer, see page 78.
- Shipped unassembled.
- Approach overhang is 9 3/4"(248mm).

**To Order, Specify:**

- Product number.
  - Specify edge detail as **9th digit** in product number.
 

<b>1</b>	Square edge
<b>2</b>	Bevel edge
<b>3</b>	Chamfer edge
<b>4</b>	Radius edge
  - Specify grommet option as **10th digit** in product number.
 

<b>V</b>	Left, add \$83 list.
<b>Z</b>	Right, add \$83 list.
<b>N</b>	No grommet.
  - Specify modesty panel as **11th digit** in product number.
 

<b>F</b>	Full Height
<b>Q</b>	3/4 height, subtract \$31 list
  - Specify desk orientation as **12th digit** in product number.
 

<b>L</b>	Left-handed
<b>R</b>	Right-handed
- Wood finish color.
- Plastic laminate finish color (if specified).

# Tripoli by SMED

	Height	Depth	Width	Number	Wood Finish Group			
					1	2	3	4
<b>P-Top Desk Extension</b>	29 1/2"(753mm)	30"(762mm)	72"(1829mm)	TRNP-3072- <input type="checkbox"/> <input type="checkbox"/> <input type="checkbox"/>	\$2206	\$2322	\$2438	\$2786

**P-Top Desk Extension**

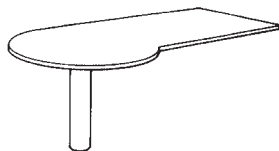

TRNP-3072-1NR  
(Right shown)

- 36"(914mm) diameter conference end.
- 6"(152mm) diameter veneer cylinder base.
- Specify left- or right-hand configuration.
- All connecting hardware included.
- Desk extension top available with wood veneer or plastic laminate.
- Accommodates separately-specified center pencil drawer, see page 78.
- Shipped unassembled.
- Attaches to a return or bridge only and cannot be specified as a freestanding desk.

**To Order, Specify:**

- 1) Product number.
  - Specify edge detail as **9th digit** in product number.
    - 1** Square edge
    - 2** Bevel edge
    - 3** Chamfer edge
    - 4** Radius edge
  - Specify grommet option as **10th digit** in product number.
    - V** Left, add \$83 list.
    - Z** Right, add \$83 list.
    - N** No grommet.
  - Specify top orientation as **11th digit** in product number.
    - L** Left-handed
    - R** Right-handed
- 2) Wood finish color.
- 3) Plastic laminate finish color (if specified).

**P-Top Desk Extension with End Panel**

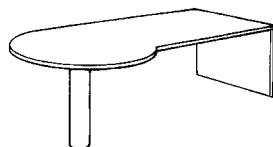

TREP-3072-1NR  
(Right shown)

	29 1/2"(753mm)	30"(762mm)	72"(1829mm)	TREP-3072- <input type="checkbox"/> <input type="checkbox"/> <input type="checkbox"/>	\$2672	\$2813	\$2954	\$3376
--	----------------	------------	-------------	---	--------	--------	--------	--------

- 36"(914mm) diameter conference end.
- 6"(152mm) diameter veneer cylinder base.
- Specify left- or right-hand configuration.
- All connecting hardware included.
- Desk extension top available with wood veneer or plastic laminate.
- Accommodates separately-specified center pencil drawer, see page 78.
- Shipped unassembled.
- Standard with gap filler for connection to bridge modesty.
- Attaches to a return or bridge only and cannot be specified as a freestanding desk.

**To Order, Specify:**

- 1) Product number.
  - Specify edge detail as **9th digit** in product number.
    - 1** Square edge
    - 2** Bevel edge
    - 3** Chamfer edge
    - 4** Radius edge
  - Specify grommet option as **10th digit** in product number.
    - V** Left, add \$83 list.
    - Z** Right, add \$83 list.
    - N** No grommet.
  - Specify top orientation as **11th digit** in product number.
    - L** Left-handed
    - R** Right-handed
- 2) Wood finish color.
- 3) Plastic laminate finish color (if specified).

# Tripoli by SMED

	Height	Depth	Width	Number	Wood Finish Group			
					1	2	3	4
	29 1/2"(753mm)	30"(762mm)	72"(1829mm)	TRMP-3072- <span style="display: inline-block; width: 1em; height: 1em; background-color: #ccc; border: 1px solid #000;"></span> <span style="display: inline-block; width: 1em; height: 1em; background-color: #ccc; border: 1px solid #000;"></span> <span style="display: inline-block; width: 1em; height: 1em; background-color: #ccc; border: 1px solid #000;"></span> <span style="display: inline-block; width: 1em; height: 1em; background-color: #ccc; border: 1px solid #000;"></span>	\$2990	\$3147	\$3304	\$3776

**P-Top Desk with Modesty Panel**

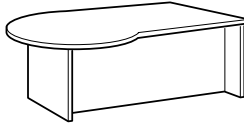

TRMP-3072-1NFR  
(Right shown)

- 36"(914mm) diameter conference end.
- Specify left- or right-hand configuration.
- All connecting hardware included.
- Desk extension top available with wood veneer or plastic laminate.
- Accommodates separately-specified center pencil drawer, see page 78.
- Shipped unassembled.
- Approach overhang is 9 3/4"(248mm).

**To Order, Specify:**

- 1) Product number.
  - Specify edge detail as **9th digit** in product number.
    - 1** Square edge
    - 2** Bevel edge
    - 3** Chamfer edge
    - 4** Radius edge
  - Specify grommet option as **10th digit** in product number.
    - V** Left, add \$83 list.
    - Z** Right, add \$83 list.
    - N** No grommet.
  - Specify modesty panel as **11th digit** in product number.
    - F** Full Height
    - Q** 3/4 height, subtract \$31 list
  - Specify desk orientation as **12th digit** in product number.
    - L** Left-handed
    - R** Right-handed
- 2) Wood finish color.
- 3) Plastic laminate finish color (if specified).

# Tripoli by SMED

**Return**

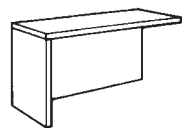

TRRE-1NFL  
(Left shown)

Height	Depth	Width	Number	Wood Finish Group				
				1	2	3	4	
29 1/2"(753mm)	21 1/2"(546mm)	42"(1067mm)	TRRE-2142-	■ ■ ■ ■	\$ 844	\$ 888	\$ 932	\$1066
		48"(1219mm)	TRRE-2148-	■ ■ ■ ■	898	945	992	1134
		66"(1670mm)	TRRE-2166-	■ ■ ■ ■	907	955	1003	1146
		72"(1829mm)	TRRE-2172-	■ ■ ■ ■	918	966	1014	1159
29 1/2"(753mm)	24"(610mm)	48"(1219mm)	TRRE-2448-	■ ■ ■ ■	\$ 987	\$1039	\$1091	\$1247
		52"(1321mm)	TRRE-2452-	■ ■ ■ ■	1045	1100	1155	1320
		66"(1670mm)	TRRE-2466-	■ ■ ■ ■	1001	1054	1107	1265
		72"(1829mm)	TRRE-2472-	■ ■ ■ ■	1017	1071	1125	1285
29 1/2"(753mm)	30"(762mm)	66"(1670mm)	TRRE-3066-	■ ■ ■ ■	\$1079	\$1136	\$1193	\$1363
		72"(1829mm)	TRRE-3072-	■ ■ ■ ■	1117	1176	1235	1411

- Return shell with one end panel.
- Full-height modesty panel with 1 1/4"(32mm) recess.
- Cutout in modesty panel for wire management.
- Accepts separately-specified pedestals from pages 70-71.
- Return top available with wood veneer or plastic laminate.
- Accommodates separately-specified center pencil drawer, keyboard pullout tray (24"(610mm) or deep returns only), adjustable keyboard pad, convenience outlet strip, and wire manager, see page 78-79.
- All connecting hardware included.
- Shipped unassembled.
- Edge detail on user side.

**To Order, Specify:**

- Product number.
  - Specify edge detail as **9th digit** in product number.
 

<b>1</b>	Square edge
<b>2</b>	Bevel edge
<b>3</b>	Chamfer edge
<b>4</b>	Radius edge
  - Specify grommet option as **10th digit** in product number.
 

<b>V</b>	Left, add \$83 list.
<b>Z</b>	Right, add \$83 list.
<b>J</b>	Left and Right, add \$166 list.
<b>N</b>	No grommet.
  - Specify modesty panel as **11th digit** in product number.
 

<b>F</b>	Full Height
<b>Q</b>	3/4 height, subtract \$67 list
  - Specify return orientation as **12th digit** in product number.
 

<b>L</b>	Left-handed
<b>R</b>	Right-handed
- Wood finish color.
- Plastic laminate finish color (if specified).

# Tripoli by SMED

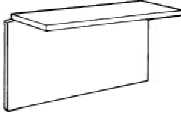
	Height	Depth	Width	Number	Wood Finish Group			
					1	2	3	4
<b>Bridge</b> 	29 1/2"(753mm)	21 1/2"(546mm)	42"(1067mm)	TRBE-2142-	\$ 804	\$ 846	\$ 888	\$1015
			48"(1219mm)	TRBE-2148-	860	905	950	1086
	24"(610mm)	42"(1067mm)	TRBE-2442-	\$ 860	\$ 905	\$ 950	\$1086	
			48"(1219mm)	TRBE-2448-	949	999	1049	1199
	30"(762mm)	42"(1067mm)	TRBE-3042-	\$1008	\$1061	\$1114	\$1273	
			48"(1219mm)	TRBE-3048-	1027	1081	1135	1297

TRBE-1NF

- Unit has cutout at top center.
- All connecting hardware included.
- Bridge top available with wood veneer or plastic laminate.
- Accommodates separately-specified center pencil drawer, keyboard pullout tray (24"(610mm) or deep bridges only), adjustable keyboard pad, convenience outlet strip, and wire manager, see page 78-79.
- Shipped unassembled.
- Edge detail on user side.

**To Order, Specify:**

- Product number.
  - Specify edge detail as **9th digit** in product number.
 

1	Square edge
2	Bevel edge
3	Chamfer edge
4	Radius edge
  - Specify grommet option as **10th digit** in product number.
 

Y	Center, add \$83 list.
N	No grommet.
  - Specify modesty panel as **11th digit** in product number.
 

F	Full Height
Q	3/4 height, subtract \$67 list
- Wood finish color.
- Plastic laminate finish color (if specified).

**Filler Strip**

27 1/16"(687mm)	3/4"(19mm)	1 1/4"(32mm)	LFIL-1	\$64
-----------------	------------	--------------	--------	------

- Specify when a shell or desk will be connected to a bridge/return.
- Fills the gap between the bridge/return modesty panel and shell desk end panel.

**To Order, Specify:**

- Product number.
- Wood finish color.

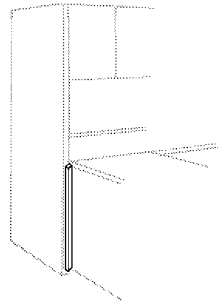

LFIL-1

# Tripoli by SMED

	Height	Clearance	Depth	Width	Description	Number	Wood Finish Group			
							1	2	3	4
<b>Vertical Storage Unit</b>	34 3/8"(873mm)	18"(457mm)	16 3/4"(429mm)	66"(1676mm)	Four doors	TRVS-3566-	\$1722	\$1813	\$1904	\$2176
				72"(1829mm)	Four doors	TRVS-3572-	1820	1916	2012	2299
				84"(2134mm)	Six doors	TRVS-3584-	2016	2122	2228	2546
	38 1/4"(971mm)	22"(559mm)	16 3/4"(429mm)	66"(1676mm)	Four doors	TRVS-3966-	\$1797	\$1892	\$1987	\$2270
				72"(1829mm)	Four doors	TRVS-3972-	1897	1997	2097	2396
				84"(2134mm)	Six doors	TRVS-3984-	2120	2220	2320	2619

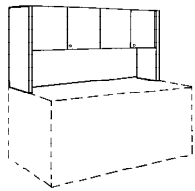

TRVS-3572-K

- Specify with same width desk, credenza, or return. When spanning multiple casegoods, the combined width must match the vertical storage width.
- Accepts separately-specified task lighting, see page 63.
- Lower shelf construction is 16 gauge steel with charcoal finish.
- Doors are locked in pairs; for example six doors will have three (3) locks.
- 39"(991mm) high units accommodate larger monitors and will be higher than wardrobes and bookcases.
- Accepts separately-specified tackboards, see below.

**To Order, Specify:**

- 1) Product number.  
 -Specify door lock option as **9th digit** in product number.  

<b>N</b>	No lock
<b>K</b>	Lock, add \$300 list for four doors, add \$450 list for six doors.
- 2) Wood finish color.

**Vertical Storage Unit – Tackboards**

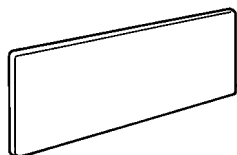

TTBV-1972

Height	Depth	Width	COM Requirement	Number	Fabric Grade		
					A	B	C
18"(457mm)	1 3/16"(30mm)	63"(1600mm)	2 yards	TTBV-1966	\$210	\$221	\$242
		69"(1753mm)	2.5 yards	TTBV-1972	238	250	274
		81"(2057mm)	3 yards	TTBV-1984	271	285	312
22"(559mm)	1 3/16"(30mm)	63"(1600mm)	2 yards	TTBV-2466	\$224	\$235	\$258
		69"(1753mm)	2.5 yards	TTBV-2472	257	270	296
		81"(2057mm)	3 yards	TTBV-2484	286	300	329

- Fabric covered.
- 63"(1600mm) and 69"(1753mm) width tackboards ship as one piece.
- 81"(2057mm) width tackboards ship as two pieces.
- Attachment hardware included.
- Mounts on a vertical storage unit.
- COM fabric is railroad.

**To Order, Specify:**

- 1) Product number.
- 2) Fabric surface and color.

# Tripoli by SMED

	Height	Depth	Width	Description	Number	Price
<b>Fixed-Intensity Task Lighting (Steel Bottom Vertical Storage Unit)</b>	1 1/2" (38mm)	6 7/8" (175mm)	24.3" (617mm)		YHTL-0024-T	\$167
			36.3" (922mm)		YHTL-0036-T	187
			48.3" (1227mm)		YHTL-0048-T	195
	1 1/2" (38mm)	6 7/8" (175mm)	24.3" (617mm)	Chicago task light	YHTL-0024-TC	220
			36.3" (922mm)	Chicago task light	YHTL-0036-TC	252
			48.3" (1227mm)	Chicago task light	YHTL-0048-TC	260

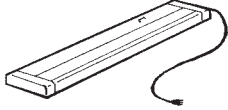

YHTL-0024-T  
Class RB

- Provides task lighting beneath overhead and vertical storage units.
- Task light width must be less than width of storage unit.
- Includes mounting hardware, lens, and cord to attach to steel bottom shelf of vertical storage unit.
- Nine-foot cord is factory-installed on right side; may be field-installed on left side.
- Units shipped with T-8 octic tri-phosphoric lamp with a 3500K color temperature.
- **For use with 120 volt 60 hertz electrical systems only.**
- Standard with black finish.

**To Order, Specify:**

- 1) Product number.  
(No finish specification required.)

Task Light Application Matrix			
Overhead Storage	24.3" Task Light	36.3" Task Light	48.3" Task Light
24" - No light available			
30"	1		
36"	1		
66"	2	1	1
72"	2	1	1
84"	3	2	1

For full length lighting, (2) 24.3" wide lights will mount under overhead storage units 54" wide and above. Additional combination not exceeding the width of the overhead could be used.

**Overhead Cabinet**



TROC-7264-K  
Class RA

Height	Depth	Width	Description	Number	Wood Finish Group			
					1	2	3	4
17 1/4" (438mm)	16 3/4" (429mm)	24" (610mm)	Two doors	TROC-2464-█	\$1415	\$1490	\$1565	\$1788
		30" (762mm)	Two doors	TROC-3064-█	1450	1526	1602	1831
		36" (914mm)	Two doors	TROC-3664-█	1478	1556	1634	1867
		66" (1676mm)	Four doors	TROC-6664-█	2155	2268	2381	2722
		72" (1829mm)	Four doors	TROC-7264-█	2214	2331	2448	2797

- Matched grain doors.
- Hardware includes continuous extruded metal support clip for mounting.
- Accepts separately specified task lighting, see above.
- Unit has center partition; separate compartment behind each door set.
- Lower shelf construction is 16 gauge steel with charcoal finish.
- Inside height dimension 13 1/2" (341mm).

**To Order, Specify:**

- 1) Product number.  
–Specify door lock option as **9th digit** in product number.  

<b>N</b>	No lock
<b>K</b>	Lock, add \$150 list for two doors, add \$300 list for four doors.
- 2) Wood finish color.

# Tripoli by SMED

	Height	Depth	Width	Description	Number	Wood Finish Group			
						1	2	3	4
<b>Overhead Cabinet with Shelves</b>	29 1/8" (740mm)	16 3/4" (429mm)	24" (610mm)	Two doors	TROC-2476-	\$1627	\$1713	\$1799	\$2056
			30" (762mm)	Two doors	TROC-3076-	1678	1766	1854	2119
			36" (914mm)	Two doors	TROC-3676-	1717	1807	1897	2168
			66" (1676mm)	Four doors	TROC-6676-	2441	2570	2699	3084
			72" (1829mm)	Four doors	TROC-7276-	2519	2652	2785	3182

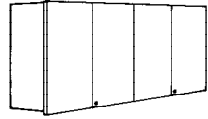

TROC-7276-K

- Matched grain doors.
- One adjustable shelf per compartment.
- Hardware includes continuous extruded metal support clip for mounting.
- Accepts separately specified task lighting , see page 63.
- Inside height dimension 25 1/4" (643mm).
- Lower shelf construction is 16 gauge steel with charcoal finish.

**To Order, Specify:**

- 1) Product number.  
 -Specify door lock option as **9th digit** in product number.  

<b>N</b>	No lock
<b>K</b>	Lock, add \$150 list for two doors, add \$300 list for four doors.
- 2) Wood finish color.

**Tackboard — Wall Mount**

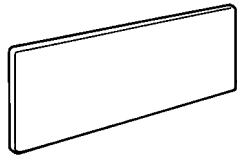

LTB-1872

Height	Depth	Width	COM Requirement	Number	Fabric Grade		
					A	B	C
17 5/8" (448mm)	1 3/16" (30mm)	24" (610mm)	1 yard	LTB-1824	\$ 98	\$105	\$120
		30" (762mm)	1 yard	LTB-1830	117	124	139
		36" (914mm)	1.5 yards	LTB-1836	133	140	155
		66" (1676mm)	2 yards	LTB-1866	206	217	239
		72" (1829mm)	2.5 yards	LTB-1872	233	244	266

- Fabric covered.
- Mounts below overhead cabinets.
- Wall-mounting attachment hardware included.

**To Order, Specify:**

- 1) Product number.
- 2) Fabric surface and color.

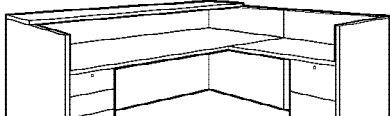

# Tripoli by SMED

	Height	Depth	Width	Description	Number	Wood Finish Group				
						1	2	3	4	
<b>Reception L-Desk</b> 	43 3/4"(1111mm)	82 1/2"(2096mm)	72"(1829mm)	Enclosure	TLDR-8272-	■ ■ ■ ■ ■	\$6916	\$7280	\$7644	\$8736
	28 3/4"(730mm)	34 1/2"(876mm)	72"(1829mm)	Desk						
	28 3/4"(730mm)	21 1/2"(546mm)	48"(1219mm)	Return						
	43 3/4"(1111mm)	82 1/2"(2096mm)	84"(2134mm)	Enclosure	TLDR-8284-	■ ■ ■ ■ ■	\$7025	\$7395	\$7765	\$8874
	28 3/4"(730mm)	34 1/2"(876mm)	84"(2134mm)	Desk						
	28 3/4"(730mm)	21 1/2"(546mm)	48"(1219mm)	Return						

TLDR-8272-1SNR  
 TLDR-8284-1SNR  
 (Right shown)

- Full-height pedestals.
- Pedestal configuration:  
 Desk has box/box/file with one lock.  
 Return has file/file with lock.
- Transaction shelf depth is 11 1/2"(292mm).
- Top with one 1 1/2"(38mm) x 4"(102mm) wire opening at back edge.
- Desk, return tops, and transaction shelf available with wood veneer or plastic laminate.
- Accommodates separately-specified center pencil drawer, keyboard pullout tray, and adjustable keyboard pad, see page 78.
- Galley walls, worksurfaces, and transition tops are shipped unassembled.
- Edge detail on user side of worksurface and both sides of transaction counter.
- Standard price includes modular/steel drawers.

**To Order, Specify:**

- 1) Product number.  
 -Specify edge detail as **9th digit** in product number.
  - 1** Square edge
  - 2** Bevel edge
  - 3** Chamfer edge
  - 4** Radius edge
 -Specify interior drawer construction as **10th digit** in product number.
  - S** Modular/steel
  - W** Wood, add \$450 list.
 -Specify grommet option as **11th digit** in product number.
  - V** Left on desk and pedestal end of return, add \$166 list.
  - Z** Right on desk and pedestal end of return, add \$166 list.
  - J** Left and Right on desk and pedestal end of return, add \$249 list.
  - N** No grommet.
 -Specify return orientation as **12th digit** in product number.
  - L** Left-handed
  - R** Right-handed
- 2) Wood finish color.
- 3) Plastic laminate finish color (if specified).

# Tripoli by SMED

	Height	Depth	Width	Description	Number	Wood Finish Group				
						1	2	3	4	
<b>Reception U-Desk</b>	43 3/4"(1111mm)	104"(2642mm)	72"(1829mm)	Enclosure	TUDR-3672-	■ ■ ■ ■	\$7863	\$8277	\$8691	\$9932
	28 3/4"(730mm)	34 1/2"(876mm)	72"(1829mm)	Desk						
	28 3/4"(730mm)	20 1/16"(490mm)	48"(1219mm)	Bridge						
	28 3/4"(730mm)	21 1/2"(546mm)	72"(1829mm)	Credenza						

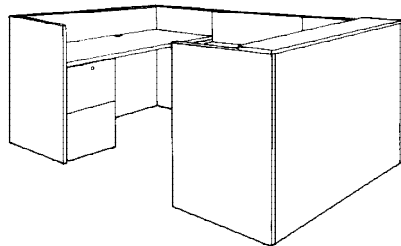

TUDR-3672-1SNL  
(Left shown)

- Full-height pedestals.
- Pedestal configuration:  
Desk box/box/file with one lock. Credenza has file/file with one lock.
- Transaction shelf depth is 11 1/2"(292mm).
- Desk top and credenza with one 1 1/2"(38mm) x 4"(102mm) wire opening at back edge in the center.
- Desk, bridge, credenza tops and transaction shelf available with wood veneer or plastic laminate.
- Accommodates separately-specified center pencil drawer, keyboard pullout tray, and adjustable keyboard pad, see page 78.
- Desk, bridge and credenza shipped separately. Bridge shipped unassembled.
- Only user edge has edge detail.
- Galley walls, worksurfaces, and transition tops ship unassembled.
- Standard price includes modular/steel drawers.

### To Order, Specify:

- Product number.  
–Specify edge detail as **9th digit** in product number.
  - 1** Square edge
  - 2** Bevel edge
  - 3** Chamfer edge
  - 4** Radius edge
 –Specify interior drawer construction as **10th digit** in product number.
  - S** Modular/steel
  - W** Wood, add \$450 list.
 –Specify grommet option as **11th digit** in product number.
  - V** Left on desk, and both ends of credenza, add \$249 list.
  - Z** Right on desk, and both ends of credenza, add \$249 list.
  - J** Left and Right on desk, and both ends of credenza, add \$332 list.
  - N** No grommet.
 –Specify return orientation as **12th digit** in product number.
  - L** Left-handed
  - R** Right-handed
- Wood finish color.
- Plastic laminate finish color (if specified).

# Tripoli by SMED

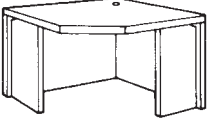
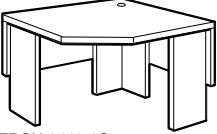
	Height	Depth	Width	Description	Number	Wood Finish Group															
						1	2	3	4												
<b>Corner Unit</b>   TRCU-2442-1F TRCU-3042-1F   TRCU-2442-1Q TRCU-3042-1Q Class RA	29 1/2"(753mm)	42"(1067mm)	42"(1067mm)	Used with 24"(610mm) deep returns and bridges	TRCU-2442-	\$1542	\$1623	\$1704	\$1948												
				Used with 30"(762mm) deep returns and bridges	TRCU-3042-	1642	1728	1814	2074												
<ul style="list-style-type: none"> <li>Finished wood back and end panels.</li> <li>Wireway grommet (black only) in back corner.</li> <li>Support legs notched for wire management.</li> <li>All connecting hardware included.</li> <li>Top available with wood veneer or plastic laminate.</li> <li>Accommodates separately-specified adjustable keyboard pad, convenience outlet strip and wire manager tray, see pages 78-79.</li> <li>Not to be used as freestanding furniture.</li> <li>Shipped unassembled.</li> <li>Edge detail on user side.</li> </ul>						<b>To Order, Specify:</b> 1) Product number. –Specify edge detail as <b>9th digit</b> in product number. <table border="0"> <tr><td><b>1</b></td><td>Square edge</td></tr> <tr><td><b>2</b></td><td>Bevel edge</td></tr> <tr><td><b>3</b></td><td>Chamfer edge</td></tr> <tr><td><b>4</b></td><td>Radius edge</td></tr> </table> –Specify modesty panel as <b>10th digit</b> in product number. <table border="0"> <tr><td><b>F</b></td><td>Full Height</td></tr> <tr><td><b>Q</b></td><td>3/4 height, subtract <b>\$39</b> list</td></tr> </table> 2) Wood finish color. 3) Plastic laminate finish color (if specified).				<b>1</b>	Square edge	<b>2</b>	Bevel edge	<b>3</b>	Chamfer edge	<b>4</b>	Radius edge	<b>F</b>	Full Height	<b>Q</b>	3/4 height, subtract <b>\$39</b> list
<b>1</b>	Square edge																				
<b>2</b>	Bevel edge																				
<b>3</b>	Chamfer edge																				
<b>4</b>	Radius edge																				
<b>F</b>	Full Height																				
<b>Q</b>	3/4 height, subtract <b>\$39</b> list																				

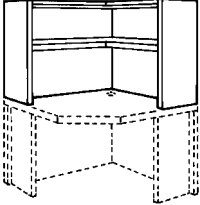
<b>Corner Vertical Storage Unit</b>   TRVS-3542 Class RA	34 3/8"(873mm)	42"(1067mm)	42"(1067mm)	Overhead storage for corner units	TRVS-3542	\$2246	\$2364	\$2482	\$2837
	<ul style="list-style-type: none"> <li>Used with corner floor unit.</li> <li>Finished wood back and 1 1/4"(32mm) end panels.</li> <li>Overall depth is 16 3/4"(429mm).</li> <li>Shelf depth is 15"(383mm).</li> <li>Accepts separately-specified task lighting, see below.</li> <li>Concealed wire pass-through.</li> </ul>						<b>To Order, Specify:</b> 1) Product number. 2) Wood finish color.		

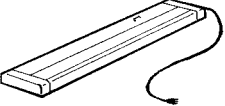
<b>Fixed-Intensity Task Lighting (Wood Bottom Vertical Storage Unit)</b>   YHTL-0024-WT YHTL-0024-WTC Class RB	1 1/2"(38mm)	6 7/8"(175mm)	24.3"(617mm)	Chicago task light	YHTL-0024-WT	\$167			
			24.3"(617mm)		YHTL-0024-WTC	220			
<ul style="list-style-type: none"> <li>Provides task lighting beneath overhead and vertical storage units.</li> <li>Task light width must be less than width of storage unit.</li> <li>Includes (1) set of mounting screws, lens, and cord to attach to wood bottom shelf of corner vertical storage unit.</li> <li>Nine-foot cord is factory-installed on right side; may be field-installed on left side.</li> <li>Units shipped with T-8 octic tri-phosphoric lamp with a 3500K color temperature.</li> <li><b>For use with 120 volt 60 hertz electrical systems only.</b></li> </ul>						<b>To Order, Specify:</b> 1) Product number. (No finish specification required.)			

# Tripoli by SMED

	Height	Depth	Width	COM Requirement Number		Fabric Grade		
						A	B	C
<b>Corner Vertical Storage Unit Tackboard</b>	20"(508mm)	1 3/16"(30mm)	42"(1067mm)	3 yds.	TTBC-1942	\$296	\$312	348

**Corner Vertical Storage Unit Tackboard**

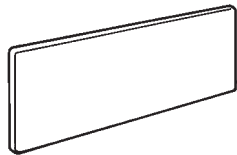

TTBC-1942

- Fabric covered.
- Attachment hardware included.
- Mounts on a corner vertical storage unit.
- Tackboard ships as two pieces.

**To Order, Specify:**

- 1) Product number.
- 2) Fabric surface and color.

	Height	Depth	Width	Number		Wood Finish Group			
						1	2	3	4
<b>CRT Table</b>	29 1/2"(753mm)	24"(610mm)	32"(813mm)	TRCS-2429-	■ ■ ■	\$953	\$1003	\$1053	\$1204

**CRT Table**

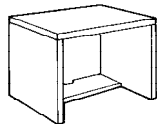

TRCS-2429-1NG

- Full-height finished back with full length wireway access under top.
- Storage shelf with wireway cutout.
- Adjustable glides, or four casters (2 locking).
- Top available with wood veneer or plastic laminate.
- Accommodates separately-specified keyboard pullout tray or adjustable keyboard pad, see page 78.
- Height is the same with glides or casters.
- Edge detail on user side.

**To Order, Specify:**

- 1) Product number.  
–Specify edge detail as **9th digit** in product number.

- 1** Square edge
- 2** Bevel edge
- 3** Chamfer edge
- 4** Radius edge

–Specify grommet option as **10th digit** in product number.

- Y** Center, add \$83 list.
- N** No grommet.

–Specify caster option as **11th digit** in product number.

- G** Glides
- C** Casters, add \$44 list.

- 2) Wood finish color.
- 3) Plastic laminate finish color (if specified).

	Height	Depth	Width	Number		Wood Finish Group			
						1	2	3	4
<b>Printer Unit</b>	29 1/2"(753mm)	24"(610mm)	32"(813mm)	TRPU-2429-	■ ■ ■	\$1053	\$1108	\$1163	\$1330

**Printer Unit**

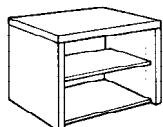

TRPU-2429-1NG

- Full-height finished back with full length wireway access under top.
- One adjustable shelf.
- Adjustable glides, or four casters (2 locking).
- Top available with wood veneer or plastic laminate.
- Height is the same with glides or casters.
- Edge detail on user side.

**To Order, Specify:**

- 1) Product number.  
–Specify edge detail as **9th digit** in product number.

- 1** Square edge
- 2** Bevel edge
- 3** Chamfer edge
- 4** Radius edge

–Specify grommet option as **10th digit** in product number.

- Y** Center, add \$83 list.
- N** No grommet.

–Specify caster option as **11th digit** in product number.

- G** Glides
- C** Casters, add \$44 list.

- 2) Wood finish color.
- 3) Plastic laminate finish color (if specified).

# Tripoli by SMED

	Height	Depth	Width	Number	Wood Finish Group			
					1	2	3	4
<b>Cabinet</b>	29 1/2"(753mm)	24"(610mm)	32"(813mm)	TRMC-2432- <span style="display: inline-block; width: 10px; height: 10px; background-color: #ccc; border: 1px solid #000;"></span> <span style="display: inline-block; width: 10px; height: 10px; background-color: #ccc; border: 1px solid #000;"></span> <span style="display: inline-block; width: 10px; height: 10px; background-color: #ccc; border: 1px solid #000;"></span>	\$1397	\$1471	\$1545	\$1765

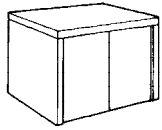

TRMC-2432-1NG

- Doors with concealed hinges.
- Full-height finished back with full length wireway access under top.
- One adjustable shelf.
- Adjustable glides or four casters (2 locking).
- Top available with wood veneer or plastic laminate.
- Height is the same with glides or casters.
- Edge detail on user side.

**To Order, Specify:**

- 1) Product number.
  - Specify edge detail as **9th digit** in product number.
    - 1** Square edge
    - 2** Bevel edge
    - 3** Chamfer edge
    - 4** Radius edge
  - Specify grommet option as **10th digit** in product number.
    - Y** Center, add \$83 list.
    - N** No grommet.
  - Specify caster option as **11th digit** in product number.
    - G** Glides
    - C** Casters, add \$44 list.
- 2) Wood finish color.
- 3) Plastic laminate finish color (if specified).

# Tripoli by SMED

	Height	Depth	Width	Application/Filing	Number	Wood Finish Group			
						1	2	3	4
<b>Box/Box/File Pedestal</b>	28 1/8"(715mm)	19 1/2"(495mm)	16 3/8"(415mm)	21 1/2"(546mm) / 24"(610mm)-deep desk shells, returns / letter width	TPF3-2017-	\$ 870	\$ 916	\$ 962	\$1099
			19"(481mm)	21 1/2"(546mm) / 24"(610mm)-deep desk shells, returns / legal width	TPF3-2019-	921	970	1019	1164
	28 1/8"(715mm)	23 7/16"(595mm)	16 3/8"(415mm)	30"(762mm) / 36"(914mm)-deep desk shells / letter width	TPF3-2417-	942	992	1042	1190
			19"(481mm)	30"(762mm) / 36"(914mm)-deep desk shells / legal width	TPF3-2419-	1013	1066	1119	1279

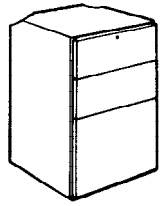

TPF3-S  
TPF3-W

- Standard with one front-mounted lock.
- Available with letter or legal front-to-back filing.
- Top and back will be unfinished.
- Mounting hardware included.
- One pencil tray included.
- For filing capacities, see page 45.
- Standard price includes modular/steel drawers.
- Letter width have modular plastic drawers.
- Legal width have steel drawers.

**To Order, Specify:**

- 1) Product number.  
–Specify interior drawer construction as **9th digit** in product number.  
**S** Modular/steel  
**W** Wood, add \$225 list.
- 2) Wood finish color.

<b>File/File Pedestal</b>	28 1/8"(715mm)	19 1/2"(495mm)	16 3/8"(415mm)	21 1/2"(546mm) / 24"(610mm)-deep desk shells, returns / letter width	TPF2-2017-	\$ 870	\$ 916	\$ 962	\$1099
			19"(481mm)	21 1/2"(546mm) / 24"(610mm)-deep desk shells, returns / legal width	TPF2-2019-	921	970	1019	1164
	28 1/8"(715mm)	23 7/16"(595mm)	16 3/8"(415mm)	30"(762mm) / 36"(914mm)-deep desk shells / letter width	TPF2-2417-	942	992	1042	1190
			19"(481mm)	30"(762mm) / 36"(914mm)-deep desk shells / legal width	TPF2-2419-	1013	1066	1119	1279

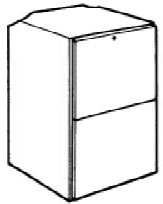

TPF2-S  
TPF2-W

- Standard with one front-mounted lock.
- Available with letter or legal front-to-back filing.
- Top and back will be unfinished.
- Mounting hardware included.
- For filing capacities, see page 45.
- Standard price includes steel drawers.

**To Order, Specify:**

- 1) Product number.  
–Specify interior drawer construction as **9th digit** in product number.  
**S** Steel  
**W** Wood, add \$225 list.
- 2) Wood finish color.

# Tripoli by SMED

	Height	Depth	Width	Application/Filing Number	Wood Finish Group			
					1	2	3	4

**Lateral File**

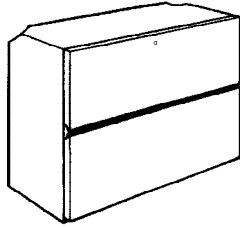

TPF5-S  
TPF5-W

28 1/8"(715mm)	19 1/2"(495mm)	30"(762mm)	TPF5-2030-	\$ 983	\$1035	\$1087	\$1242
		36"(914mm)	TPF5-2036-	\$1126	1185	1244	1422

- Standard with one front-mounted lock.
- Letter and legal filing in 36"(914mm) width, letter filing in 30"(762mm) width.
- Front-to-back filing bars provided.
- Top and back will be unfinished.
- Standard price includes steel drawers.
- Intended to be used under desk and credenza shells.

**To Order, Specify:**

- Product number.  
–Specify interior drawer construction as **9th digit** in product number.  
**S** Steel  
**W** Wood, add \$450 list.
- Wood finish color.

**Storage Compartment**

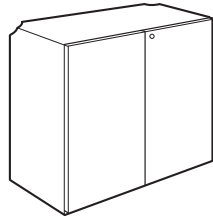

TPF6-K

28 1/8"(715mm)	19 1/2"(495mm)	30"(762mm)	TPF6-2030-	\$1013	\$1066	\$1119	\$1279
		36"(914mm)	TPF6-2036-	\$1085	1142	1199	1370

- Two doors with one adjustable shelf.
- Top and back will be unfinished.
- Intended to be used under desk and credenza shells.

**To Order, Specify:**

- Product number.  
–Specify door lock option as **9th digit** in product number.  
**N** No lock  
**K** Lock, add \$150 list.
- Wood finish color.

**Pedestal Filler**

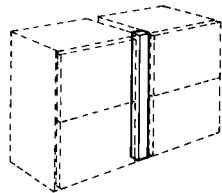

LPFF-127

27 3/4"(707mm)	1 1/2"(38mm)	1 15/32"(813mm)	28 1/8"(715mm)- high pedestals	LPFF-127	\$65
----------------	--------------	-----------------	-----------------------------------	----------	------

- Wood filler mounts to sides of pedestals.
- Permits access to the drawer pull vertical reveals when pedestals are situated side-by-side with another pedestal, lateral file, or storage compartment.

**To Order, Specify:**

- Product number.
- Wood finish color.

**Mobile Pedestal**

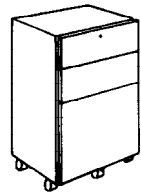

TPM3-20-S  
TPM3-20-W

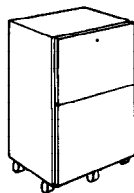

TPM1-20-S  
TPM1-20-W

27 7/8"(708mm)	19 11/16"(500mm)	16 3/8"(415mm)	Box/box/file	TPM3-20-	\$1315	\$1384	\$1453	\$1661
			File/file	TPM1-20-	1328	1398	1468	1678

- Casters.
- Finished sides, top and back.
- Standard with one front-mounted lock.
- Standard price includes modular/steel drawers.

**To Order, Specify:**

- Product number.  
–Specify interior drawer construction as **7th digit** in product number.  
**S** Modular/steel  
**W** Wood, add \$225 list.
- Wood finish color.

# Tripoli by SMED

	Height	Depth	Width	Number	Wood Finish Group			
					1	2	3	4
<b>Two-High Lateral File</b>	29 1/2"(753mm)	21 1/2"(546mm)	31"(787mm)	TRLF-231- ■ ■	<b>\$1078</b>	<b>\$1135</b>	<b>\$1192</b>	<b>\$1362</b>
			37"(940mm)	TRLF-237- ■ ■	<b>1221</b>	<b>1285</b>	<b>1349</b>	<b>1542</b>

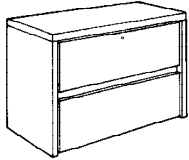

TRLF-237-1

- Two drawers with one front-mounted lock.
- Letter or legal lateral filing.
- Front-to-back filing bars provided.
- Anti-tilt mechanism.
- Top available with wood veneer or plastic laminate.
- Shipped assembled.
- Standard price includes steel drawers.
- Edge detail on user side.

### To Order, Specify:

- 1) Product number.  
–Specify edge detail as **8th digit** in product number.
  - 1** Square edge
  - 2** Bevel edge
  - 3** Chamfer edge
  - 4** Radius edge
 –Specify interior drawer construction as **9th digit** in product number.
  - S** Steel
  - W** Wood, add \$450 list.
- 2) Wood finish color.
- 3) Plastic laminate finish color (if specified).

<b>Three-High Lateral File</b>	42 1/2"(1078mm)	21 1/2"(546mm)	31"(787mm)	TRLF-331- ■ ■	<b>\$1700</b>	<b>\$1790</b>	<b>\$1880</b>	<b>\$2148</b>
			37"(940mm)	TRLF-337- ■ ■	<b>1890</b>	<b>1990</b>	<b>2090</b>	<b>2388</b>

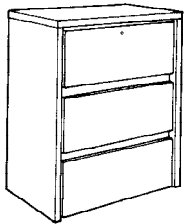

TRLF-331

- Three drawers with one front-mounted lock.
- Letter or legal filing.
- Front-to-back filing bars provided.
- Anti-tilt mechanism.
- Shipped assembled.
- Standard price includes steel drawers.
- Edge detail on user side.

### To Order, Specify:

- 1) Product number.  
–Specify edge detail as **8th digit** in product number.
  - 1** Square edge
  - 2** Bevel edge
  - 3** Chamfer edge
  - 4** Radius edge
 –Specify interior drawer construction as **9th digit** in product number.
  - S** Steel
  - W** Wood, add \$675 list.
- 2) Wood finish color.

<b>Four-High Lateral File</b>	55 3/8"(1408mm)	21 1/2"(546mm)	31"(787mm)	TRLF-431- ■ ■	<b>\$2213</b>	<b>\$2329</b>	<b>\$2445</b>	<b>\$2795</b>
			37"(940mm)	TRLF-437- ■ ■	<b>2450</b>	<b>2579</b>	<b>2708</b>	<b>3095</b>

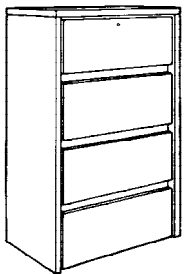

TRLF-431

- Four drawers with one front-mounted lock.
- Letter filing.
- Front-to-back filing bars provided.
- Anti-tilt mechanism.
- Shipped assembled.
- Standard price includes steel drawers.
- Edge detail on user side.

### To Order, Specify:

- 1) Product number.  
–Specify edge detail as **8th digit** in product number.
  - 1** Square edge
  - 2** Bevel edge
  - 3** Chamfer edge
  - 4** Radius edge
 –Specify interior drawer construction as **9th digit** in product number.
  - S** Steel
  - W** Wood, add \$900 list.
- 2) Wood finish color.



# Tripoli by SMED

	Height	Depth	Width	Number	Wood Finish Group			
					1	2	3	4
<b>Two-High Lateral File with Storage Compartment</b>	64"(1626mm)	24"(610mm)	31"(787mm)	TRLS-231- <input type="checkbox"/> <input type="checkbox"/>	<b>\$2930</b>	<b>\$3084</b>	<b>\$3238</b>	<b>\$3701</b>
			37"(940mm)	TRLS-237- <input type="checkbox"/> <input type="checkbox"/>	<b>3244</b>	<b>3415</b>	<b>3586</b>	<b>4098</b>

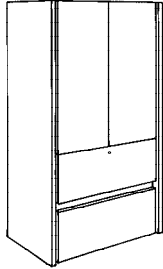

TRLS-231

- Two lateral drawers with one front-mounted lock.
- One shelf adjustable:  
21 1/8"(537mm) deep x 28 1/2"(724mm) wide.
- Shelf adjusts in 26 positions at 1 1/4"(32mm) spacing.
- Letter filing.
- Front-to-back filing bars provided.
- Anti-tilt mechanism.
- Standard price includes steel drawers.

**To Order, Specify:**

- 1) Product number.  
-Specify interior drawer construction as **8th digit** in product number.  
**S** Steel  
**W** Wood, add \$450 list.  
-Specify door lock option as **9th digit** in product number.  
**N** No lock  
**K** Lock, add \$150 list.
- 2) Wood finish color.

<b>Three-High Lateral File with Storage Compartment</b>	64"(1626mm)	24"(610mm)	31"(787mm)	TRLS-331- <input type="checkbox"/> <input type="checkbox"/>	<b>\$2942</b>	<b>\$3097</b>	<b>\$3252</b>	<b>\$3716</b>
			37"(940mm)	TRLS-337- <input type="checkbox"/> <input type="checkbox"/>	<b>3257</b>	<b>3428</b>	<b>3599</b>	<b>4114</b>

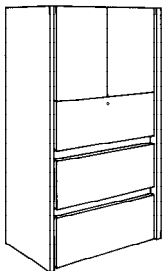

TRLS-331

- Three drawers with one front-mounted lock.
- Without shelves or shelf holes.
- Letter filing.
- Front-to-back filing bars provided.
- Anti-tilt mechanism.
- Standard price includes steel drawers.

**To Order, Specify:**

- 1) Product number.  
-Specify interior drawer construction as **8th digit** in product number.  
**S** Steel  
**W** Wood, add \$675 list.  
-Specify door lock option as **9th digit** in product number.  
**N** No lock  
**K** Lock, add \$150 list.
- 2) Wood finish color.

# Tripoli by SMED

	Height	Depth	Width	Description	Number	Wood Finish Group			
						1	2	3	4
<b>Two-High Bookcase</b>	29 1/2"(753mm)	14"(356mm)	36"(914mm)		TRBC-2936- SN	\$ 894	\$ 941	\$ 988	\$1129
				With doors	TRBC-2936- F	1224	1271	1318	1459

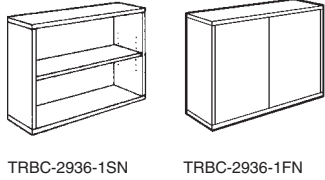

- One adjustable shelf, see page 75 for additional shelf.
- Includes glides.
- Top available with wood veneer or plastic laminate.

**To Order, Specify:**

- 1) Product number.  
 -Specify edge detail as **9th digit** in product number.
  - 1** Square edge
  - 2** Bevel edge
  - 3** Chamfer edge
  - 4** Radius edge
 -Specify door lock option as **11th digit** in product number.
  - N** No lock
  - K** Lock, add \$150 list.
- 2) Wood finish color.
- 3) Plastic laminate finish color (if specified).

	Height	Depth	Width	Description	Number	Wood Finish Group			
						1	2	3	4
<b>Four-High Bookcase</b>	48"(1219mm)	14"(356mm)	36"(914mm)		TRBC-4836- SN	\$1183	\$1245	\$1307	\$1494
				With half doors	TRBC-4836- F	1513	1575	1637	1824

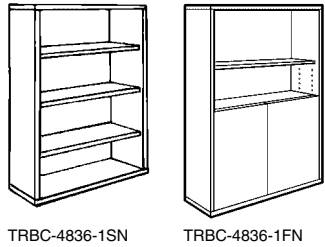

- Three adjustable shelves, see page 75 for additional shelf.
- Includes glides.
- Top edge of doorset height - 28"(710mm).
- Edge detail on top.
- Shelves are fully adjustable.

**To Order, Specify:**

- 1) Product number.  
 -Specify edge detail as **9th digit** in product number.
  - 1** Square edge
  - 2** Bevel edge
  - 3** Chamfer edge
  - 4** Radius edge
 -Specify door lock option as **11th digit** in product number.
  - N** No lock
  - K** Lock, add \$150 list.
- 2) Wood finish color.

# Tripoli by SMED

	Height	Depth	Width	Description	Number	Wood Finish Group			
						1	2	3	4
<b>Five-High Bookcase</b>	64"(1626mm)	14"(356mm)	36"(914mm)		TRBC-6436- SN	\$1471	\$1548	\$1625	\$1858
				With half doors	TRBC-6436- F	\$1801	1878	1955	2188

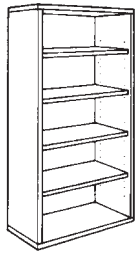

TRBC-6436-1SN

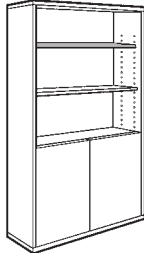

TRBC-6436-1FN

- Four adjustable shelves, see below for additional shelf.
- Includes glides.
- Top edge of doorset height - 28"(710mm).
- Shelves are fully adjustable.

**To Order, Specify:**

- 1) Product number.  
 -Specify edge detail as **9th digit** in product number.
  - 1** Square edge
  - 2** Bevel edge
  - 3** Chamfer edge
  - 4** Radius edge
 -Specify door lock option as **11th digit** in product number.
  - N** No lock
  - K** Lock, add \$150 list.
- 2) Wood finish color.

	Height	Depth	Width	Description	Number	Price
<b>Shelf</b>	3/4"(19mm)	12"(305mm)	33 7/16"(849mm)		LSTR-36	\$121

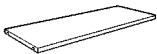

LSTR-36

- Additional shelf for Tripoli bookcases.

**To Order, Specify:**

- 1) Product number
- 2) Wood finish color

# Tripoli by SMED

	Height	Depth	Width	Number	Wood Finish Group			
					1	2	3	4

**64"(1626mm) Storage Cabinet**

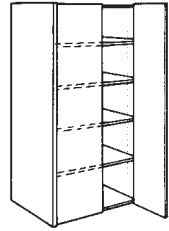

TRS-6432-N

64"(1626mm)	24"(610mm)	32 1/2"(826mm)	TRS-6432-	\$2511	\$2643	\$2775	\$3172
-------------	------------	----------------	-----------	--------	--------	--------	--------

- Finished back panel.
- Four adjustable shelves.
- Doors with concealed hinges.

**To Order, Specify:**

- 1) Product number.  
 -Specify door lock option as **8th digit** in product number.  
 **N** No lock  
 **K** Lock, add \$150 list.
- 2) Wood finish color.

**64"(1626mm) Wardrobe/Storage Cabinet**

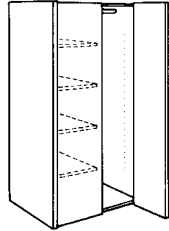

TRWS-6432-N

64"(1626mm)	24"(610mm)	32 1/2"(826mm)	TRWS-6432-	\$2737	\$2881	\$3025	\$3457
-------------	------------	----------------	------------	--------	--------	--------	--------

- Finished back panel.
- Wardrobe carrier.
- Center partition.
- Four adjustable shelves.
- Doors with concealed hinges.

**To Order, Specify:**

- 1) Product number.  
 -Specify door lock option as **9th digit** in product number.  
 **N** No lock  
 **K** Lock, add \$150 list.
- 2) Wood finish color.

**64"(1626mm) Wardrobe Cabinet**

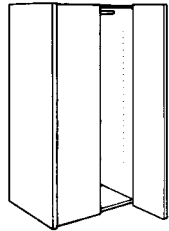

TRW-6432-N

64"(1626mm)	24"(610mm)	32 1/2"(826mm)	TRW-6432-	\$2363	\$2487	\$2611	\$2984
-------------	------------	----------------	-----------	--------	--------	--------	--------

- Finished back panel.
- Wardrobe carrier.
- Doors with concealed hinges.

**To Order, Specify:**

- 1) Product number.  
 -Specify door lock option as **8th digit** in product number.  
 **N** No lock  
 **K** Lock, add \$150 list.
- 2) Wood finish color.

# Tripoli by SMED

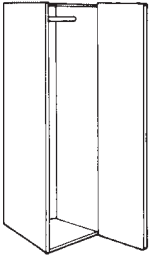
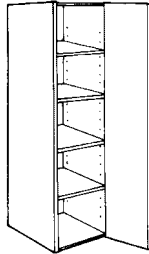
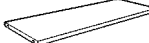
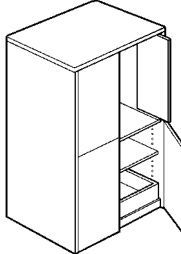
	Height	Depth	Width	Number	Wood Finish Group			
					1	2	3	4
<b>64" (1626mm) Individual Wardrobe Cabinet</b>  TRW-6418-NR (Right shown)	64"(1626mm)	24"(610mm)	18"(457mm)	TRW-6418-■ ■	\$2218	\$2335	\$2452	\$2802
<ul style="list-style-type: none"> <li>Finished back panel.</li> <li>Wardrobe carrier.</li> <li>Single door.</li> </ul>	<b>To Order, Specify:</b> 1) Product number. –Specify door lock option as <b>8th digit</b> in product number. ■ <b>N</b> No lock ■ <b>K</b> Lock, add \$150 list. –Specify cabinet orientation as <b>9th digit</b> in product number. ■ <b>L</b> Left-handed ■ <b>R</b> Right-handed 2) Wood finish color.							
<b>64" (1626mm) Individual Storage Cabinet</b>  TRS-6418-NR (Right shown)	64"(1626mm)	24"(610mm)	18"(457mm)	TRS-6418-■ ■	\$2358	\$2482	\$2606	\$2978
<ul style="list-style-type: none"> <li>Finished back panel.</li> <li>Four adjustable shelves.</li> <li>Single door.</li> </ul>	<b>To Order, Specify:</b> 1) Product number. –Specify door lock option as <b>8th digit</b> in product number. ■ <b>N</b> No lock ■ <b>K</b> Lock, add \$150 list. –Specify cabinet orientation as <b>9th digit</b> in product number. ■ <b>L</b> Left-handed ■ <b>R</b> Right-handed 2) Wood finish color.							
<b>Shelf</b>  LS-14 LS-30	3/4"(19mm)	21 1/8"(537mm)	14 5/16"(357mm)	Additional adjustable shelf (wardrobe/storage only).	LS-14	\$110		
	3/4"(19mm)	21 1/8"(537mm)	29 7/16"(748mm)	Additional adjustable shelf (storage only).	LS-30	\$110		
<ul style="list-style-type: none"> <li>Additional shelf for Tripoli wardrobe and storage cabinets, see above.</li> </ul>	<b>To Order, Specify:</b> 1) Product number 2) Wood finish color.							
<b>Video Cabinet</b>  TRVC-7236-N	72"(1829mm)	28"(711mm)	36"(914mm)	TRVC-7236-■	\$4146	\$4364	\$4582	\$5237
<ul style="list-style-type: none"> <li>TV pull-out shelf included.</li> <li>One shelf included in storage area.</li> <li>TV opening is 29 1/8" (740mm) wide, 36 1/2" (927mm) high, 27 1/8" (689mm) deep.</li> <li>VCR tape holder included.</li> <li>Inside dimensions of VCR tape holder are 3 3/8" (86mm) high x 24 7/8" (632mm) deep x 28" (711mm) wide.</li> <li>Access hole provided in back of unit to route cords.</li> <li>Lower doors available with or without locks.</li> </ul>	<b>To Order, Specify:</b> 1) Product number –Specify door lock option as <b>9th digit</b> in product number. ■ <b>N</b> No lock ■ <b>K</b> Lock, add \$150 list. 2) Wood finish color.							

# Tripoli by SMED

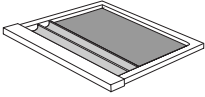
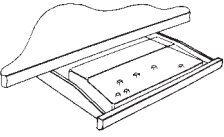
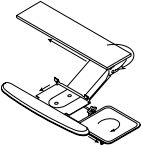
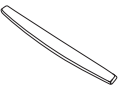
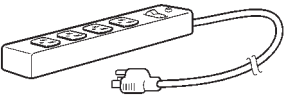
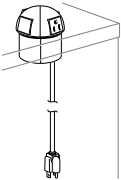
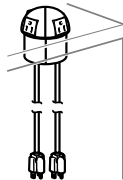
	Height	Depth	Width	Number	Price
<b>Center Drawer</b>  YRCD-1 Class RB	1"(25mm)	18"(457mm)	23"(584mm)	YRCD-1	\$198
<ul style="list-style-type: none"> <li>• Non-locking drawer.</li> <li>• Requires field installation.</li> </ul>	<b>To Order, Specify:</b> 1) Product number. 2) Wood finish color.				
<b>Keyboard Pullout Tray</b>  L-KT Class RA	3 3/16"(81mm)	18 7/8"(479mm)	22 1/2"(572mm)	L-KT	\$356
<ul style="list-style-type: none"> <li>• Accommodates up to a 10"(254mm) deep x 20 1/4"(514mm) wide x 2 1/2"(64mm) high keyboard.</li> <li>• Solid wood frame with charcoal bottom.</li> </ul>	<b>To Order, Specify:</b> 1) Product number. 2) Wood finish color.				
<b>Adjustable Keyboard Pad</b>  L-AKP-3 Class RA	3 1/2"(89mm)	5 3/4"-9"(146mm-229mm)	17"-22"(432mm-559mm)	L-AKP-3	\$450
<ul style="list-style-type: none"> <li>• Includes adjustable keyboard pad and palm rest.</li> <li>• Spring assisted mechanism tilts, raises, lowers and has dual swivel complete with adjustable palm rest.</li> <li>• Mouse pad swivels, tilts, and is interchangeable between right and left hand applications.</li> </ul>	<b>To Order, Specify:</b> 1) Product number. (No finish specification required.)				
<b>Wrist Support</b>  L-LPR-2 Class RA	1"(25mm)	2 1/2"(64mm)	27 3/4"(705mm)	L-LPR-2	\$ 89
<ul style="list-style-type: none"> <li>• Gel interior.</li> <li>• Standard in black finish color only.</li> <li>• Covers keyboard and mouse area.</li> </ul>	<b>To Order, Specify:</b> 1) Product number. (No finish specification required.)				
<b>Convenience Outlet Strip</b>  L-COS Class RA				L-COS	\$172
<ul style="list-style-type: none"> <li>• Requires field installation.</li> <li>• Cord length is 67"(1702mm).</li> </ul>	<b>To Order, Specify:</b> 1) Product number. (No finish specification required.)				
<b>Power Domes</b>  OLTD-2 Class RA					
 OLTD-4					
<b>Description</b> Two (2) power outlets and two (2) plates for data connections Four (4) power outlets				<b>Number</b> OLTD-2 OLTD-4	<b>Price</b> \$144 158
<ul style="list-style-type: none"> <li>• Provides power and communication access at desk top height.</li> <li>• Mounts into a field-cut 3"(76mm) diameter hole.</li> <li>• Standard in black finish color only.</li> <li>• OLTD-2 accepts category 3 connection hardware.</li> <li>• OLTD-2 includes one (1) 72"(1829mm) long power cord and 15-amp plug. OLTD-4 includes two (2) 72"(1829mm) long power cords and 15-amp plugs.</li> <li>• Requires field installation.</li> </ul>	<b>To Order, Specify:</b> 1) Product number. (No finish specification required.)				

# Tripoli by SMED

	Height	Depth	Width	Number	Price
<b>Wire Channel</b>			48"(1219mm)	L-WMT	\$37



L-WMT  
Class RA

- Specify for use with desks, kneespace credenzas and desk extensions.
- Requires field installation.

**To Order, Specify:**  
1) Product number.  
(No finish specification required.)

	Height	Hole Size	Width	Number	Price
<b>Grommet</b>	1"(25mm)	3"(76mm)	3"(76mm)	YSG-1	\$11

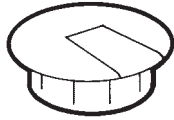

YSG-1  
Class RB

- Requires field installation.
- Standard in black finish color only.

**To Order, Specify:**  
1) Product number.  
(No finish specification required.)

<b>16 1/2" Pedestal Drawer Accessories</b>	Description	Number	Price
	pedestal pencil tray	YAPP-16	\$ 9
	pedestal rubber stamp holder	YAPH-16	23
	pedestal drawer divider	YAPV-16	12
	pedestal single disc bin	YAPS-16	23
	single disc bin divider	YASD-16	5
	single disc bin kit (includes 1 bin and 14 dividers)	YASK-16	95
	pedestal double disc bin	YAPD-16	29
	double disc bin divider	YADS-16	6
	double disc bin kit (includes 14 dividers)	YADK-16	114
	pedestal form tray - 1 tray	YAPF-1601	11
pedestal form tray - 4 trays	YAPF-1604	42	
pedestal form tray - 6 trays	YAPF-1606	64	

YAPP-16  
Class RB

- Black trim color.
- Accessories for letter width modular box drawers.

**To Order, Specify:**  
1) Product number  
(No finish specification required.)

<b>Lateral File Accessories</b>	Description	Number	Price
	15" deep lateral file front to back hanging bar	YALF-15	\$15
	30" wide lateral file side to side steel hanging bar	TALS-30	23
	36" wide lateral file side to side steel hanging bar	TALS-36	23
	30" wide lateral file side to side wood hanging bar	TALW-30	23
	36" wide lateral file side to side wood hanging bar	TALW-36	23

YALF-15  
Class RB

- Black trim color.

**To Order, Specify:**  
1) Product number  
(No finish specification required.)

# Tripoli by SMED

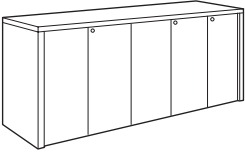
	Height	Depth	Width	Number	Wood Finish Group			
					1	2	3	4
<b>Conference Buffet</b>	<b>Wood/Laminate Top</b>							
	36"(914mm)	18"(457mm)	72"(1829mm)	CACB-1873-	\$4540	\$4779	\$5018	\$5735
	<b>Metal Inlay</b>							
	36"(914mm)	18"(457mm)	72"(1829mm)	CACB-1873-	5113	5352	5591	6308
CACB-1873	<ul style="list-style-type: none"> <li>Wood veneer, plastic laminate, or etched metal top (1 1/2"(38mm) thick).</li> <li>Wood end panels (1 1/4"(32mm) thick).</li> <li>Three compartments with one adjustable shelf each.</li> <li>Right compartment with 18"(457mm)-wide pencil drawer.</li> <li>Finished wood back.</li> <li>Adjustable glides.</li> </ul>				<b>To Order, Specify:</b> <ol style="list-style-type: none"> <li>Product number.                             <ul style="list-style-type: none"> <li>Specify edge detail as <b>9th digit</b> in product number.                                     <ul style="list-style-type: none"> <li><b>1</b> Square edge</li> <li><b>2</b> Bevel edge</li> <li><b>3</b> Chamfer edge</li> <li><b>4</b> Radius edge</li> </ul> </li> <li>Specify door lock option as <b>10th digit</b> in product number.                                     <ul style="list-style-type: none"> <li><b>N</b> No lock</li> <li><b>K</b> Lock, add \$450 list for three locks.</li> </ul> </li> </ul> </li> <li>Wood finish color.</li> <li>Plastic laminate or etched metal inlay finish color (if specified).</li> </ol>			

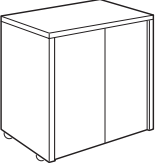
	Height	Depth	Width	Number	Wood Finish Group			
					1	2	3	4
<b>Conference Caddy</b>	<b>Wood/Laminate Top</b>							
	27"(686mm)	18"(457mm)	30 3/8"(772mm)	CACC-1830-	\$1804	\$1899	\$1994	\$2279
	<b>Metal Inlay</b>							
	27"(686mm)	18"(457mm)	30 3/8"(772mm)	CACC-1830-	2032	2127	2260	2507
CACC-1830	<ul style="list-style-type: none"> <li>Wood veneer, plastic laminate, or etched metal top (1 1/2"(38mm) thick).</li> <li>Wood end panels (1 1/4"(32mm) thick).</li> <li>One compartment with adjustable shelf.</li> <li>Finished wood back.</li> <li>Hidden casters.</li> </ul>				<b>To Order, Specify:</b> <ol style="list-style-type: none"> <li>Product number.                             <ul style="list-style-type: none"> <li>Specify edge detail as <b>9th digit</b> in product number.                                     <ul style="list-style-type: none"> <li><b>1</b> Square edge</li> <li><b>2</b> Bevel edge</li> <li><b>3</b> Chamfer edge</li> <li><b>4</b> Radius edge</li> </ul> </li> <li>Specify door lock option as <b>10th digit</b> in product number.                                     <ul style="list-style-type: none"> <li><b>N</b> No lock</li> <li><b>K</b> Lock, add \$150 list.</li> </ul> </li> </ul> </li> <li>Wood finish color.</li> <li>Plastic laminate or etched metal inlay finish color (if specified).</li> </ol>			



# Tripoli by SMED

	Height	Depth	Width	Number	Wood Finish Group	Fabric Grade		
						A	B	C
<b>Presentation Board</b>	48"(1219mm)	5 1/4"(133mm)	48"(1219mm)	YAVD-4848-W	1	\$2029	\$2041	\$2057
				YAVD-4848-W	2	2163	2175	2191
				YAVD-4848-W	3	2297	2309	2325
				YAVD-4848-W	4	2698	2710	2726
<b>Etched Metal Inlay</b>								
	48"(1219mm)	5 1/4"(133mm)	48"(1219mm)	YAVD-4848-W	1	\$2429	\$2441	\$2457
				YAVD-4848-W	2	2563	2575	2591
				YAVD-4848-W	3	2697	2709	2725
				YAVD-4848-W	4	3098	3110	3126

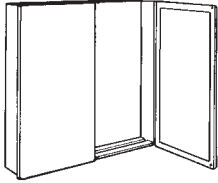

YAVD-4848-W

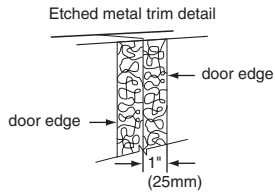

- Erasable writing surface on inside back panel (marker and eraser not included).
- Fabric covered tackboards are glued in place on each door.
- Standard with flip chart (mounted over tackboard) convertible left or right.
- COM yardage: 2.5.
- Wall mounting hardware included.
- Available with or without projection screen.

- Erasable writing surface (marker and eraser not included).
- Available with wood or etched metal trim.
- Wall mounting hardware included.
- COM yardage: 2.5.
- Tackboards are glued in place.

**To Order, Specify:**

- 1) Product number.  
 –Specify projection screen or flip chart, if desired, as **10th digit** in product number.  
N No projection screen  
S Projection screen, add \$183 list.
- 2) Wood finish color.
- 3) Tackboard fabric surface and color.
- 4) Etched metal inlay finish color (if specified).



# PLACES

<b>Product Offering</b>	The PLACES wood casegoods product offering consists of the following:		
	Table Desks	Bridges	Pedestals
	Desk Shells	Credenza Cases	Undersurface Lateral Files
	Single Pedestal Desks	Credenzas	Bookcases
	Double Pedestal Desks	90° Corners	Wardrobe Units
	Return Cases	Convergenents	Storage Units
	Returns	Vertical Storage Units	Lateral Files

**Construction Features**

**Top and Base Construction**

All 29"(610mm) -high wood casegoods are available with a 1 9/16"(40mm) -thick standard top for freestanding applications.

Tops are constructed of a 1 1/2"(38mm) -thick 45lb. particle board core with a 7/16"(11mm) -thick solid wood edge banding and a .6mm- to .7mm-thick veneer face.

Desk, credenza and return end panels are constructed of a 1 1/2"(38mm) -thick 45lb. particle board core with a 7/16"(11mm) - thick solid edge banding and a .6mm- to .7mm-thick veneer face on two sides. Desk and credenza modesty panels are constructed of a 3/4"(19mm) -thick 45lb. particle board core with a .6mm- to .7mm- thick veneer face on two sides. Return and bridge modesty panels are constructed of a 1"(25mm) -thick 45lb. particle board core with a 7/16"(11mm) -thick edge banding and a .6mm to .7mm -thick veneer face on two sides.

Bookcase, lateral file and wardrobe end panels are constructed of a 1"(25mm) -thick 45lb. particle board core with a 7/16"(11mm) -thick solid edge banding and a .6mm- to .7mm -thick veneer face on two sides.

Bookcase, lateral file, wardrobe and vertical storage unit back panels are constructed of a 1/2"(13mm) -thick 45lb. particle board core with a .6mm to .7mm-thick veneer face on two sides.

**Pedestals**

Pedestal drawer boxes are constructed of medium density, particle board panels wrapped with wood grained vinyl. Drawer boxes are tough, durable and washable. They are made of recycled material and pass all BIFMA tests. Drawer fronts are constructed of 3/4"(19mm) -thick 45lb. particle board and faced with veneer.

An integrated vertical finger pull is standard on all pedestal case sides.

File and lateral drawers feature full-extension steel ball bearing slides. Box and pencil drawers feature 3/4-extension steel ball bearing slides.

**Filing Capacities**

Standard-width 24"(610mm) deep desk file drawers accommodate one row of letter size files placed front-to-back, one row of letter size files placed side-to-side, or one row of legal size files placed side-to-side. Legal-width 24"(610mm) deep desk file drawers accommodate one row of legal size files placed front-to-back, one row of letter size files placed side-to-side, or one row of legal size files placed side-to-side.

Lateral file drawers accommodate letter or legal size files placed side-to-side.

The lineal inches of file capacity per file drawer are as follows:

<b>Drawer Width/Depth Standard/24"(610mm)</b>	<b>Front-to-Back 19 1/2"(495mm)</b>	<b>Side-to-Side 12"(305mm)</b>
Legal/24"(610mm)	19 1/2"(495mm)	15"(381mm)
Lateral 30"(762mm)	15 9/16"(396mm)	25 5/8"(651mm)
Lateral 36"(914mm)	15 9/16"(396mm)	31 5/8"(803mm)

**Lock Programs**

Desks, returns and credenzas with pedestals, wardrobe/storage units, and lateral files each feature one or more locks. Vertical storage units with flipper doors are available with or without locks. Locks will be randomly keyed unless specified keyed-alike or master keyed.

All locks will have a standard matte black finish regardless of veneer type or wood finish color.

Refer to the current Lock Programs Specification Guidelines Price List for ordering instructions and master keying price. Contact the Haworth Order Services Inquiry Center for more information.

**Edge Detail**

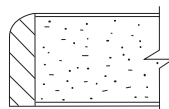

# PLACES

## Wood/Finish Features

PLACES wood casegoods are constructed of one of the following veneer and solids options: cherry veneer with cherry solids, maple veneer with maple solids, anegre veneer with maple solids, or double cut veneer with double cut solids.

Veneer grain for double cut veneers is laid up horizontally on casegood drawer and door fronts. Veneer grain for natural veneers is laid up vertically on casegood drawer and door fronts.

All cherry veneers are plain-sliced and book-matched; all exposed maple veneers are half-round cut and book-matched; all exposed anegre veneers are quarter cut and slip-matched; and all exposed double cut veneers are rift cut.

All PLACES wood casegoods are finished with layers of catalyzed lacquer to develop a thoroughly sealed, low-maintenance finish. Writing surfaces are finished with tough and environmentally friendly UV cured material for long lasting beauty. To keep your wood writing surfaces looking beautiful for the life of the product, it is highly recommended that a blotter pad, glass or plexiglass surface be used under writing instruments.

## General Guidelines for Product Specification

PLACES wood casegood product specification numbers are based on an alpha-numeric logic that identifies a product by product line, size, and certain characteristics.

For example, a product number that reads **WDF2-3672-HJ, VP-N** identifies the product as a wood desk with full-height modesty panel and a systems top thickness, 36"(914mm) -wide by 72"(1829mm) -deep, and having 6"/6"/12"(152mm/152mm/305mm) and 12"/12"(305mm/305mm) pedestals.

The alpha-numeric logic for this product complete with wood finish color code is shown below:

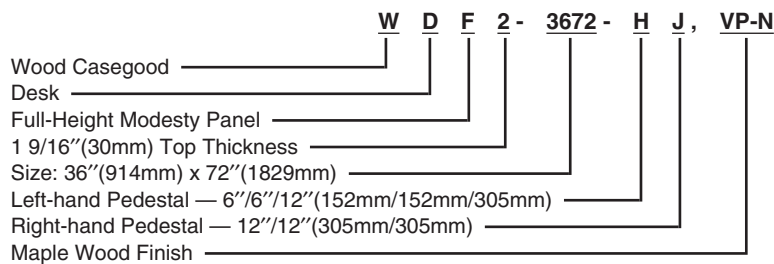

There are exceptions to this logic; therefore, always refer to the price charts for product numbers rather than attempting to construct them. Product number modification instructions for additional options appear in footnoted copy for each applicable product.

Beyond the printed product number, a wood finish code is required to complete an order specification. Select products also require a fabric finish code. To communicate your order clearly, list the product number and finish code in the sequence outlined on each page of the price list.

## Finishes and Fabrics

A complete listing of finishes and fabrics for PLACES wood casegoods can be found on pages 207-211.

# PLACES

	Height	Depth	Width	Number	Wood Finish Group	
					I	II
<b>Table Desks</b>	29"(737mm)	36"(914mm)	72"(1829mm)	WDT2-3672	\$2298	\$2482

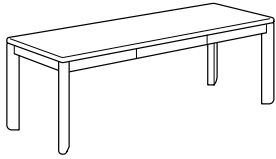

WDT2

- Veneer top surface with solid wood edge.
- Legs are solid oak with veneer wrap.
- One adjustable glide per leg.
- 30"(762mm)-wide pencil drawer in 3"(76mm) table apron.
- Cannot be attached to bridges or returns.
- Unit shipped unassembled.

**To Order, Specify:**

- 1) Product number.
- 2) Wood finish color.

# PLACES

**Desk Shell — Full-Height Modesty Panel**

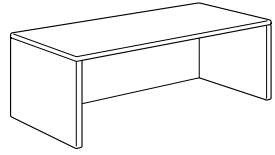

WDF2

	Height	Depth	Width	Number	Wood Finish Group	
					I	II
	29"(737mm)	30"(762mm)	60"(1524mm)	WDF2-3060	\$1735	\$1891
			66"(1676mm)	WDF2-3066	1811	1974
			72"(1829mm)	WDF2-3072	1934	2107
		36"(914mm)	66"(1676mm)	WDF2-3666	\$1934	\$2107
			72"(1829mm)	WDF2-3672	2089	2276

- Wood veneer top with solid wood edge trim.
- Accepts optional pedestals, see pages 99-101.

**To Order, Specify:**

- 1) Product number.
- 2) Wood finish color.

# PLACES

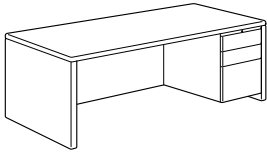
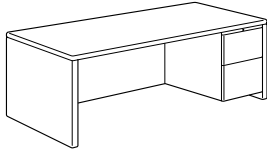
	Height	Depth	Width	Drawer Stack Location	Number	Wood Finish Group I	Wood Finish Group II	
 WDF2-H (Right-hand shown)	29" (737mm)	30" (762mm)	60" (1524mm)	6"/6"/12" right	WDF2-3060-H	\$2606	\$2839	
				6"/6"/12" left	WDF2-3060-HL	2606	2839	
					12"/12" right	WDF2-3060-J	2606	2839
					12"/12" left	WDF2-3060-JL	2606	2839
			66" (1676mm)	6"/6"/12" right	WDF2-3066-H	\$2682	\$2922	
				6"/6"/12" left	WDF2-3066-HL	2682	2922	
				12"/12" right	WDF2-3066-J	2682	2922	
				12"/12" left	WDF2-3066-JL	2682	2922	
			72" (1829mm)	6"/6"/12" right	WDF2-3072-H	\$2805	\$3055	
				6"/6"/12" left	WDF2-3072-HL	2805	3055	
 WDF2-J (Right-hand shown)	29" (737mm)	36" (914mm)	66" (1676mm)	6"/6"/12" right	WDF2-3666-H	\$2805	\$3055	
				6"/6"/12" left	WDF2-3666-HL	2805	3055	
					12"/12" right	WDF2-3666-J	2805	3055
					12"/12" left	WDF2-3666-JL	2805	3055
			72" (1829mm)	6"/6"/12" right	WDF2-3672-H	\$2960	\$3224	
				6"/6"/12" left	WDF2-3672-HL	2960	3224	
				12"/12" right	WDF2-3672-J	2960	3224	
				12"/12" left	WDF2-3672-JL	2960	3224	

- Wood veneer top with solid wood edge trim.
- Available with a 6"/6"/12" (152mm/152mm/305mm) pedestal, or a 12"/12" (305mm/305mm) pedestal.
- All pedestals are shipped with lock shells; lock plugs are field installed. Multiple locking units have random key numbers unless specified keyed-alike.

**To Order, Specify:**

- 1) Product number.
- 2) Wood finish color.

# PLACES

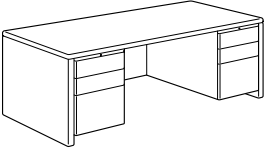
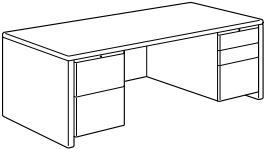
	Height	Depth	Width	Drawer Stack Location	Number	Wood Finish Group I	Wood Finish Group II		
<b>Double Pedestal Desk — Full-Height Modesty Panel</b>   WDF2-HH	29" (737mm)	30" (762mm)	60" (1524mm)	6"/6"/12" left	WDF2-3060-HH	\$3451	\$3759		
				6"/6"/12" right					
					6"/6"/12" left	WDF2-3060-HJ	3451	3759	
					12"/12" right				
					12"/12" left	WDF2-3060-JH	3451	3759	
					6"/6"/12" right				
			66" (1676mm)		6"/6"/12" left	WDF2-3066-HH	\$3572	\$3892	
					6"/6"/12" right				
					6"/6"/12" left	WDF2-3066-HJ	3572	3892	
					12"/12" right				
				12"/12" left	WDF2-3066-JH	3572	3892		
				6"/6"/12" right					
			72" (1829mm)		6"/6"/12" left	WDF2-3072-HH	\$3739	\$4074	
				6"/6"/12" right					
				6"/6"/12" left	WDF2-3072-HJ	3739	4074		
				12"/12" right					
				12"/12" left	WDF2-3072-JH	3739	4074		
				6"/6"/12" right					
 WDF2-HJ	29" (737mm)	36" (914mm)	66" (1676mm)	6"/6"/12" left	WDF2-3666-HH	\$3739	\$4074		
				6"/6"/12" right					
					6"/6"/12" left	WDF2-3666-HJ	3739	4074	
					12"/12" right				
					12"/12" left	WDF2-3666-JH	3739	4074	
					6"/6"/12" right				
				72" (1829mm)		6"/6"/12" left	WDF2-3672-HH	\$3942	\$4293
					6"/6"/12" right				
					6"/6"/12" left	WDF2-3672-HJ	3942	4293	
					12"/12" right				
				12"/12" left	WDF2-3672-JH	3942	4293		
				6"/6"/12" right					

- Wood veneer top with solid wood edge trim.
- Available with 6"/6"/12"(152mm/152mm/305mm) and 12"/12"(305mm/305mm) pedestals.
- All pedestals are shipped with lock shells; lock plugs are field installed. Multiple locking units have random key numbers unless specified keyed-alike.

**To Order, Specify:**

- 1) Product number.
- 2) Wood finish color.

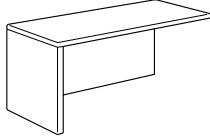

# PLACES

	Height	Depth	Width	Return	Number	Wood Finish Group	
						I	II
<b>Desk-Height Return Case — Full-Height Modesty Panel</b>    WRE2 (Left-hand shown)	29" (737mm)	24" (610mm)	36" (914mm)	Right	WRE2-2436-R	\$1059	\$1156
			36" (914mm)	Left	WRE2-2436	1059	1156
			42" (1067mm)	Right	WRE2-2442-R	1110	1211
			42" (1067mm)	Left	WRE2-2442	1110	1211
			48" (1219mm)	Right	WRE2-2448-R	1147	1250
			48" (1219mm)	Left	WRE2-2448	1147	1250
			60" (1524mm)	Right	WRE2-2460-R	1241	1353
			60" (1524mm)	Left	WRE2-2460	1241	1353

- Wood veneer top with solid wood edge trim.
- SPECIAL NOTE: Return cases can only attach to a 66"(1676mm)- or 72"(1829mm)-wide single pedestal desk. A left-hand return case is specified for a right-hand single pedestal desk, and a right-hand return case is specified for a left-hand single pedestal desk.
- Accepts optional pedestals, see pages 99-101.

**To Order, Specify:**

- 1) Product number.
- 2) Wood finish color.

# PLACES

	Height	Depth	Width	Return	Number	Wood Finish Group	
						I	II
<b>Desk-Height Return — Full-Height Modesty Panel</b>	29" (737mm)	24" (610mm)	36" (914mm)	Right with 6"/6"/12"	WRE2-2436-HR	\$2025	\$2211
				Right with 12"/12"	WRE2-2436-JR	2025	2211
				Left with 6"/6"/12"	WRE2-2436-H	2025	2211
				Left with 12"/12"	WRE2-2436-J	2025	2211
				Right with 6"/6"/12"	WRE2-2442-HR	\$2076	\$2266
				Right with 12"/12"	WRE2-2442-JR	2076	2266
	42" (1067mm)			Left with 6"/6"/12"	WRE2-2442-H	2076	2266
				Left with 12"/12"	WRE2-2442-J	2076	2266
				Right with 6"/6"/12"	WRE2-2448-HR	\$2113	\$2305
				Right with 12"/12"	WRE2-2448-JR	2113	2305
				Left with 6"/6"/12"	WRE2-2448-H	2113	2305
				Left with 12"/12"	WRE2-2448-J	2113	2305
60" (1524mm)			Right with 6"/6"/12"	WRE2-2460-HR	\$2207	\$2408	
			Right with 12"/12"	WRE2-2460-JR	2207	2408	
			Left with 6"/6"/12"	WRE2-2460-H	2207	2408	
			Left with 12"/12"	WRE2-2460-J	2207	2408	

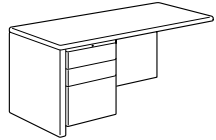

WRE2-H  
(Left-hand shown)

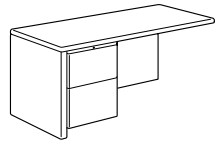

WRE2-J  
(Left-hand shown)

- Wood veneer top with solid wood edge trim.
- Available with a 6"/12"(152mm/305mm), 6"/6"/12"(152mm/152mm/305mm), or 12"/12"(305mm/305mm) pedestal.
- SPECIAL NOTE: Returns can only attach to a 66"(1676mm)- or 72"(1829mm) -wide single pedestal desk. A left-hand return is specified for a right-hand single pedestal desk, and a right-hand return is specified for a left-hand single pedestal desk.
- All pedestals are shipped with lock shells; lock plugs are field installed. Multiple locking units have random key numbers unless specified keyed-alike.

**To Order, Specify:**

- 1) Product number.
- 2) Wood finish color.

# PLACES

	Height	Depth	Width	Number	Wood Finish Group	
					I	II
<b>Desk-Height Bridge — Full-Height Modesty Panel</b>	29"(737mm)	24"(610mm)	36"(914mm)	WBE2-2436	\$664	\$725
			42"(1067mm)	WBE2-2442	706	770
			48"(1219mm)	WBE2-2448	753	821
			60"(1524mm)	WBE2-2460	843	918

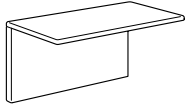

WBE2

- Wood veneer top with solid wood edge trim.
- Must be supported by a freestanding component on both ends.

**To Order, Specify:**

- 1) Product number.
- 2) Wood finish.

# PLACES

	Height	Depth	Width	Number	Wood Finish Group	
					I	II
<b>Credenza Case — Full-Height Back Panel</b>	29"(737mm)	24"(610mm)	60"(1524mm)	WCF2-2460	\$1304	\$1420
			66"(1676mm)	WCF2-2466	1428	1558
			72"(1829mm)	WCF2-2472	1595	1739

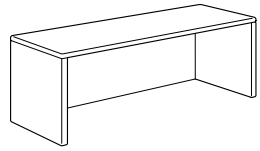

WCF2

- Wood veneer top with solid wood edge trim.
- Outside and inside back of credenza case are completely finished.
- Accepts optional pedestals, see pages 99-101.

**To Order, Specify:**

- 1) Product number.
- 2) Wood finish color.

	Height	Depth	Width	Access	Number	Wood Finish Group	
						I	II
<b>Credenza Case — Full-Height Back Panel — Right- or Left-Hand Access</b>	29" (737mm)	24" (610mm)	60" (1524mm)	Right-hand	WCF2-2460-R	\$1266	\$1379
				Left-hand	WCF2-2460-L	1266	1379
			72" (1829mm)	Right-hand	WCF2-2472-R	\$1549	\$1689
				Left-hand	WCF2-2472-L	1549	1689

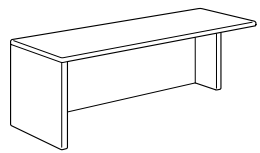

WCF2-L  
WCF2-R  
(Right-hand access shown)

- Wood veneer top with solid wood edge trim.
- Recessed end panel for free leg access to 90° corner to which unit must be attached, see page 95.
- Accepts optional pedestals, see pages 99-101.

**To Order, Specify:**

- 1) Product number.
- 2) Wood finish color.

# PLACES

	Height	Depth	Width	Drawer/Door Configuration	Number	Wood Group I	Finish II
<b>Credenza — Full-Height Back Panel — Standard Pedestals</b>	29" (737mm)	24" (610mm)	60" (1524mm)	6"/6"/12" l & r, doors	WCF2-2460-HTH	\$3831	\$4175
				12"/12" l & r, open	WCF2-2460-JJ	3217	3505
			66" (1676mm)	6"/6"/12" l & r, doors	WCF2-2466-HTH	\$3955	\$4313
				12"/12" l & r, open	WCF2-2466-JJ	3341	3643
			72" (1829mm)	6"/6"/12" l & r, doors	WCF2-2472-HTH	\$4122	\$4494
				12"/12" l & r, open	WCF2-2472-JJ	3508	3824

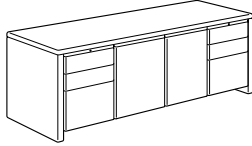

WCF2-HTH

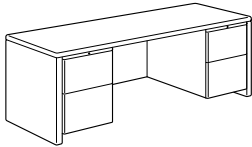

WCF2-JJ

- Wood veneer top with solid wood edge trim.
- Outside and inside back of credenza are completely finished.
- Available with 6"/6"/12" (152mm/152mm/305mm) and 12"/12" (305mm/305mm) pedestals.
- Available with a two-door center storage unit that includes one adjustable shelf or with kneespace opening.
- All credenzas are shipped with lock shells installed; lock plugs are field installed. Multiple locking units have random key numbers unless specified keyed-alike.

**To Order, Specify:**

- 1) Product number.
- 2) Wood finish color.

# PLACES

	Height	Depth	Width	Drawer/ Door Configuration	Number	Wood Finish Group I	Wood Finish Group II
<b>Credenza — Full-Height Back Panel — Standard Pedestals — Lateral Files</b>			72" (1829mm)	12"/12" l & r, files	WCF2-2472-JFJ	\$4214	\$4594

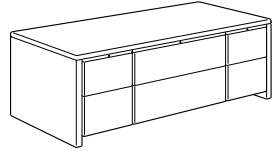

WCF2-JFJ

- Wood veneer top with solid wood edge trim.
- Outside and inside back of credenza are completely finished.
- Available with 6"/6"/12" (152mm/152mm/305mm) and 12"/12" (305mm/305mm) pedestals.
- Two-drawer lateral files accommodate letter, legal, EDP, A4, and foolscap paper sizes.
- Specify an FTB-15 for front-to-back filing (page 108).
- Lateral file drawer widths:
  - 72" (1829mm) -wide case=36" (914mm)
- All credenzas are shipped with lock shells installed; lock plugs are field installed. Multiple locking units have random key numbers unless specified keyed-alike.

**To Order, Specify:**

- 1) Product number.
- 2) Wood finish color.

# PLACES

	Height	Depth	Width	Number	Wood Finish Group	
					I	II
<b>90° Corners — Full-Height Modesty Panels</b>	29"(737mm)	24"(610mm)	36"(914mm)	WCC2-2436	\$1249	\$1361
			48"(1219mm)	WCC2-2448	1362	1485

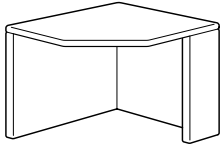

WCC2

- Wood veneer top with solid wood edge trim.
- Attaches to credenza case — right- or left-access on one side (page 92) and 24"(610mm) -deep bridge (page 91) on the other side.
- Prepared to accept separately-specified adjustable keyboard pad, see page 103.
- End support panel is field installed left or right.

**To Order, Specify:**

- 1) Product number.
- 2) Wood finish color.

<b>Convergents — Fixed Height</b>	29"(737mm)	60"(1524mm)	30"(762mm)	HWD2-6030-WW	\$1034	\$1116
		72"(1829mm)	30"(762mm)	HWD2-7230-WW	1181	1275
			36"(914mm)	HWD2-7236-WW	1352	1458

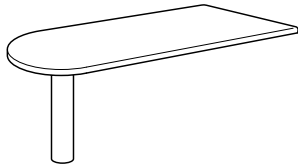

HWD2-WW

- Wood veneer top with solid wood edge trim.
- Wood support column with adjustable leveling glide.
- Attach to credenza case.

**To Order, Specify:**

- 1) Product number.
- 2) Wood finish color.

<b>Convergents — D-Shaped — with Modesty Panel</b>	29"(737mm)	60"(1524mm)	30"(762mm)	WDD2-3060-W	\$1559	\$1700
		72"(1829mm)	30"(762mm)	WDD2-3072-W	1751	1909
			36"(914mm)	WDD2-3672-W	1954	2130

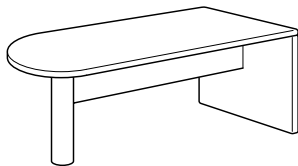

WDD2-W

- Wood veneer top with solid wood edge trim.
- Wood support column with adjustable leveling glide.
- Center modesty is 10"(254mm) -high.
- Must attach to bridge, or credenza case — left- or right-access; cannot stand alone.

**To Order, Specify:**

- 1) Product number.
- 2) Wood finish color.

# PLACES

## Vertical Storage Unit — Hinged Door Unit with Tackboards

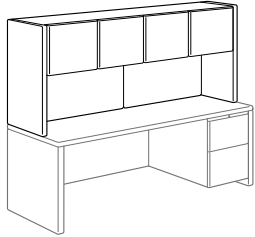

WVHT

Height	Depth	Width	Description	Number	Fabric Grade		
					A	B	C
<b>Wood Price Group I</b>							
38"(965mm)	14 1/2"(368mm)	60"(1524mm)	Non-Locking	WVHT-3860	\$2618	\$2627	\$2645
		66"(1676mm)		WVHT-3866	2785	2797	2826
		72"(1829mm)		WVHT-3872	2859	2871	2900
38"(965mm)	14 1/2"(368mm)	60"(1524mm)	Locking	WVHT-3860-L	\$2735	\$2744	\$2762
		66"(1676mm)		WVHT-3866-L	2902	2914	2943
		72"(1829mm)		WVHT-3872-L	2976	2988	3017
<b>Wood Price Group II</b>							
38"(965mm)	14 1/2"(368mm)	60"(1524mm)	Non-Locking	WVHT-3860	\$2811	\$2820	\$2838
		66"(1676mm)		WVHT-3866	2983	2995	3024
		72"(1829mm)		WVHT-3872	3063	3075	3104
38"(965mm)	14 1/2"(368mm)	60"(1524mm)	Locking	WVHT-3860-L	\$2928	\$2937	\$2955
		66"(1676mm)		WVHT-3866-L	3100	3112	3141
		72"(1829mm)		WVHT-3872-L	3180	3192	3221

- Four hinged doors concealing two interior compartments.
- Fabric covered tackboards.
- Available with or without locks.
- For additional features, see below.

### To Order, Specify:

- 1) Product number.
- 2) Wood finish color.
- 3) Fabric surface and color.

### Features

- Finished wood outside back for freestanding applications.
- Interior clearance height is 12 5/8"(320mm).
- Total height when mounted on a desk or credenza is 68"(1727mm).
- Vertical storage units attach to the top of desk and credenza units of equal width; they may not span over two base units.
- Attachment hardware is included in price.
- Specify mounting template separately, see page 98.
- When unit is attached to a single desk or credenza shell, the base unit must have one suspended pedestal or under surface lateral file attached to it for stability.
- When units are attached to base unit shells that themselves are attached to adjacent bridges, returns, or corner units, pedestals are not required.
- Accepts only under counter task lights with mounting bars (see page 98).
- Task lights must be the next size increment smaller than storage unit width.
  - 60"(1524mm) -wide unit accepts task lights up to 54"(1372mm) -wide.
  - 66"(1676mm) - and 72"(1829mm) -wide units accept task lights up to 60"(1524mm) -wide.
- Units come standard with pass-through cut-outs to route task light cords.
- Locking units feature two locks and may be specified keyed-alike or master keyed.
- Tackboards not interchangeable with PLACES system tackboards.



# PLACES

**Vertical Storage Unit —  
Flipper Door Unit with  
Tackboards**

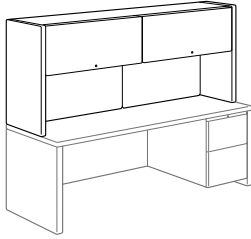

WVFT

Height	Depth	Width	Number	Fabric Grade		
				A	B	C
<b>Wood Price Group I</b>						
38"(965mm)	14 1/2"(368mm)	60"(1524mm)	WVFT-3860	\$2618	\$2627	\$2645
		66"(1676mm)	WVFT-3866	2785	2797	2826
		72"(1829mm)	WVFT-3872	2859	2871	2900
<b>Wood Price Group II</b>						
38"(965mm)	14 1/2"(368mm)	60"(1524mm)	WVFT-3860	\$2811	\$2820	\$2838
		66"(1676mm)	WVFT-3866	2983	2995	3024
		72"(1829mm)	WVFT-3872	3063	3075	3104

- 60"(1524mm) -wide model features one flipper door; 66"(1676mm) - and 72"(1829mm) -wide models feature two flipper doors and two interior compartments.
- Fabric covered tackboards.
- Locks standard.
- For additional features, see below.

**To Order, Specify:**

- 1) Product number.
- 2) Wood finish color.
- 3) Fabric surface and color.

**Features**

- Finished wood outside back for freestanding applications.
- Interior clearance height is 12 5/8"(320mm).
- Total height when mounted on a desk or credenza is 68"(1727mm).
- Vertical storage units attach to the top of desk and credenza units of equal width; they may not span over two base units.
- Attachment hardware is included in price.
- Specify mounting template separately, see page 98.
- When unit is attached to a single desk or credenza shell, the base unit must have one suspended pedestal or under surface lateral file attached to it for stability.
- When units are attached to base unit shells that themselves are attached to adjacent bridges, returns, or corner units, pedestals are not required.
- Accepts only under counter task lights with mounting bars (see page 98).
- Task lights must be the next size increment smaller than storage unit width.
  - 60"(1524mm) -wide unit accepts task lights up to 54"(1372mm) -wide.
  - 66"(1676mm) - and 72"(1829mm) -wide units accept task lights up to 60"(1524mm) -wide.
- Units come standard with pass-through cut-outs to route task light cords.
- Locking units feature two locks and may be specified keyed-alike or master keyed.
- Tackboards not interchangeable with PLACES system tackboards.

# PLACES

	Height	Depth	Width	Number	Price
<b>Fixed-Intensity Task Lighting</b>	1 3/4"(44mm)	5 1/4"(133mm)	24"(610mm)	HTLU-0024	\$172
			30"(762mm)	HTLU-0030-T	179
			36"(914mm)	HTLU-0036-T	192
			42"(1067mm)	HTLU-0042-T	195
			48"(1219mm)	HTLU-0048-T	199
			54"(1372mm)	HTLU-0054-T	210
			60"(1524mm)	HTLU-0060-T	216

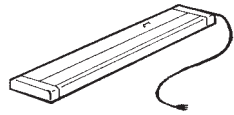

HTLU  
HTLU-T



Class BA

- Provides task lighting beneath counter tops.
- Six-foot cord installed on right side; may be field installed on left side. The Chicago cord includes 2.5 amp resettable circuit breaker in the plug.
- Units shipped with T-8 **low mercury content** octic fluorescent lamp with a 3500K color temperature, except for 24" lights, which are shipped with a T-8 cool white lamp.
- Includes mounting screws.
- **For use with 120 volt 60 hertz electrical systems only.**
- Price includes lens, cord and T-8 fluorescent lamp.

**To Order, Specify:**

- 1) Product number.
- 2) Trim color.

**Chicago Specification:**

To specify add **C** in the product number and **\$65** list.

**Example:** HTLU-0024-C

HTLU-0030-CT

## Task Light Mounting Bracket

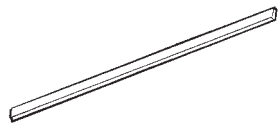

5330-2901  
Class AA

- For installing task lights under vertical storage units.
- Specify two (2) brackets for each fixture.

5330-2901

N/C

**To Order, Specify:**

- 1) Product number.  
(No finish specification required.)

## Vertical Storage Unit Template — Wood Units

Class OA

- Steel template for locating holes for connection hardware in top of supporting casegoods for vertical storage unit.
- May be reused for all wood vertical storage unit installations.

WVT-1

\$11

**To Order, Specify:**

- 1) Product number.  
(No finish specification required.)

# PLACES

	Height	Depth	Width	Drawer Stack	Number	Wood Finish Group	
						I	II
<b>Suspended Pedestal — Standard-Width</b>	19" (483mm)	24" (610mm)	15 3/4" (400mm)	6"/12" (152mm/305mm)	DS-24-AWL	\$862	\$ 931
	22" (559mm)			3"/6"/12" (76mm/152mm/305mm)	DS-24-DWL	946	1023
	25" (635mm)			6"/6"/12" (152mm/152mm/305mm)	DS-24-HWL	976	1056
	25" (635mm)			12"/12" (305mm/305mm)	DS-24-JWL	976	1056

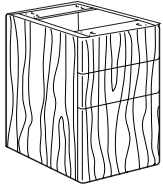

DS

- Solid wood edge banding matches finish of wood veneer surfaces.
- Recessed pulls in sides of drawers.
- Locks standard on all units.
- Note: Drawer sizes/positions are preset as specified and are not interchangeable.
- Specify lateral file conversion kit bars (page 108) for side-to-side filing in 12"(305mm) -deep drawers.
- Only one pedestal can be suspended from each systems worksurface; two may be installed (one left, one right) on credenza case or desk shell.

**To Order, Specify:**

- 1) Product number.
- 2) Wood finish color.

<b>Suspended Pedestal with Base — Standard-Width</b>	27 1/2" (699mm)	24" (610mm)	15 3/4" (400mm)	6"/6"/12" (152mm/152mm/305mm)	PDS-24-HWBL	\$986	\$1064
				12"/12" (305mm/305mm)	PDS-24-JWBL	986	1064

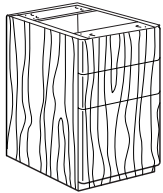

PDS

- Solid wood edge banding matches finish of wood veneer surfaces.
- Recessed pulls in sides of drawers.
- Locks standard on all units.
- Note: Drawer sizes/positions are preset as specified and are not interchangeable.
- Specify lateral file conversion kit bars (page 108) for side-to-side filing in 12"(305mm) -deep drawers.
- **Non-structural base is left- or right-handed.**
- Only one pedestal can be suspended from each systems worksurface; two may be installed (one left, one right) on credenza case or desk shell.

**To Order, Specify:**

- 1) Product number.
- 2) Wood finish color.

<b>Fixed Pedestal — Standard-Width</b>	27 1/2" (699mm)	24" (610mm)	15 3/4" (400mm)	6"/6"/12" (152mm/152mm/305mm)	DX-24-HWL	\$1196	\$1292
				12"/12" (305mm/305mm)	DX-24-JWL	1196	1292

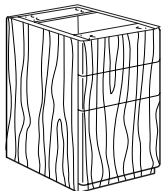

DX

- Solid wood edge banding matches finish of wood veneer surfaces.
- Recessed pulls in sides of drawers.
- Locks standard on all units.
- Note: Drawer sizes/positions are preset as specified and are not interchangeable.
- Specify lateral file conversion kit bars (page 108) for side-to-side filing in 12"(305mm) -deep drawers.

**To Order, Specify:**

- 1) Product number.
- 2) Wood finish color.

# PLACES

	Height	Depth	Width	Drawer Stack	Number	Wood Finish Group	
						I	II
<b>Mobile Pedestal — Standard-Width</b>	27 5/8" (702mm)	24" (610mm)	15 3/4" (400mm)	6"/6"/12" (152mm/152mm/305mm)	DM-24-HWL	\$1253	\$1353
	27 5/8" (702mm)			12"/12" (305mm/305mm)	DM-24-JWL	1253	1353

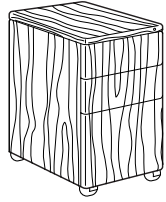

DM

- Solid wood edge banding matches finish of wood veneer surfaces.
- Recessed pulls in sides of drawers.
- Counterbalance weight standard on mobile pedestals.
- Locks standard on all units.
- Mobile unit casters are charcoal finish color.
- Note: Drawer sizes/positions are preset as specified and are not interchangeable.
- Specify lateral file conversion kit bars (page 108) for side-to-side filing in 12" (305mm) -deep drawers.

**To Order, Specify:**

- 1) Product number.
- 2) Wood finish color.

<b>Stationary Pedestal — Standard-Width</b>	27 5/8" (702mm)	24" (610mm)	15 3/4" (400mm)	6"/6"/12" (152mm/152mm/305mm)	DF-24-HWL	\$1142	\$1234
	27 5/8" (702mm)			12"/12" (305mm/305mm)	DF-24-JWL	1142	1234

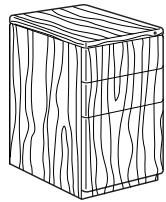

DF

- Solid wood edge banding matches finish of wood veneer surfaces.
- Recessed pulls in sides of drawers.
- Locks standard on all units.
- Note: Drawer sizes/positions are preset as specified and are not interchangeable.
- Specify lateral file conversion kit bars (page 108) for side-to-side filing in 12" (305mm) -deep drawers.

**To Order, Specify:**

- 1) Product number.
- 2) Wood finish color.

# PLACES

	Height	Depth	Width	Drawer Stack	Number	Wood Finish Group	
						I	II
<b>Fixed Pedestal — Legal-Width</b>	27 1/2"	24"	18 3/4"	6"/6"/12"	DXL-24-CWL	\$1404	\$1539
	(699mm)	(610mm)	(476mm)	(152mm/152mm/305mm)			
				12"/12"	DXL-24-QWL	1404	1539
				(305mm/305mm)			

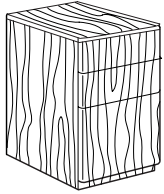

DXL

- Solid wood edge banding matches finish of wood veneer surfaces.
- Recessed pulls in sides of drawers.
- Locks standard on all units.
- Note: Drawer sizes/positions are preset as specified and are not interchangeable.
- File drawers accommodate suspended legal file folders, front-to-back.

**To Order, Specify:**

- 1) Product number.
- 2) Wood finish color.

# PLACES

	Height	Depth	Width	Number	Wood Finish Group	
					I	II
<b>Two-High Undersurface Lateral File</b>	27 1/2"(699mm)	24"(610mm)	30"(762mm)	DSLFL-3024-JWBL	\$1314	\$1447
			36"(914mm)	DSLFL-3624-JWBL	1395	1535

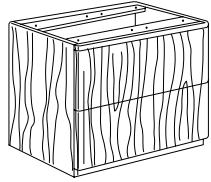

DSLFL

- Unfinished top designed to be attached to underside of PLACES system worksurface on wood caseloads 24"(610mm) or deeper.
- Radiused corner will match corner radius of PLACES wood worksurfaces and laminate worksurfaces with wood trim only.
- Finished wood back.
- May replace worksurface support brackets when used with worksurfaces of equal width or single bracket at either end when flush with end of longer worksurfaces.
- 12"(305mm) -high, wood-construction file drawers feature side-to-side hanging bars for suspended file folders.
- Back hanging bar is adjustable for letter, legal, A4, foolscap, and EDP paper sizes.
- Front-to-back filing for all paper stock sizes may be accomplished by separate specification of front-to-back hanging bars (page 108).
- Units are lockable and have random key numbers unless specified keyed alike.
- Includes four, one-inch adjustable leveling glides.

**To Order, Specify:**

- 1) Product number.
- 2) Wood finish color.

# PLACES

	Height	Keyboard Depth	Pad Width	Description	Number	Price
<b>Adjustable Keyboard Pads</b>	6"(152mm)	11.4"(290mm)	19.5"-27.8" (495-706mm)	17"(432mm) track Comfort Palm Rest	AKPM-17-SL	<b>\$242</b>
				21"(533mm) track Comfort Palm Rest	AKPM-21-SL	<b>242</b>

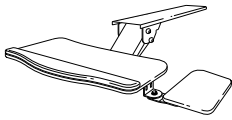

AKPM-17-SL

- Vertical adjustment range of 6"(152mm) below worksurface.
- Keyboard tray and mouse pad tilt +/-15°.
- Palm Rest is soft comfort version and standard in graphite color only.
- Base, mouse pad and optional mouse pad cover insert standard in charcoal only.
- Mouse pad is interchangeable and has dual swivel and independent tilt.
- 360° rotation.
- 17"(432mm) track fits under worksurfaces 18"(457mm) or deeper.
- 21"(533mm) track fits under worksurfaces 22"(559mm) or deeper.
- Recommended for most corner applications.

**To Order, Specify:**

- 1) Product number.  
(No finish specification required.)

**Mouse Pad Cover Option:**

To order with mouse pad cover (not shown); add **M** to product number and add **\$10**.

*Example:* AKPM-17-SLM

<b>Adjustable Keyboard Pad</b>	6"(152mm)	5.25"(133mm)	19.5"-27.8" (495-706mm)	23"(584mm) track Comfort Palm Rest	AKPM-23-SF	<b>\$336</b>
--------------------------------	-----------	--------------	----------------------------	---------------------------------------	------------	--------------

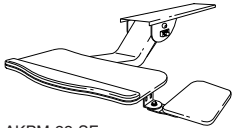

AKPM-23-SF

- Vertical adjustment range of 12"(305mm); 6"(152mm) below worksurface and 6.75"(171mm) above.
- Keyboard tray and mouse pad tilt +/-15° using soft touch knob.
- Palm Rest is soft comfort version and standard in graphite color only.
- Base, mouse pad and optional mouse pad cover insert standard in charcoal only.
- Mouse pad is interchangeable and has dual swivel and independent tilt.
- 360° rotation.
- 23"(584mm) track fits under worksurfaces 24"(610mm) or deeper.
- Recommended for most corner applications.

**To Order, Specify:**

- 1) Product number.  
(No finish specification required.)

**Mouse Pad Cover Option:**

To order with mouse pad cover (not shown); add **M** to product number and add **\$10**.

*Example:* AKPM-23-SFM

**Positive Tilt Lock-Out Option:**

For positive tilt lock-out option (0 to -15° tilt only), add suffix **P** to the product number.

*Example:* AKPM-23-SFP

**Both Options:** AKPM-23-SFPM

## PLACES

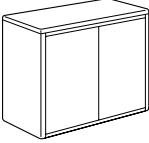
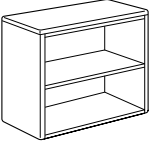
	Height	Depth	Width	Shelf Openings	Number	Wood Finish Group	
						I	II
<b>Two-High Bookcase with Doors</b>	29" (737mm)	13 1/2" (343mm)	30" (762mm)	2	WBF2-3029-D	\$1265	\$1378
			36" (914mm)		WBF2-3629-D	\$1332	\$1454
							
WBF2-D							
						<b>To Order, Specify:</b>	
						1) Product number.	
						2) Wood finish color.	
<b>Two-High Bookcase</b>	29" (737mm)	13 1/2" (343mm)	30" (762mm)	2	WBF2-3029	\$948	\$1037
			36" (914mm)		WBF2-3629	999	1095
							
WBF2							
						<b>To Order, Specify:</b>	
						1) Product number.	
						2) Wood finish color.	



# PLACES

	Height	Depth	Width	Shelf Openings	Number	Wood Finish Group	
						I	II

**Three-High Bookcase**

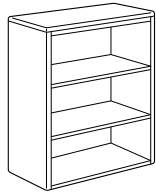

42"(1067mm)      13 1/2"(343mm)      36"(914mm)

3      WBF1-3642      \$1211      \$1325

- Standard 12 5/8"(321mm) opening between shelves.
- Shelves are adjustable in 1 1/4"(31mm) increments.
- Equipped with adjustable glides.
- Back is finished.
- Two adjustable shelves.

**To Order, Specify:**

- 1) Product number.
- 2) Wood finish color.

WBF1

**Four-High Bookcase**

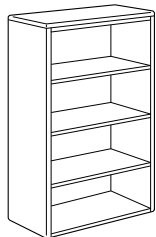

54"(1372mm)      36"(914mm)

4      WBF1-3654      \$1448      \$1586

- Standard 12 5/8"(321mm) opening between shelves.
- Shelves are adjustable in 1 1/4"(31mm) increments.
- Equipped with adjustable glides.
- Back is finished.
- Second shelf from the bottom on four-high unit is semi-fixed.
- Two adjustable shelves; one semi-fixed shelf.

**To Order, Specify:**

- 1) Product number.
- 2) Wood finish color.

WBF1

**Five-High Bookcase**

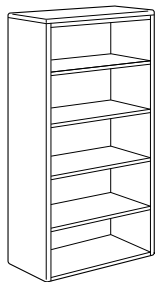

68"(1727mm)      36"(914mm)

5      WBF1-3668      \$1659      \$1817

- Standard 12 5/8"(321mm) opening between shelves.
- Shelves are adjustable in 1 1/4"(31mm) increments.
- Equipped with adjustable glides.
- Back is finished.
- Second shelf from the bottom on five-high unit is semi-fixed.
- Three adjustable shelves; one semi-fixed shelf.

**To Order, Specify:**

- 1) Product number.
- 2) Wood finish color.

WBF1

**Bookcase Shelf**

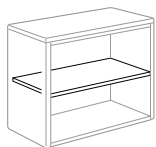

Height	Depth	Case Width
13 1/16"(21mm)	11 7/8"(302mm)	36"(914mm)

Number	Wood Finish Group	
	I	II
WBFS-0036	\$141	\$155

- Replacement shelf for bookcases.

**To Order, Specify:**

- 1) Product number.
- 2) Wood finish color.

WBFS

## PLACES

	Height	Depth	Width	Number	Wood Finish Group	
					I	II
<b>Wardrobe Unit</b>	68"(1727mm)	20"(508mm)	30"(762mm)	WWC-3068	<b>\$1978</b>	<b>\$2176</b>
			36"(914mm)	WWC-3668	<b>2074</b>	<b>2282</b>

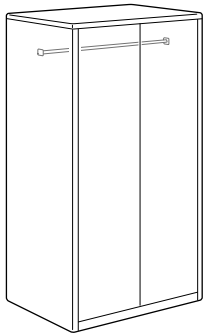

WWC

- Veneered and finished on all exposed sides including backs.
- Doors feature touch latch opening.
- Full-width, chrome-plated garment rod.
- Standard with lock. Lock numbers will be random unless specified keyed alike.

**To Order, Specify:**

- 1) Product number.
- 2) Wood finish color.

	Height	Depth	Width	Number	Wood Finish Group	
					I	II
<b>Wardrobe/Storage Unit</b>	68"(1727mm)	20"(508mm)	30"(762mm)	WWP-3068	<b>\$2376</b>	<b>\$2613</b>
			36"(914mm)	WWP-3668	<b>2494</b>	<b>2743</b>

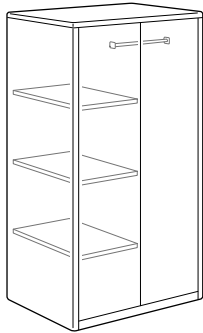

WWP

- Veneered and finished on all exposed sides including backs.
- Doors feature touch latch opening.
- One-half width garment area with chrome-plated garment rod.
- Full-depth, full-height divider between garment area and shelves.
- Three, fully-adjustable shelves in 1 1/4"(31mm) increments and one fixed shelf.
- Standard with lock. Lock numbers will be random unless specified keyed alike.

**To Order, Specify:**

- 1) Product number.
- 2) Wood finish color.

# PLACES

	Height	Depth	Width	Number	Wood Finish Group	
					I	II
<b>Storage Unit</b>	68"(1727mm)	20"(508mm)	30"(762mm)	WWS-3068	\$2308	\$2539
			36"(914mm)	WWS-3668	2423	2665

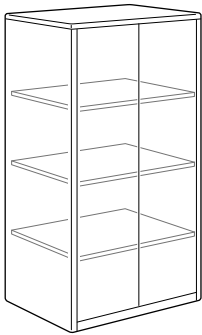

WWS

- Veneered and finished on all exposed sides including backs.
- Doors feature touch latch opening.
- Three, fully-adjustable shelves in 1 1/4"(31mm) increments and one fixed shelf.
- Standard with lock. Lock numbers will be random unless specified keyed alike.

**To Order, Specify:**

- 1) Product number.
- 2) Wood finish color.

	Height	Depth	Width	Number	Wood Finish Group	
					I	II
<b>Storage/File Unit</b>	68"(1727mm)	20"(508mm)	30"(762mm)	WWD-3068	\$2564	\$2820
			36"(914mm)	WWD-3668	2690	2959

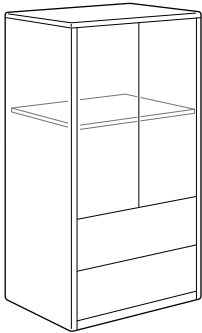

WWD

- Veneered and finished on all exposed sides including backs.
- Two-door upper storage compartment with two, lateral file drawers in base.
- Doors feature touch latch opening.
- Wood construction lateral file drawers feature side-to-side hanging bars for suspended file folders.
- Back hanging bar is adjustable for letter, legal, A4, foolscap, and EDP paper sizes.
- See page 108 for front-to-back hanging bars (EDP-depth only).
- One fully-adjustable shelf in 1 1/4"(31mm) increments.
- Standard with two (2) locks: storage door and file unit. Lock numbers will be random unless specified keyed alike.

**To Order, Specify:**

- 1) Product number.
- 2) Wood finish color.

	Height	Depth	Case Width	Description	Number	Wood Finish Group	
						I	II
<b>Wardrobe/Storage Unit Shelf</b>	13/16"(21mm)	18 1/4"(464mm)	30"(762mm)	For wardrobe/ storage unit	WWPS-0030	\$110	\$121
			36"(914mm)	For wardrobe/ storage unit	WWPS-0036	117	129
		18 3/4"(476mm)	30"(762mm)	For storage or storage/file unit	WWSS-0030	\$137	\$150
			36"(914mm)	For storage or storage/file unit	WWSS-0036	149	162

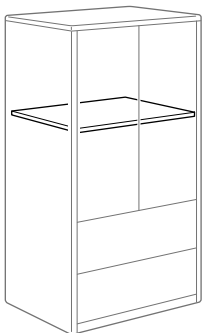

WWPS  
WWSS

- Shelves are sized to fit full widths of 30"(763mm) - and 36"(914mm) -wide storage, and storage/file units, and half widths of wardrobe/storage units.
- Specify as additional shelves when required.

**To Order, Specify:**

- 1) Product number.
- 2) Wood finish color.

# PLACES

	Height	Depth	Width	Systems Top Number	Standard Top Number	Wood Finish Group	
						I	II
<b>Two-High Lateral File</b>	29"(737mm)	20"(508mm)	30"(762mm)	WLF1-3029	WLF2-3029	\$1487	\$1653
			36"(914mm)	WLF1-3629	WLF2-3629	1594	1772

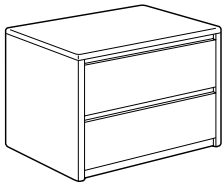

WLF1  
WLF2

- Wood lateral files are veneered and finished on all exposed surfaces including the back.
- Wood construction file drawers feature hanging bars for suspended file folders.
- Back hanging bar is adjustable for letter, legal, A4, foolscap, and EDP paper sizes (side-to-side storage).
- Front-to-back filing for all paper stock widths may be accomplished by separate specification of front-to-back hanging bars (see below).
- Standard with lock. Lock numbers will be random unless specified keyed alike.
- Safety interlock prevents more than one drawer from being opened at one time.
- Equipped with four leveling glides for 1"(25mm) vertical adjustment.
- Available with a 1 9/16"(39mm) standard top thickness or a 1 3/16"(30mm) systems top thickness.

**To Order, Specify:**

- 1) Product number.
- 2) Wood finish color.

	Height	Depth	Width	Number	Wood Finish Group	
					I	II
<b>Four-High Lateral File</b>	54"(1372mm)	20"(508mm)	30"(762mm)	WLF1-3054	\$2065	\$2295
			36"(914mm)	WLF1-3654	2169	2410

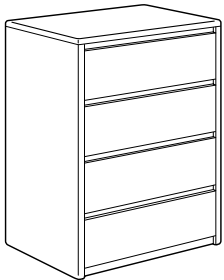

WLF1

- Wood lateral files are veneered and finished on all exposed surfaces including the back.
- Wood construction file drawers feature hanging bars for suspended file folders.
- Back hanging bar is adjustable for letter, legal, A4, foolscap, and EDP paper sizes (side-to-side storage).
- Front-to-back filing for all paper stock widths may be accomplished by separate specification of front-to-back hanging bars (see below).
- Standard with lock. Lock numbers will be random unless specified keyed alike.
- Safety interlock prevents more than one drawer from being opened at one time.
- Equipped with four leveling glides for 1"(25mm) vertical adjustment.

**To Order, Specify:**

- 1) Product number.
- 2) Wood finish color.

<b>Front-to-Back Hanging Bars</b>	Length	Number	Price
	15 3/4"(400mm)	FTB-15	\$20

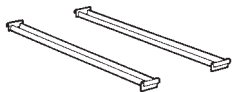

FTB-15

- Front-to-back hanging bars may be used with both file widths.
- Use in drawers set for EDP storage depth.
- Price includes two (2) bars.
- Standard in black finish color only.

**To Order, Specify:**

- 1) Product number.  
(No finish specification required.)

<b>File Conversion Kit</b>	Height	Depth	Width	Number	Price
	1/2"(13mm)	12 3/8"(314mm)	1"(25mm)	FCK-13	\$36



FCK-13

- For side-to-side, letter or legal filing in standard width, wood pedestal drawers.
- Price includes three (3) bars.

**To Order, Specify:**

- 1) Product number.
- 2) Finish color.  
TR-R Beige  
TR-K Charcoal  
TR-G Gray Tone

# PLACES

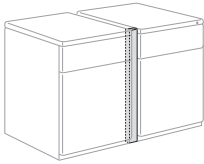
	Height	Depth	Width	Pedestal Application	Number	Wood Finish Group	
						I	II
 PS-F PS-C	25 1/8"(638mm)	3/4"(19mm)	1"(25mm)	25 1/8"(638mm) -high stationary	PS-25-F	\$38	\$45
	28 1/8"(714mm)			28 1/8"(714mm) -high stationary	PS-28-F	\$42	\$49
	28 1/8"(714mm)			28 1/8"(714mm) -high suspended with base, fixed pedestal, or undersurface lateral file	PS-28-C	\$42	\$49

- For use with stationary pedestals, fixed pedestals, suspended pedestals with base, or undersurface lateral files **only**.
- Pedestal spacers must be specified when placing a stationary pedestal next to another pedestal or when placing an undersurface lateral file next to a suspended pedestal with base.
- Product applies to letter- and legal-width wood pedestals.
- Solid wood spacers mount to sides of pedestals.
- Permits access to the drawer pull vertical reveals when pedestals are situated side-by-side.
- Mounting hardware will not damage the pedestal case and may be removed for pedestal reconfiguration as required.

**To Order, Specify:**

- 1) Product number.
- 2) Wood finish color.

	Height	Depth	Width	Desk Application	Number	Wood Finish Group	
						I	II
 CD-W	3"(76mm)	18 1/4"(464mm)	25"(635mm)	60"(1524mm)	CD-60-W	\$204	\$223

- Includes a built-in pencil tray.
- Features full-extension slides.
- Will not fit under convergent with modesty panel.

**To Order, Specify:**

- 1) Product number.
- 2) Wood finish color.

	Number	Price

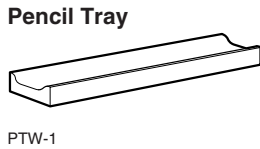

- Fits inside a 6"(152mm) -high drawer.
- Recommended if a center drawer is not specified.
- Wood finish matches drawer interior.

**To Order, Specify:**

- 1) Product number.  
(No finish specification required.)

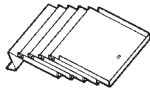
 MSD-6	MSD-6	\$66
--	-------	------

- Fits inside a 6"(152mm) -high drawer.
- Standard in black finish only.

**To Order, Specify:**

- 1) Product number.  
(No finish specification required.)

	Diameter	Number	Price



- For field installation only.
- Requires a 1 7/8"(48mm) diameter hole for installation.
- Standard in matte black finish only.

**To Order, Specify:**

- 1) Product number.  
(No finish specification required.)



**Varia by SMED****Product Offering**

The Varia casegoods product offering consists of the following:

Table Desks	Lateral Files
Double Pedestal Desks	Lateral File Combinations
Single Pedestal Desks	Wardrobe/Storage Units
Returns	Bookcases
Bridges	Vertical Storage Unit
D-Top Desks	Combination Vertical Storage Unit
P-Top Desks	Lectern
Credenzas	Serving Cart
Reception Stations	Telephone Stand
Credenza Tops	Video Cabinets
Credenza Storage	Presentation Boards
Corner Units	
VDT Tables	

**Construction Features****Top and Base Construction**

Varia casegoods tops and bases are constructed of a 2"(51mm)-thick particle board with 3/4"(19mm) x 2"(51mm) solid Agathis banding. Varia tops and bases are available with the following edge-detail options: Classic, Modern, and Traditional.

**Reveals**

Horizontal 7/16"(11mm) reveals separate the top from the pedestal or end-panel, and the plinth base from the pedestal. Reveals may be specified in black or brass.

**Pedestals**

All pedestal corners and edges are banded with solid Agathis.

Desk pedestals are 16 1/2"(415mm) wide and 30"(762mm) deep. Credenza and return pedestals are available in one width, 16 1/2"(415mm). Lateral files are available in two widths, 30"(762mm) and 36"(914mm), and two depths, 20"(508mm) and 24"(610mm).

A 20"(508mm)-deep mobile pedestal is available for use under 30 1/8"(765mm)-high worksurfaces.

Pedestal orientation determined at time of order.

**Drawers**

The front, back, and sides of the drawer boxes are constructed of red oak wood veneer. Drawer corners are dowelled and glued for superior strength.

One pencil tray constructed of solid oak is provided with pedestals containing box drawers (only one pencil tray is provided per pedestal).

**Lock Program**

Desks, returns and credenzas with pedestals, wardrobe/storage cabinets, and lateral files each feature one or more locks. Vertical storage units are available with or without locks.

Tagged offices will be keyed alike.

All locks will have a bright zinc finish regardless of veneer type or wood finish color.

Refer to the current Lock Programs Specification Guidelines Price List for master keying. Contact the Haworth Order Services Inquiry Center for more information.

**Wood/Finish Features**

All Varia casegoods are constructed using quarter-cut or pinched Anegre veneers and Agathis solids.

Because of the natural properties of wood, variations of grain pattern and finish color can be expected. Materials used in the manufacturing of products are carefully selected to promote consistent and acceptable color. Wood is susceptible to color change from long-term exposure to sunlight.

To keep your wood writing surfaces beautiful for the life of the product, it is highly recommended that a blotter pad, glass or plexiglass be used under writing instruments.

Varia casegoods feature 80% fill Anegre veneers. Finishes are sprayed with two layers of conversion varnish. Writing surfaces are finished with a high sheen for a rich, durable, high-gloss look.

# Filing Capacities for Wood Pedestal Files/Lateral Files; Drawer Dimensions

## Pedestal Files — 16½" (415mm) Width

- One horizontal adjustable bar is included to accommodate side-to-side filing.

### 20" DEEP PEDESTALS

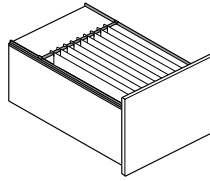

Legal/A4 Filing  
12¾" (324mm)

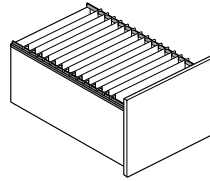

Letter/A4 Filing  
15½" (402mm)

### 24" DEEP PEDESTALS

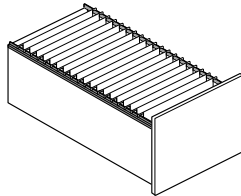

Letter/A4 Filing  
20¾" (529mm)

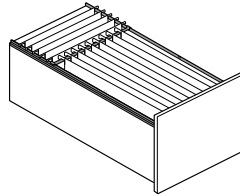

Legal/A4 and Letter Filing  
18¾" (468mm)

### 30" DEEP PEDESTALS

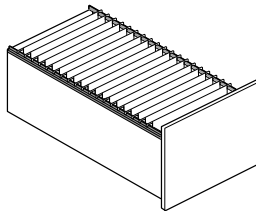

Letter/A4 Filing  
24¾" (631mm)

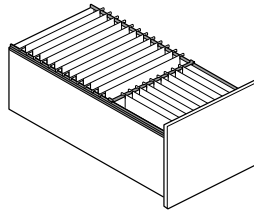

Legal/A4 and Letter Filing  
22½" (570mm)

## Lateral Files — 30" (762mm) Width

- Applies to separately-specified stationary lateral files, and lateral files on returns and credenzas.
- One adjustable bar is included to accommodate side-to-side filing.
- Two adjustable bars are included to accommodate dual front-to-back filing.

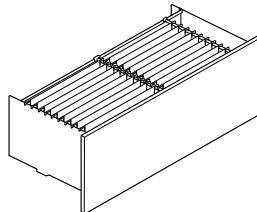

Letter/A4 Filing  
30¼" (770mm)

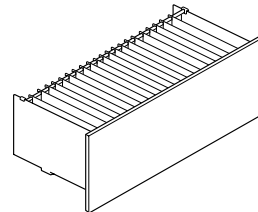

Letter, Legal, and A4 Filing  
26⅞" (682mm)

## Lateral Files — 36" (914mm) Width

- Applies to separately-specified stationary lateral files, and lateral files on returns and credenzas.
- One adjustable bar is included to accommodate side-to-side filing.
- Two adjustable bars are included to accommodate dual front-to-back filing.

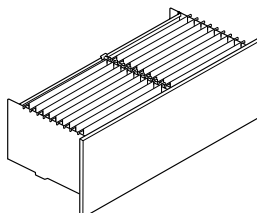

Legal Filing  
30¼" (770mm)

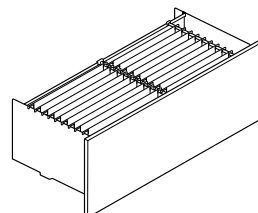

Letter/A4 Filing  
30¼" (770mm)

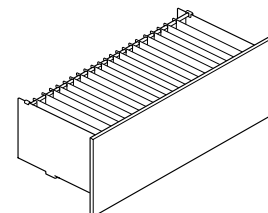

Letter, Legal, and A4 Filing  
32¼" (834mm)



# Varia by SMED

## Edge Details

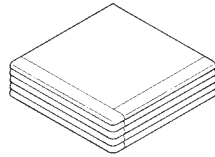

1 - Classic

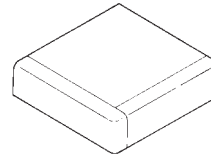

2 - Modern

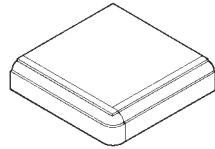

4 - Traditional

## General Guidelines for Product Specification

Varia product specification numbers are based on an alpha-numeric logic that identifies a product by product line, size, and certain characteristics.

For example, a product number that reads **ADRD-3060-1JHN** identifies the product as a double pedestal desk, 30" (762mm) deep and 60" (1524mm) wide with Classic edge-detail, a file/file left pedestal, a box/box/file right pedestal, and no grommet.

The alpha-numeric logic for a Varia double-pedestal desk with finish codes is shown below:

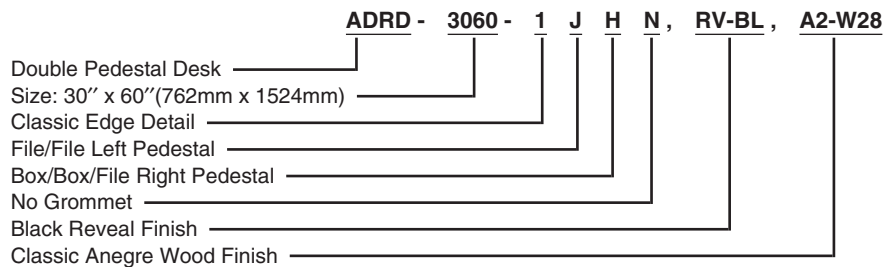

There are exceptions to this logic; therefore, always refer to the price charts for product numbers rather than attempting to construct them. Product number modification instructions for additional options appear in footnoted copy for each applicable product.

Beyond the printed product number, finish codes are required to complete an order specification. To communicate your order clearly, list the product number and finish codes in the sequence outlined on each page of the price list.

## Tag for Ordering

Varia is manufactured so that every piece in an office can be constructed from the same wood flitch. This provides superior color and grain matching. In order to meet these high standards, Haworth requires that all items in the order be tagged with an individual office location. Items will be manufactured, labeled, and shipped so that installers can easily identify items by office.

## Finishes and Fabrics

A complete listing of finishes and fabrics for Varia casegoods can be found on pages 207-211. Wood Group 3 is quarter-cut Anegre only and Wood Group 4 is Pinched Anegre. See pages 207-209 for finish colors.

# Varia by SMED

	Height	Depth	Width	Number	Wood Finish Group	
					3	4
<b>Table Desk</b>	30 1/8"(765mm)	36"(914mm)	72"(1829mm)	ADT-3672-■	\$3200	\$3360

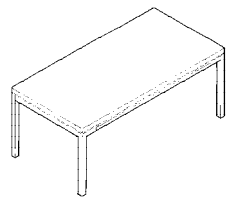

ADT-3672

- Four-leg construction.
- Rectangular top (2"(51mm) thick).
- Shipped unassembled.

### To Order, Specify:

- 1) Product number.  
–Specify edge detail as **8th digit** in product number.
  - 1** Classic
  - 2** Modern
  - 4** Traditional
- 2) Reveal finish color.
- 3) Wood finish color (Anegre).

# Varia by SMED

	Height	Depth	Width	Number	Wood Finish Group	
					3	4
<b>Double Pedestal Desk — Flush Top</b>	30 1/8"(765mm)	30"(762mm)	60"(1524mm)	ADRD-3060- <input type="checkbox"/> <input type="checkbox"/> <input type="checkbox"/> <input type="checkbox"/>	\$4746	\$4983
			66"(1676mm)	ADRD-3066- <input type="checkbox"/> <input type="checkbox"/> <input type="checkbox"/> <input type="checkbox"/>	4887	5131

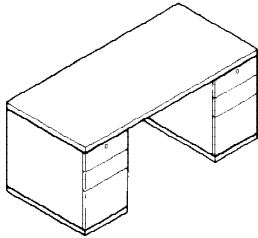

ADRD-3060  
ADRD-3066

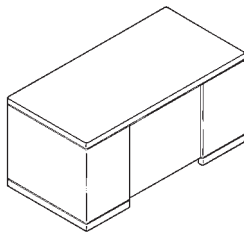

(Approach View)

- 30"(762mm) deep pedestals.
- Two locks standard, one for each pedestal.
- Top and modesty shipped unassembled.
- Accommodates separately-specified center pencil drawer, see page 151.
- Left- and right-hand grommets offer power access from top to floor through the inside cavity of the pedestal.

**To Order, Specify:**

- 1) Product number.
  - Specify edge detail as **9th digit** in product number.
    - 1** Classic
    - 2** Modern
    - 4** Traditional
  - Specify left pedestal configuration as **10th digit** in product number.
    - H** Box/box/file
    - J** File/file
  - Specify right pedestal configuration as **11th digit** in product number.
    - H** Box/box/file
    - J** File/file
  - Specify grommet option as **12th digit** in product number.
    - V** Left, add **\$83** list.
    - Z** Right, add **\$83** list.
    - Y** Center, add **\$83** list.
    - J** Left and right, add **\$166** list.
    - N** No grommet.
- 2) Reveal finish color.
- 3) Wood finish color (Anegre).
- 4) Grommet finish color (if applicable).

<b>Double Pedestal Desk — Overhang Top</b>	30 1/8"(765mm)	36"(914mm)	66"(1676mm)	ADOD-3666- <input type="checkbox"/> <input type="checkbox"/> <input type="checkbox"/> <input type="checkbox"/>	\$5178	\$5437
			72"(1829mm)	ADOD-3672- <input type="checkbox"/> <input type="checkbox"/> <input type="checkbox"/> <input type="checkbox"/>	5325	5591

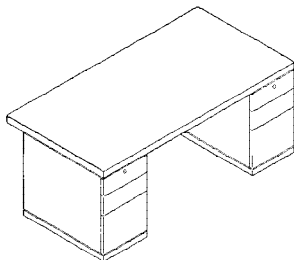

ADOD-3666  
ADOD-3672

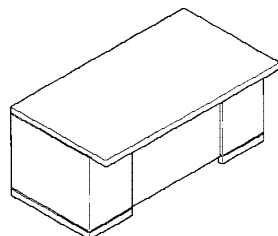

(Approach View)

- 30"(762mm) deep pedestals.
- 6"(152mm) overhang on approach side.
- Two locks standard, one for each pedestal.
- Top and modesty shipped unassembled.
- Accommodates separately-specified center pencil drawer, see page 151.
- Left- and right-hand grommets offer power access from top to floor through the inside cavity of the pedestal.

**To Order, Specify:**

- 1) Product number.
  - Specify edge detail as **9th digit** in product number.
    - 1** Classic
    - 2** Modern
    - 4** Traditional
  - Specify left pedestal configuration as **10th digit** in product number.
    - H** Box/box/file
    - J** File/file
  - Specify right pedestal configuration as **11th digit** in product number.
    - H** Box/box/file
    - J** File/file
  - Specify grommet option as **12th digit** in product number.
    - V** Left, add **\$83** list.
    - Z** Right, add **\$83** list.
    - Y** Center, add **\$83** list.
    - J** Left and right, add **\$166** list.
    - N** No grommet.
- 2) Reveal finish color.
- 3) Wood finish color (Anegre).
- 4) Grommet finish color (if applicable).

# Varia by SMED

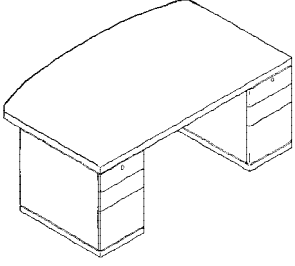
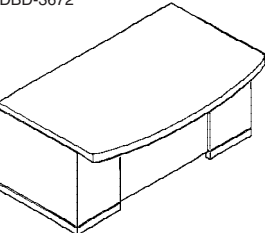
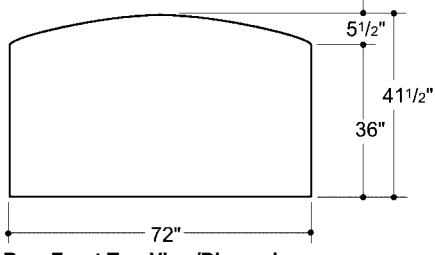
	Height	Depth	Width	Number	Wood Finish Group	
					3	4
<b>Double Pedestal Desk — Overhang Top with Bow Front</b>  ADBD-3672  (Approach View)	30 1/8"(765mm)	36"(914mm)	72"(1829mm)	ADBD-3672- <input type="checkbox"/> <input type="checkbox"/> <input type="checkbox"/> <input type="checkbox"/>	\$5775	\$6064
<ul style="list-style-type: none"> <li>• 30"(762mm) deep pedestals.</li> <li>• Two locks standard, one for each pedestal.</li> <li>• Chassis size: 30" x 72"(762mm x 1829mm).</li> <li>• Top and modesty shipped unassembled.</li> <li>• Accommodates separately-specified center pencil drawer, see page 151.</li> <li>• Left- and right-hand grommets offer power access from top to floor through the inside cavity of the pedestal.</li> </ul>  <p><b>Bow Front Top View/Dimensions</b></p>	<b>To Order, Specify:</b> <ol style="list-style-type: none"> <li>Product number.                              –Specify edge detail as <b>9th digit</b> in product number.                             <ul style="list-style-type: none"> <li><b>1</b> Classic</li> <li><b>2</b> Modern</li> <li><b>4</b> Traditional</li> </ul>                             –Specify left pedestal configuration as <b>10th digit</b> in product number.                             <ul style="list-style-type: none"> <li><b>H</b> Box/box/file</li> <li><b>J</b> File/file</li> </ul>                             –Specify right pedestal configuration as <b>11th digit</b> in product number.                             <ul style="list-style-type: none"> <li><b>H</b> Box/box/file</li> <li><b>J</b> File/file</li> </ul>                             –Specify grommet option as <b>12th digit</b> in product number.                             <ul style="list-style-type: none"> <li><b>V</b> Left, add <b>\$83</b> list.</li> <li><b>Z</b> Right, add <b>\$83</b> list.</li> <li><b>Y</b> Center, add <b>\$83</b> list.</li> <li><b>J</b> Left and right, add <b>\$166</b> list.</li> <li><b>N</b> No grommet.</li> </ul> </li> <li>Reveal finish color.</li> <li>Wood finish color (Anegre).</li> <li>Grommet finish color (if applicable).</li> </ol>					

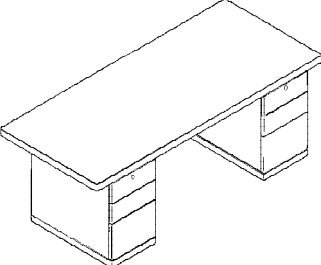
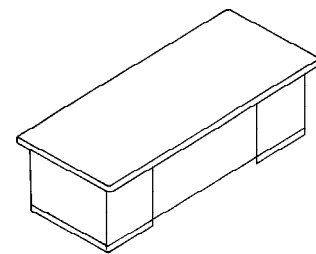
<b>Double Pedestal Desk — Executive Overhang</b>  ADED-3684  (Approach View)	30 1/8"(765mm)	36"(914mm)	84"(2134mm)	ADED-3684- <input type="checkbox"/> <input type="checkbox"/> <input type="checkbox"/> <input type="checkbox"/>	\$6025	\$6326
<ul style="list-style-type: none"> <li>• 30"(762mm) deep pedestals.</li> <li>• Top overhang on three sides.</li> <li>• Two locks standard, one for each pedestal.</li> <li>• Chassis size: 30" x 72"(762mm x 1829mm).</li> <li>• Top and modesty shipped unassembled.</li> <li>• Accommodates separately-specified center pencil drawer, see page 151.</li> <li>• Left- and right-hand grommets offer power access from top to floor through the inside cavity of the pedestal.</li> </ul>	<b>To Order, Specify:</b> <ol style="list-style-type: none"> <li>Product number.                              –Specify edge detail as <b>9th digit</b> in product number.                             <ul style="list-style-type: none"> <li><b>1</b> Classic</li> <li><b>2</b> Modern</li> <li><b>4</b> Traditional</li> </ul>                             –Specify left pedestal configuration as <b>10th digit</b> in product number.                             <ul style="list-style-type: none"> <li><b>H</b> Box/box/file</li> <li><b>J</b> File/file</li> </ul>                             –Specify right pedestal configuration as <b>11th digit</b> in product number.                             <ul style="list-style-type: none"> <li><b>H</b> Box/box/file</li> <li><b>J</b> File/file</li> </ul>                             –Specify grommet option as <b>12th digit</b> in product number.                             <ul style="list-style-type: none"> <li><b>V</b> Left, add <b>\$83</b> list.</li> <li><b>Z</b> Right, add <b>\$83</b> list.</li> <li><b>Y</b> Center, add <b>\$83</b> list.</li> <li><b>J</b> Left and right, add <b>\$166</b> list.</li> <li><b>N</b> No grommet.</li> </ul> </li> <li>Reveal finish color.</li> <li>Wood finish color (Anegre).</li> <li>Grommet finish color (if applicable).</li> </ol>					

# Varia by SMED

	Height	Depth	Width	Number	Wood Finish Group	
					3	4
<b>Double Pedestal Desk — Executive Overhang with Bow Front</b>	30 1/8"(765mm)	36"(914mm)	84"(2134mm)	ADHD-3684- <span style="display: inline-block; width: 15px; height: 15px; background-color: #ccc; border: 1px solid #000;"></span> <span style="display: inline-block; width: 15px; height: 15px; background-color: #ccc; border: 1px solid #000;"></span> <span style="display: inline-block; width: 15px; height: 15px; background-color: #ccc; border: 1px solid #000;"></span>	\$6475	\$6799

**Double Pedestal Desk — Executive Overhang with Bow Front**

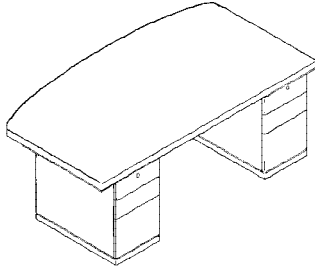

ADHD-3684

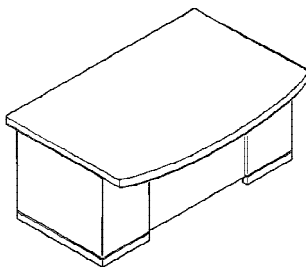

(Approach View)

- 30"(762mm) deep pedestals.
- Top overhang on three sides.
- Two locks standard, one for each pedestal.
- Chassis size: 30" x 72"(762mm x 1829mm).
- Top and modesty shipped unassembled.
- Accommodates separately-specified center pencil drawer, see page 151.
- Left- and right-hand grommets offer power access from top to floor through the inside cavity of the pedestal.

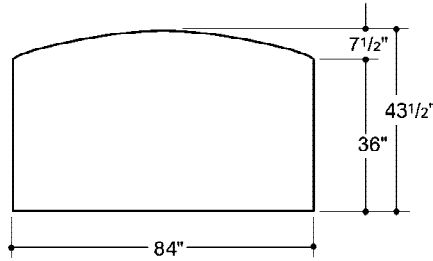

**Bow Front Top View/Dimensions**

**To Order, Specify:**

- Product number.
  - Specify edge detail as **9th digit** in product number.
    - 1** Classic
    - 2** Modern
    - 4** Traditional
  - Specify left pedestal configuration as **10th digit** in product number.
    - H** Box/box/file
    - J** File/file
  - Specify right pedestal configuration as **11th digit** in product number.
    - H** Box/box/file
    - J** File/file
  - Specify grommet option as **12th digit** in product number.
    - V** Left, add **\$83** list.
    - Z** Right, add **\$83** list.
    - Y** Center, add **\$83** list.
    - J** Left and right, add **\$166** list.
    - N** No grommet.
- Reveal finish color.
- Wood finish color (Anegre).
- Grommet finish color (if applicable).

# Varia by SMED

	Height	Depth	Width	Number	Wood Finish Group	
					3	4
<b>Single Pedestal Desk — Flush Top</b>	30 1/8"(765mm)	30"(762mm)	60"(1524mm)	ADRS-3060-	<b>\$4240</b>	<b>\$4452</b>
	30 1/8"(765mm)	30"(762mm)	66"(1676mm)	ADRS-3066-	<b>4378</b>	<b>4597</b>

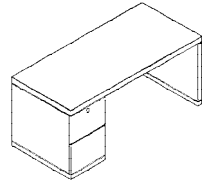

ADRS-3060  
ADRS-3066  
(Left pedestal shown)

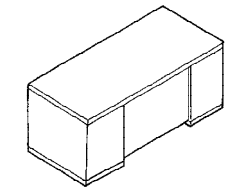

(Approach View)

- 30"(762mm) deep pedestal.
- One lock standard.
- Accommodates returns and bridges.
- Accommodates separately-specified center pencil drawer, see page 151.
- Left- and right-hand grommets offer power access from top to floor through the inside cavity of the pedestal.
- Top, end panels, and modesty shipped unassembled.

**To Order, Specify:**

- 1) Product number.
  - Specify edge detail as **9th digit** in product number.
    - 1** Classic
    - 2** Modern
    - 4** Traditional
  - Specify storage pedestal as **10th digit** in product number.
    - H** Box/box/file
    - J** File/file
  - Specify pedestal orientation as **11th digit** in product number.
    - L** Left-hand pedestal
    - R** Right-hand pedestal
  - Specify grommet option as **12th digit** in product number.
    - V** Left, add **\$83** list.
    - Z** Right, add **\$83** list.
    - Y** Center, add **\$83** list.
    - J** Left and right, add **\$166** list.
    - N** No grommet.
- 2) Reveal finish color.
- 3) Wood finish color (Anegre).
- 4) Grommet finish color (if applicable).

<b>Single Pedestal Desk with Overhang Top</b>	30 1/8"(765mm)	36"(914mm)	66"(1676mm)	ADOS-3666-	<b>\$4668</b>	<b>\$4901</b>
	30 1/8"(765mm)	36"(914mm)	72"(1829mm)	ADOS-3672-	<b>4830</b>	<b>5072</b>

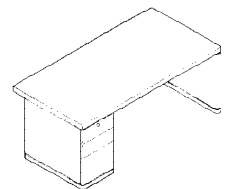

ADOS-3666  
ADOS-3672  
(Left pedestal shown)

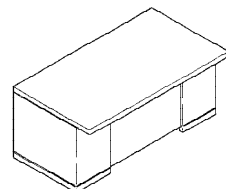

(Approach View)

- 30"(762mm) deep pedestal.
- One lock standard.
- Accommodates returns and bridges.
- Accommodates separately-specified center pencil drawer, see page 151.
- 6"(152mm) overhang on approach side.
- Left- and right-hand grommets offer power access from top to floor through the inside cavity of the pedestal.
- Top, end panels, and modesty shipped unassembled.

**To Order, Specify:**

- 1) Product number.
  - Specify edge detail as **9th digit** in product number.
    - 1** Classic
    - 2** Modern
    - 4** Traditional
  - Specify storage pedestal as **10th digit** in product number.
    - H** Box/box/file
    - J** File/file
  - Specify pedestal orientation as **11th digit** in product number.
    - L** Left-hand pedestal
    - R** Right-hand pedestal
  - Specify grommet option as **12th digit** in product number.
    - V** Left, add **\$83** list.
    - Z** Right, add **\$83** list.
    - Y** Center, add **\$83** list.
    - J** Left and right, add **\$166** list.
    - N** No grommet.
- 2) Reveal finish color.
- 3) Wood finish color (Anegre).
- 4) Grommet finish color (if applicable).

# Varia by SMED

	Height	Depth	Width	Number	Wood Finish Group	
					3	4
<b>Single Pedestal Desk — Overhang Top with Bow Front</b>	30 1/8"(765mm)	36"(914mm)	72"(1829mm)	ADBS-3672- <span style="display: inline-block; width: 15px; height: 15px; background-color: #ccc; border: 1px solid #000;"></span> <span style="display: inline-block; width: 15px; height: 15px; background-color: #ccc; border: 1px solid #000;"></span> <span style="display: inline-block; width: 15px; height: 15px; background-color: #ccc; border: 1px solid #000;"></span> <span style="display: inline-block; width: 15px; height: 15px; background-color: #ccc; border: 1px solid #000;"></span>	<b>\$5280</b>	<b>\$5544</b>

**Single Pedestal Desk — Overhang Top with Bow Front**

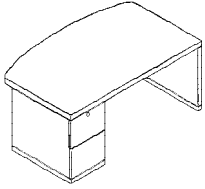

ADBS-3672  
(Left pedestal shown)

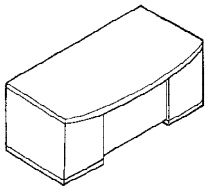

(Approach View)

- 30"(762mm) deep pedestal.
- One lock standard.
- Accommodates returns and bridges.
- Top, end panels, and modesty shipped unassembled.
- Accommodates separately-specified center pencil drawer, see page 151.
- Left- and right-hand grommets offer power access from top to floor through the inside cavity of the pedestal.

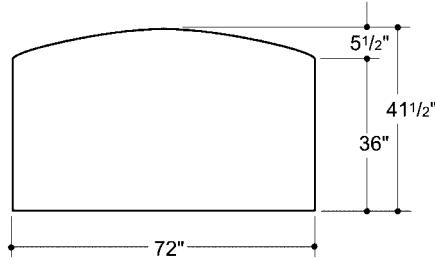

**Bow Front Top View/Dimensions**

**To Order, Specify:**

- 1) Product number.
  - Specify edge detail as **9th digit** in product number.
    - 1** Classic
    - 2** Modern
    - 4** Traditional
  - Specify storage pedestal as **10th digit** in product number.
    - H** Box/box/file
    - J** File/file
  - Specify pedestal orientation as **11th digit** in product number.
    - L** Left-hand pedestal
    - R** Right-hand pedestal
  - Specify grommet option as **12th digit** in product number.
    - V** Left, add **\$83** list.
    - Z** Right, add **\$83** list.
    - Y** Center, add **\$83** list.
    - J** Left and right, add **\$166** list.
    - N** No grommet.
- 2) Reveal finish color.
- 3) Wood finish color (Anegre).
- 4) Grommet finish color (if applicable).

# Varia by SMED

	Height	Depth	Width	Number	Wood Finish Group	
					3	4
<b>Return Shell</b>	30 1/8"(765mm)	20"(508mm)	42"(1067mm)	ARRH-2042- <input type="checkbox"/> <input type="checkbox"/> <input type="checkbox"/>	<b>\$1652</b>	<b>\$1735</b>
		24"(610mm)	42"(1067mm)	ARRH-2442- <input type="checkbox"/> <input type="checkbox"/> <input type="checkbox"/>	<b>2035</b>	<b>2137</b>
	30 1/8"(765mm)	20"(508mm)	48"(1219mm)	ARRH-2048- <input type="checkbox"/> <input type="checkbox"/> <input type="checkbox"/>	<b>\$1995</b>	<b>\$2095</b>
		24"(610mm)	48"(1219mm)	ARRH-2448- <input type="checkbox"/> <input type="checkbox"/> <input type="checkbox"/>	<b>2129</b>	<b>2235</b>
	30 1/8"(765mm)	20"(508mm)	66"(1676mm)	ARRH-2066- <input type="checkbox"/> <input type="checkbox"/> <input type="checkbox"/>	<b>\$2226</b>	<b>\$2337</b>
		24"(610mm)	66"(1676mm)	ARRH-2466- <input type="checkbox"/> <input type="checkbox"/> <input type="checkbox"/>	<b>2412</b>	<b>2533</b>

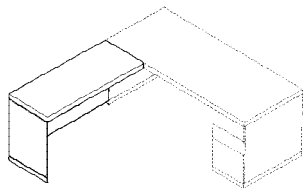

ARRH-2042-1LN  
ARRH-2442-1LN  
ARRH-2048-1LN  
ARRH-2448-1LN  
ARRH-2066-1LN  
ARRH-2466-1LN  
(Left-hand shown)

- Return shell with one end panel.
- Simulated pedestal on approach side.
- Attachment hardware included.
- Top, end panels, and modesty shipped unassembled.
- Accommodates separately-specified center pencil drawer on 24"(610mm) deep returns, see page 151.
- Returns ordered as left- or right-hand cannot be field reconfigured to the opposite orientation.

### To Order, Specify:

- Product number.
  - Specify edge detail as **9th digit** in product number.
    - 1** Classic
    - 2** Modern
    - 4** Traditional
  - Specify end panel as **10th digit** in product number.
    - L** Left-hand
    - R** Right-hand
  - Specify grommet option as **11th digit** in product number.
    - V** Left, add **\$83** list.
    - Z** Right, add **\$83** list.
    - Y** Center, add **\$83** list.
    - J** Left and right, add **\$166** list.
    - N** No grommet.
- Reveal finish color.
- Wood finish color (Anegre).
- Grommet finish color (if applicable).



# Varia by SMED

	Height	Depth	Width	Number	Wood Finish Group		
					3	4	
<b>Return with Pedestal</b>	30 1/8"(765mm)	20"(508mm)	42"(1067mm)	ARRS-2042-	■ ■ ■ ■ ■ ■ ■ ■	<b>\$2699</b>	<b>\$2834</b>
		24"(610mm)	42"(1067mm)	ARRS-2442-	■ ■ ■ ■ ■ ■ ■ ■	<b>3141</b>	<b>3298</b>
	30 1/8"(765mm)	20"(508mm)	48"(1219mm)	ARRS-2048-	■ ■ ■ ■ ■ ■ ■ ■	<b>\$3000</b>	<b>\$3150</b>
		24"(610mm)	48"(1219mm)	ARRS-2448-	■ ■ ■ ■ ■ ■ ■ ■	<b>3193</b>	<b>3353</b>
	30 1/8"(765mm)	20"(508mm)	66"(1676mm)	ARRS-2066-	■ ■ ■ ■ ■ ■ ■ ■	<b>\$3194</b>	<b>\$3354</b>
		24"(610mm)	66"(1676mm)	ARRS-2466-	■ ■ ■ ■ ■ ■ ■ ■	<b>3439</b>	<b>3611</b>

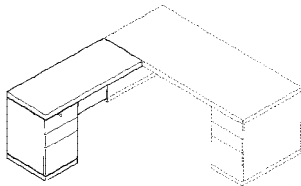

ARRS-2042-1HLFN  
 ARRS-2442-1HLFN  
 ARRS-2048-1HLFN  
 ARRS-2448-1HLFN  
 ARRS-2066-1HLFN  
 ARRS-2466-1HLFN  
 (Left-hand shown)

- Attaches to single pedestal desk or D-top desk.
- Attachment hardware included.
- One lock standard.
- Accommodates separately-specified center pencil drawer on 24"(610mm) deep returns, see page 151.
- Left- and right-hand grommets offer power access from top to floor through the inside cavity of the pedestal.
- Returns ordered as left- or right-hand cannot be field reconfigured to the opposite orientation.
- Returns shipped unassembled. Storage unit shipped assembled.

**To Order, Specify:**

- 1) Product number.
  - Specify edge detail as **9th digit** in product number.
    - 1** Classic
    - 2** Modern
    - 4** Traditional
  - Specify storage pedestal as **10th digit** in product number.
    - H** Box/box/file
    - J** File/file
  - Specify return orientation as **11th digit** in product number.
    - L** Left-hand
    - R** Right-hand
  - Specify modesty panel as **12th digit** in product number.
    - F** Full height modesty, add **\$365** list.
    - N** No modesty
  - Specify grommet option as **13th digit** in product number.
    - V** Left, add **\$83** list.
    - Z** Right, add **\$83** list.
    - Y** Center, add **\$83** list.
    - J** Left and right, add **\$166** list.
    - N** No grommet.
- 2) Reveal finish color.
- 3) Wood finish color (Anegre).
- 4) Grommet finish color (if applicable).

# Varia by SMED

	Height	Depth	Width	Number	Wood Finish Group	
					3	4
<b>Return with Lateral File</b>	30 1/8"(765mm)	20"(508mm)	66 "(1676mm)	ARRL-2066- L ■ ■ ■ ■	\$3751	\$3939
		24"(610mm)	66 "(1676mm)	ARRL-2466- L ■ ■ ■ ■	4080	4284

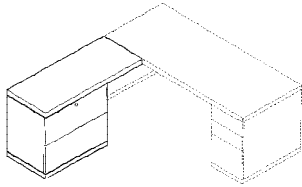

ARRL-2066  
ARRL-2466  
(Left-hand shown)

- Attaches to single pedestal desk or D-top desk.
- Attachment hardware included.
- One lock standard.
- 30"(762mm)lateral file.
- Returns shipped unassembled. Storage unit shipped assembled.
- Left- and right-hand grommets offer power access from top to floor through the inside cavity of the lateral file.
- Returns ordered as left- or right-hand cannot be field reconfigured to the opposite orientation.

**To Order, Specify:**

- 1) Product number.
  - Specify edge detail as **9th digit** in product number.
    - 1** Classic
    - 2** Modern
    - 4** Traditional
  - Specify return orientation as **11th digit** in product number.
    - L** Left-hand
    - R** Right-hand
  - Specify modesty panel as **12th digit** in product number.
    - F** Full height modesty, add \$365 list.
    - N** No modesty
  - Specify grommet option as **13th digit** in product number.
    - V** Left, add \$83 list.
    - Z** Right, add \$83 list.
    - Y** Center, add \$83 list.
    - J** Left and right, add \$166 list.
    - N** No grommet.
- 2) Reveal finish color.
- 3) Wood finish color (Anegre).
- 4) Grommet finish color (if applicable).

<b>Bridge</b>	30 1/8"(765mm)	20"(508mm)	42"(1067mm)	ABR-2042- ■ ■ ■ ■	\$1002	\$1052
						24"(610mm)
	20"(508mm)	48"(1219mm)	ABR-2048- ■ ■ ■ ■	1130	1187	
	24"(610mm)	48"(1219mm)	ABR-2448- ■ ■ ■ ■	1260	1323	

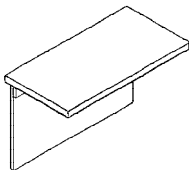

ABR-2042  
ABR-2442  
ABR-2048  
ABR-2448

- Attaches to single pedestal desk and corner unit or asymmetrical credenza to form a U-shaped configuration.
- Attachment hardware included.
- Accommodates separately-specified center pencil drawers on 24"(610mm) deep bridges, see page 151.
- Shipped unassembled.

**To Order, Specify:**

- 1) Product number.
  - Specify edge detail as **8th digit** in product number.
    - 1** Classic
    - 2** Modern
    - 4** Traditional
  - Specify modesty panel as **9th digit** in product number.
    - F** Full height modesty, add \$452 list.
    - N** No modesty
  - Specify grommet option as **10th digit** in product number.
    - Y** Center, add \$83 list.
    - N** No grommet.
- 2) Wood finish color (Anegre).
- 3) Grommet finish color (if applicable).

# Varia by SMED

	Height	Depth	Width	Number	Wood Finish Group	
					3	4
<b>D-Top Desk</b>	30 1/8"(765mm)	30"(762mm)	66"(1676mm)	ARED-3066-■	<b>\$2315</b>	<b>\$2431</b>
		36"(914mm)	72"(1829mm)	ARED-3672-■	<b>2927</b>	<b>3073</b>

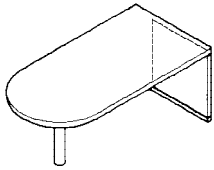

ARED-3672

- 6"(152mm) diameter cylinder base.
- Attachment hardware included.
- Attaches to a return or bridge only and cannot be specified as a freestanding desk.
- Accommodates separately-specified center pencil drawer, see page 151.
- End panel is always 30"(762mm) wide.
- 36"(914mm) deep top with 6"(152mm) overhang, mount end panel to left or right side.
- Shipped unassembled.

**To Order, Specify:**

- 1) Product number.  
–Specify edge detail as **9th digit** in product number.
  - 1** Classic
  - 2** Modern
  - 4** Traditional
- 2) Reveal finish color.
- 3) Wood finish color (Anegre).

<b>P-Top Desk</b>	30 1/8"(765mm)	30"(762mm)	72"(1829mm)	AREP-3072-■ ■	<b>\$3040</b>	<b>\$3192</b>
-------------------	----------------	------------	-------------	---------------	---------------	---------------

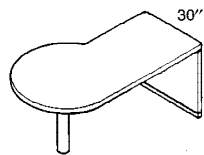

AREP-3072  
(Left-hand shown)

- Attaches to a return or bridge only and cannot be specified as a freestanding desk.
- 42"(1067mm) diameter conference end.
- 6"(152mm)-diameter cylinder base.
- 30"(762mm) width at square end.
- Accommodates separately-specified center pencil drawer, see page 151.
- Specify left- or right-hand configuration.
- Attachment hardware included.
- Shipped unassembled.

**To Order, Specify:**

- 1) Product number.  
–Specify edge detail as **9th digit** in product number.
  - 1** Classic
  - 2** Modern
  - 4** Traditional
 –Specify handedness as **10th digit** in product number.
  - L** Left-hand
  - R** Right-hand
- 2) Reveal finish color.
- 3) Wood finish color (Anegre).

# Varia by SMED

	Height	Depth	Width	Number	Wood Finish Group	
					3	4
<b>D-Top Convergent</b>	30 1/8"(765mm)	30"(762mm)	66"(1676mm)	ARND-3066-■	<b>\$2025</b>	<b>\$2126</b>
		36"(914mm)	72"(1829mm)	ARND-3672-■	<b>2637</b>	<b>2769</b>

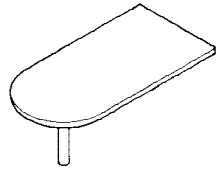

ARND-3066  
ARND-3672

- 6"(152mm)-diameter cylinder base.
- Convergent can be attached to a single pedestal desk or asymmetrical credenza.
- Accommodates separately-specified center pencil drawer, see page 151.
- Includes mounting hardware.
- Shipped unassembled.

**To Order, Specify:**

- 1) Product number.  
–Specify edge detail as **9th digit** in product number.
  - 1** Classic
  - 2** Modern
  - 4** Traditional
- 2) Wood finish color (Anegre).

<b>P-Top Convergent</b>	30 1/8"(765mm)	30"(762mm)	72"(1829mm)	ARNP-3072-■ ■	<b>\$2750</b>	<b>\$2888</b>
-------------------------	----------------	------------	-------------	---------------	---------------	---------------

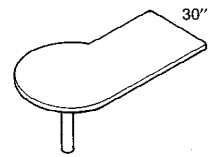

ARNP-3072  
(Left-hand shown)

- Convergent can be attached to a single pedestal desk or asymmetrical credenza.
- 42"(1067mm) diameter conference end.
- 6"(152mm) diameter cylinder base.
- 30"(762mm) width at square end.
- Accommodates separately-specified center pencil drawer, see page 151.
- Includes mounting hardware.
- Shipped unassembled.
- Specify left- or right-hand configuration.

**To Order, Specify:**

- 1) Product number.  
–Specify edge detail as **9th digit** in product number.
  - 1** Classic
  - 2** Modern
  - 4** Traditional
 –Specify handedness as **10th digit** in product number.
  - L** Left-hand
  - R** Right-hand
- 2) Wood finish color (Anegre).

# Varia by SMED

	Height	Depth	Width	Description	Number	Wood Finish Group	
						3	4
<b>Reception L-Desk</b>	42 3/4"(1085mm)	74 1/2(1891mm)	74 1/2"(1891mm)	Footprint	ATRL-7272- <span style="display: inline-block; width: 1em; height: 1em; background-color: #ccc; border: 1px solid #000;"></span> <span style="display: inline-block; width: 1em; height: 1em; background-color: #ccc; border: 1px solid #000;"></span> <span style="display: inline-block; width: 1em; height: 1em; background-color: #ccc; border: 1px solid #000;"></span> <span style="display: inline-block; width: 1em; height: 1em; background-color: #ccc; border: 1px solid #000;"></span> <span style="display: inline-block; width: 1em; height: 1em; background-color: #ccc; border: 1px solid #000;"></span>	\$12235	\$12847
	30 1/8"(765mm)	31 1/4"(793mm)	74 1/2"(1891mm)	Desk			
	30 1/8"(765mm)	25 1/4"(641mm)	43 1/4"(1098mm)	Return			

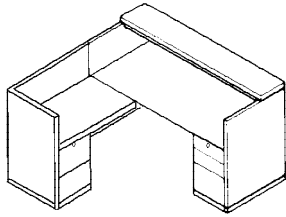

ATRL-7272-1JHLN  
(Left-hand return orientation)

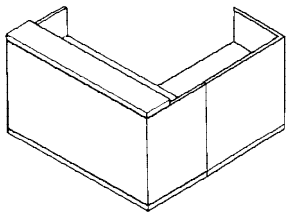

(Left-hand return approach view)

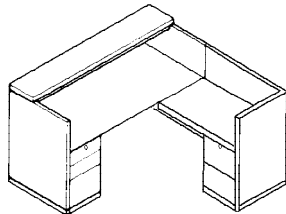

ATRL-7272-1HJRN  
(Right-hand return orientation)

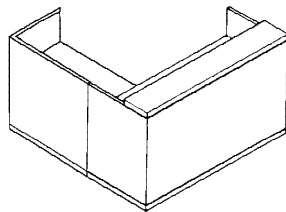

(Right-hand return approach view)

- One lock is standard on desk pedestal.
- Task light under transaction shelf is standard.
- Accommodates optional tackboard, see below.
- Transaction shelf depth is 12"(305mm), height is 44 3/8"(1127mm).
- Gallery panel height is 42 3/4"(1085mm).
- Galley walls, worksurfaces, and transition tops are shipped unassembled.
- Accommodates separately-specified center pencil drawer, see page 151.
- Left- and right-hand grommets offer power access from top to floor through the inside cavity of the pedestal.
- Pedestals are full depth.

**To Order, Specify:**

- Product number.
  - Specify edge detail as **9th digit** in product number.
    - 1** Classic
    - 2** Modern
    - 4** Traditional
  - Specify left pedestal configuration as **10th digit** in product number.
    - H** Box/box/file
    - J** File/file
  - Specify right pedestal configuration as **11th digit** in product number.
    - H** Box/box/file
    - J** File/file
  - Specify return orientation as **12th digit** in product number.
    - L** Left-hand
    - R** Right-hand
  - Specify grommet option as **13th digit** in product number.
    - V** Left on desk and pedestal end of return, add **\$166** list.
    - Z** Right on desk and pedestal end of return, add **\$166** list.
    - Y** Center on desk and pedestal end of return, add **\$166** list.
    - J** Left and right on desk and pedestal end of return, add **\$249** list.
    - N** No grommet.
- Reveal finish color.
- Wood finish color (Anegre).
- Grommet finish color (if applicable).
- Transaction shelf inset stone option color (if applicable), add **\$943** list.

**Reception L-Desk Tackboard**

Height	Description	Number	Fabric Grade		
			A	B	C
12 1/2"(318mm)	Attaches to 72"(1829mm) desk	ATTB-72	\$233	\$239	\$249



ATTB-72

- Mounts below transaction shelf.
- Requires field installation.
- COM yardage: 2.13.
- Tackboard ships as two pieces.

**To Order, Specify:**

- Product number.
- Fabric surface and color.

# Varia by SMED

	Height	Depth	Width	Description	Number	Wood Finish Group	
						3	4
<b>Reception U-Desk</b>	42 3/4"(1085mm)	74 1/2"(1891mm)	98 1/2"(2500mm)	Footprint	ATRU-7296-■ ■ ■ ■	\$16432	\$17254
	30 1/8"(765mm)	31 1/4"(793mm)	98 1/2"(2500mm)	Desk			
	30 1/8"(765mm)	25 1/4"(641mm)	43 1/4"(1098mm)	Return			

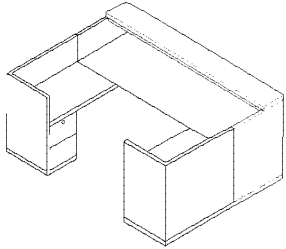

ATRU-7296-1JHN

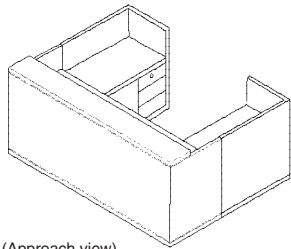

(Approach view)

- Task light under transaction shelf is standard.
- Accommodates optional tackboard, see below.
- Transaction shelf is 12"(305mm) deep; height is 44 3/8"(1127mm).
- Gallery panel height is 42 3/4"(1085mm).
- Galley walls, worksurfaces, and transition tops are shipped unassembled.
- Desk, bridge, and credenza shipped separately. Bridge shipped unassembled.
- Accommodates separately-specified center pencil drawer, see page 151.
- Left- and right-hand grommets offer power access from top to floor through the inside cavity of the pedestal.
- Pedestals are full depth.

**To Order, Specify:**

- Product number.
  - Specify edge detail as **9th digit** in product number.
    - 1** Classic
    - 2** Modern
    - 4** Traditional
  - Specify left pedestal configuration as **10th digit** in product number.
    - H** Box/box/file
    - J** File/file
  - Specify right pedestal configuration as **11th digit** in product number.
    - H** Box/box/file
    - J** File/file
  - Specify grommet option as **12th digit** in product number.
    - V** Left on desk and both ends of credenza, add \$249 list.
    - Z** Right on desk and both ends of credenza, add \$249 list.
    - Y** Center on desk and both ends of credenza, add \$249 list.
    - J** Left and right on desk and both ends of credenza, add \$332 list.
    - N** No grommet.
- Reveal finish color.
- Wood finish color (Anegre).
- Grommet finish color (if applicable).
- Transaction shelf inset stone option color (if applicable), add \$1316 list.

**Reception U-Desk Tackboard**



ATTB-96

Height	Description	Number	Fabric Grade		
			A	B	C
12 1/2"(318mm)	Attaches to 96"(2438mm) desk	ATTB-96	\$310	\$319	\$332

- Mounts below transaction shelf.
- Requires field installation.
- COM yardage: 2.75.
- Tackboard ships as two pieces.

**To Order, Specify:**

- Product number.
- Fabric surface and color.

# Varia by SMED

	Height	Depth	Width	Number	Wood Finish Group	
					3	4
<b>Credenza with Symmetrical Kneespace</b>	30 1/8"(765mm)	20"(508mm)	66"(1676mm)	ACSD-2066- <input type="checkbox"/> <input type="checkbox"/> <input type="checkbox"/> <input type="checkbox"/> <input type="checkbox"/> <input type="checkbox"/>	<b>\$3957</b>	<b>\$4155</b>
		24"(610mm)		ACSD-2466- <input type="checkbox"/> <input type="checkbox"/> <input type="checkbox"/> <input type="checkbox"/> <input type="checkbox"/> <input type="checkbox"/>	<b>4225</b>	<b>4436</b>
	30 1/8"(765mm)	20"(508mm)	72"(1829mm)	ACSD-2072- <input type="checkbox"/> <input type="checkbox"/> <input type="checkbox"/> <input type="checkbox"/> <input type="checkbox"/> <input type="checkbox"/>	<b>\$4059</b>	<b>\$4262</b>
		24"(610mm)		ACSD-2472- <input type="checkbox"/> <input type="checkbox"/> <input type="checkbox"/> <input type="checkbox"/> <input type="checkbox"/> <input type="checkbox"/>	<b>4381</b>	<b>4600</b>
	30 1/8"(765mm)	24"(610mm)		ACSD-2484- <input type="checkbox"/> <input type="checkbox"/> <input type="checkbox"/> <input type="checkbox"/> <input type="checkbox"/> <input type="checkbox"/>	<b>\$4527</b>	<b>\$4753</b>

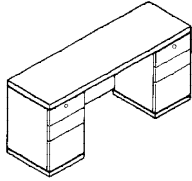

ACSD-2066-1HHFN  
 ACSD-2466-1HHFN  
 ACSD-2072-1HHFN  
 ACSD-2484-1HHFN

- Locks are standard, one for each pedestal.
- Accommodates vertical storage units.
- Left- and right-hand grommets offer power access from top to floor through the inside cavity of the pedestal.
- Top and modesty are shipped unassembled.
- Modesty panel is detachable for accessing wall power outlets and voice/data access ports.

**To Order, Specify:**

- Product number.
  - Specify edge detail as **9th digit** in product number.
    - 1** Classic
    - 2** Modern
    - 4** Traditional
  - Specify left hand storage pedestal as **10th digit** in product number.
    - H** Box/box/file
    - J** File/file
  - Specify right hand storage pedestal as **11th digit** in product number.
    - H** Box/box/file
    - J** File/file
  - Specify modesty panel as **12th digit** in product number.
    - F** Full height modesty, add **\$392** list.
    - N** No modesty
  - Specify grommet option as **13th digit** in product number.
    - Y** Center, add **\$83** list.
    - J** Left and right, add **\$166** list.
    - N** No grommet.
- Reveal finish color.
- Wood finish color (Anegre).
- Grommet finish color (if applicable).

# Varia by SMED

	Height	Depth	Width	Number	Wood Finish Group					
					3	4				
<b>Credenza with Asymmetrical Kneespace — Pedestal File</b>	30 1/8"(765mm)	20"(508mm)	66"(1676mm)	ACXS-2066-	<input type="checkbox"/>	<input type="checkbox"/>	<input type="checkbox"/>	<input type="checkbox"/>	\$3238	\$3400
		24"(610mm)		ACXS-2466-	<input type="checkbox"/>	<input type="checkbox"/>	<input type="checkbox"/>	<input type="checkbox"/>	3501	3676
	30 1/8"(765mm)	20"(508mm)	72"(1829mm)	ACXS-2072-	<input type="checkbox"/>	<input type="checkbox"/>	<input type="checkbox"/>	<input type="checkbox"/>	\$3340	\$3507
		24"(610mm)		ACXS-2472-	<input type="checkbox"/>	<input type="checkbox"/>	<input type="checkbox"/>	<input type="checkbox"/>	3657	3840
	30 1/8"(765mm)	24"(610mm)	84"(2134mm)	ACXS-2484-	<input type="checkbox"/>	<input type="checkbox"/>	<input type="checkbox"/>	<input type="checkbox"/>	\$3803	\$3993

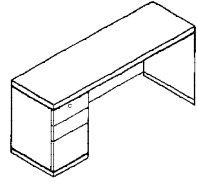

ACXS-2066-1HLN  
 ACXS-2466-1HLN  
 ACXS-2072-1HLN  
 ACXS-2472-1HLN  
 ACXS-2484-1HLN  
 (left shown)

- Lock is standard.
- Accommodates vertical storage units.
- Left- and right-hand grommets offer power access from top to floor through the inside cavity of the pedestal.
- Top, end panels, and modesty shipped unassembled.

**To Order, Specify:**

- 1) Product number.
  - Specify edge detail as **9th digit** in product number.
    - 1** Classic
    - 2** Modern
    - 4** Traditional
  - Specify storage pedestal as **10th digit** in product number.
    - H** Box/box/file
    - J** File/file
  - Specify pedestal orientation as **11th digit** in product number.
    - L** Left-hand pedestal
    - R** Right-hand pedestal
  - Specify grommet option as **12th digit** in product number.
    - Y** Center, add **\$83** list.
    - J** Left and right, add **\$166** list.
    - N** No grommet.
- 2) Reveal finish color.
- 3) Wood finish color (Anegre).
- 4) Grommet finish color (if applicable).



# Varia by SMED

	Height	Depth	Width	Number	Wood Finish Group	
					3	4
<b>Credenza with Asymmetrical Kneespace — Lateral File</b>	30 1/8"(765mm)	20"(508mm)	66"(1676mm)	ACXL-2066- L	\$3591	\$3760
		24"(610mm)		ACXL-2466- L	3925	4109
	30 1/8"(765mm)	20"(508mm)	72"(1829mm)	ACXL-2072- L	\$3793	\$3969
		24"(610mm)		ACXL-2472- L	4181	4376
	30 1/8"(765mm)	24"(610mm)	84"(2134mm)	ACXL-2484- L	\$4327	\$4529
			90"(2286mm)	ACXL-2490- L	4503	4714

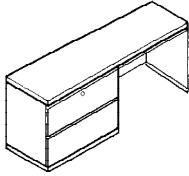

ACXL-2066-1LLN  
 ACXL-2466-1LLN  
 ACXL-2072-1LLN  
 ACXL-2472-1LLN  
 ACXL-2484-1LLN  
 ACXL-2490-1LLN  
 (left shown)

- Lock is standard.
- Accommodates vertical storage units.
- 30" wide lateral file unit standard for 66"(1676mm) width.
- 36" wide lateral file unit standard for 72"(1829mm), 84"(2134mm), and 90"(2286mm) width.
- Left- and right-hand grommets offer power access from top to floor through the inside cavity of the lateral file unit.
- Top, end panels, and modesty shipped unassembled.

**To Order, Specify:**

- 1) Product number.
  - Specify edge detail as **9th digit** in product number.
    - 1** Classic
    - 2** Modern
    - 4** Traditional
  - Specify storage orientation as **11th digit** in product number.
    - L** Left-hand
    - R** Right-hand
  - Specify grommet option as **12th digit** in product number.
    - Y** Center, add **\$83** list.
    - J** Left and right, add **\$166** list.
    - N** No grommet.
- 2) Reveal finish color.
- 3) Wood finish color (Anegre).
- 4) Grommet finish color (if applicable).

# Varia by SMED

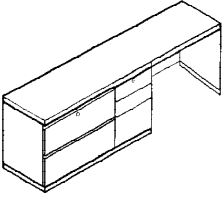
	Height	Depth	Width	Number	Wood Finish Group	
					3	4
<b>Credenza with Asymmetrical Kneespace — Lateral File/Pedestal</b>  ACXM-2490-1LHLN (left shown)	30 1/8"(765mm)	24"(610mm)	90"(2286mm)	ACXM-2490- L L L	\$5951	\$6234
<ul style="list-style-type: none"> <li>• Locks are standard, one for each pedestal and lateral file unit.</li> <li>• Accommodates vertical storage units.</li> <li>• 36"(914mm) wide lateral file unit standard.</li> <li>• Left- and right-hand grommets offer power access from top to floor through the inside cavity of the lateral file unit.</li> <li>• Top, end panels, and modesty shipped unassembled.</li> </ul>	<b>To Order, Specify:</b> 1) Product number. –Specify edge detail as <b>9th digit</b> in product number. 1 Classic 2 Modern 4 Traditional –Specify storage pedestal as <b>11th digit</b> in product number. H Box/box/file J File/file –Specify grommet option as <b>13th digit</b> in product number. Y Center, add \$83 list. J Left and right, add \$166 list. N No grommet. 2) Reveal finish color. 3) Wood finish color (Anegre). 4) Grommet finish color (if applicable).					

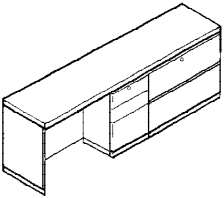
<b>Credenza with Asymmetrical Kneespace — Lateral File/Pedestal</b>  ACXM-2490-1HLRN (right shown)	30 1/8"(765mm)	24"(610mm)	90"(2286mm)	ACXM-2490- LR L	\$5951	\$6234
<ul style="list-style-type: none"> <li>• Locks are standard, one for each pedestal and lateral file unit.</li> <li>• Accommodates vertical storage units.</li> <li>• 36"(914mm) wide lateral file unit standard.</li> <li>• Left- and right-hand grommets offer power access from top to floor through the inside cavity of the lateral file unit.</li> <li>• Top, end panels, and modesty shipped unassembled.</li> </ul>	<b>To Order, Specify:</b> 1) Product number. –Specify edge detail as <b>9th digit</b> in product number. 1 Classic 2 Modern 4 Traditional –Specify storage pedestal as <b>10th digit</b> in product number. H Box/box/file J File/file –Specify grommet option as <b>13th digit</b> in product number. Y Center, add \$83 list. J Left and right, add \$166 list. N No grommet. 2) Reveal finish color. 3) Wood finish color (Anegre). 4) Grommet finish color (if applicable).					

# Varia by SMED

	Height	Depth	Width	Number	Wood Finish Group	
					3	4
<b>Credenza with Asymmetrical Kneespace — Double Hinged Door</b>	30 1/8"(765mm)	20"(508mm)	66"(1676mm)	ACXL-2066- D	\$3374	\$3543
		24"(610mm)		ACXL-2466- D	3684	3868
	30 1/8"(765mm)	20"(508mm)	72"(1829mm)	ACXL-2072- D	\$3526	\$3702
		24"(610mm)		ACXL-2472- D	3890	4085
	30 1/8"(765mm)	24"(610mm)	84"(2134mm)	ACXL-2484- D	\$4036	\$4238
			90"(2286mm)	ACXL-2490- D	4212	4423

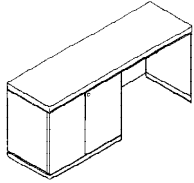

ACXL-2066-1DLN  
 ACXL-2466-1DLN  
 ACXL-2072-1DLN  
 ACXL-2472-1DLN  
 ACXL-2484-1DLN  
 ACXL-2490-1DLN  
 (left shown)

- Lock is standard.
- Accommodates vertical storage units.
- One adjustable shelf for each double door unit.
- Left- and right-hand grommets offer power access from top to floor through the inside cavity of the double door unit.
- Top, end panels, and modesty shipped unassembled.
- 30"(762mm) wide double door unit standard for 66"(1676mm) width.
- 36"(914mm) wide double door unit standard for 72"(1829mm), 84"(2134mm), and 90"(2286mm) width.

**To Order, Specify:**

- 1) Product number.  
 –Specify edge detail as **9th digit** in product number.
  - 1** Classic
  - 2** Modern
  - 4** Traditional
 –Specify storage orientation as **11th digit** in product number.
  - L** Left-hand
  - R** Right-hand
- 2) Reveal finish color.
- 3) Wood finish color (Anegre).
- 4) Grommet finish color (if applicable).

# Varia by SMED

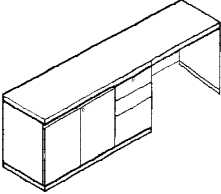
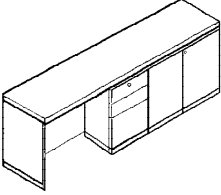
	Height	Depth	Width	Number	Wood Finish Group	
					3	4
<b>Credenza with Asymmetrical Kneespace — Double Hinged Door/ Pedestal</b>  <p>ACXM-2490-1DHLN (left shown)</p>	30 1/8"(765mm)	24"(610mm)	90"(2286mm)	ACXM-2490- D L	\$5660	\$5943
<ul style="list-style-type: none"> <li>• Locks are standard, one for each pedestal and double door unit.</li> <li>• Accommodates vertical storage units.</li> <li>• 36"(914mm) wide double door storage unit standard.</li> <li>• One adjustable shelf for each double door unit.</li> <li>• Left- and right-hand grommets offer power access from top to floor through the inside cavity of the double door unit.</li> <li>• Top, end panels, and modesty shipped unassembled.</li> </ul>	<b>To Order, Specify:</b> <ol style="list-style-type: none"> <li>1) Product number. —Specify edge detail as <b>9th digit</b> in product number. <ul style="list-style-type: none"> <li><b>1</b> Classic</li> <li><b>2</b> Modern</li> <li><b>4</b> Traditional</li> </ul> </li> <li>—Specify storage pedestal as <b>11th digit</b> in product number. <ul style="list-style-type: none"> <li><b>H</b> Box/box/file</li> <li><b>J</b> File/file</li> </ul> </li> <li>2) Reveal finish color.</li> <li>3) Wood finish color (Anegre).</li> <li>4) Grommet finish color (if applicable).</li> </ol>					
<b>Credenza with Asymmetrical Kneespace — Double Hinged Door/ Pedestal</b>  <p>ACXM-2490-1HDRN (right shown)</p>	30 1/8"(765mm)	24"(610mm)	90"(2286mm)	ACXM-2490- DR	\$5660	\$5943
<ul style="list-style-type: none"> <li>• Locks are standard, one for each pedestal and double door unit.</li> <li>• Accommodates vertical storage units.</li> <li>• 36"(914mm) wide double door storage unit standard.</li> <li>• One adjustable shelf for each double door unit.</li> <li>• Left- and right-hand grommets offer power access from top to floor through the inside cavity of the double door unit.</li> <li>• Top, end panels, and modesty shipped unassembled.</li> </ul>	<b>To Order, Specify:</b> <ol style="list-style-type: none"> <li>1) Product number. —Specify edge detail as <b>9th digit</b> in product number. <ul style="list-style-type: none"> <li><b>1</b> Classic</li> <li><b>2</b> Modern</li> <li><b>4</b> Traditional</li> </ul> </li> <li>—Specify storage pedestal as <b>10th digit</b> in product number. <ul style="list-style-type: none"> <li><b>H</b> Box/box/file</li> <li><b>J</b> File/file</li> </ul> </li> <li>2) Reveal finish color.</li> <li>3) Wood finish color (Anegre).</li> <li>4) Grommet finish color (if applicable).</li> </ol>					

# Varia by SMED

	Height	Depth	Width	Number	Wood Finish Group	
					3	4
<b>Credenza with Lateral File</b>	30 1/8"(765mm)	20"(508mm)	60"(1524mm)	ACFN-2060- L	\$4593	\$4801
		24"(610mm)		ACFN-2460- L	5003	5229
	30 1/8"(765mm)	20"(508mm)	72"(1829mm)	ACFN-2072- L	\$4965	\$5187
		24"(610mm)		ACFN-2472- L	5429	5671
30 1/8"(765mm)	24"(610mm)	90"(2286mm)	ACFN-2490- L	\$7423	\$7758	

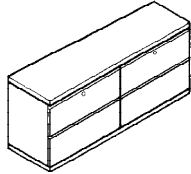

ACFN-2060-1L  
ACFN-2460-1L  
ACFN-2072-1L  
ACFN-2472-1L

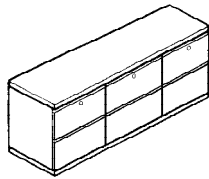

ACFN-2490-1L

- Locks are standard, one for each lateral file unit.
- Accommodates vertical storage units.
- 30"(762mm) wide lateral file unit standard for 60"(1524mm) and 90"(2286mm) width.
- 36"(914mm) wide lateral file unit standard for 72"(1829mm) width.
- Shipped assembled.

**To Order, Specify:**

- 1) Product number.  
–Specify edge detail as **9th digit** in product number.
 

<b>1</b>	Classic
<b>2</b>	Modern
<b>4</b>	Traditional
- 2) Reveal finish color.
- 3) Wood finish color (Anegre).

# Varia by SMED

	Height	Depth	Width	Number	Wood Finish Group	
					3	4
<b>Credenza with Lateral File and Two Pedestals</b>	30 1/8"(765mm)	20"(508mm)	66"(1676mm)	ACFM-2066- L	\$5680	\$5953
		24"(610mm)		ACFM-2466- L	6097	6390
	30 1/8"(765mm)	20"(508mm)	72"(1829mm)	ACFM-2072- L	\$5882	\$6163
		24"(610mm)		ACFM-2472- L	6353	6656

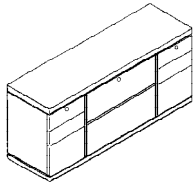

ACFM-2066-1HLH  
ACFM-2466-1HLH  
ACFM-2072-1HLH  
ACFM-2472-1HLH

- Locks are standard, one for each pedestal and lateral file unit.
- Accommodates vertical storage units.
- 30"(762mm) wide lateral file unit standard for 66"(1676mm) width.
- 36"(914mm) wide lateral file unit standard for 72"(1829mm) width.
- Shipped assembled.
- 1 5/8"(43mm) wood filler strips between pedestals and lateral file unit allows access to drawer pulls.

**To Order, Specify:**

- 1) Product number.  
–Specify edge detail as **9th digit** in product number.
  - 1** Classic
  - 2** Modern
  - 4** Traditional
 –Specify left hand storage pedestal as **10th digit** in product number.
  - H** Box/box/file
  - J** File/file
 –Specify right-hand storage pedestal as **12th digit** in product number.
  - H** Box/box/file
  - J** File/file
- 2) Reveal finish color.
- 3) Wood finish color (Anegre).

<b>Credenza with Double Hinged Door and Two Lateral Files</b>	30 1/8"(765mm)	24"(610mm)	90"(2286mm)	ACFM-2490- LDL	\$7182	\$7517
---	----------------	------------	-------------	----------------	--------	--------

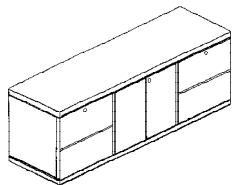

ACFM-2490-1LDL

- Locks are standard, one for each double door and lateral file unit.
- Accommodates vertical storage units.
- 30"(762mm) wide lateral file and double door units standard for 90"(2286mm) width.
- One adjustable shelf for each double door unit.
- Shipped assembled.
- 1 5/8"(43mm) wood filler strips between lateral file units and double door unit allows access to drawer pulls.

**To Order, Specify:**

- 1) Product number.  
–Specify edge detail as **9th digit** in product number.
  - 1** Classic
  - 2** Modern
  - 4** Traditional
- 2) Reveal finish color.
- 3) Wood finish color (Anegre).

# Varia by SMED

	Height	Depth	Width	Number	Wood Finish Group	
					3	4
<b>Credenza with Doors</b>	30 1/8"(765mm)	20"(508mm)	60"(1524mm)	ACFN-2060- D	\$4159	\$4367
		24"(610mm)		ACFN-2460- D	4521	4747
	30 1/8"(765mm)	20"(508mm)	72"(1829mm)	ACFN-2072- D	\$4431	\$4653
		24"(610mm)		ACFN-2472- D	4847	5089
	30 1/8"(765mm)	24"(610mm)	90"(2286mm)	ACFN-2490- D	\$6700	\$7035

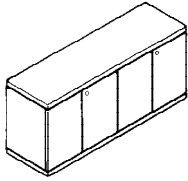

ACFN-2060-1D  
ACFN-2460-1D  
ACFN-2072-1D  
ACFN-2472-1D

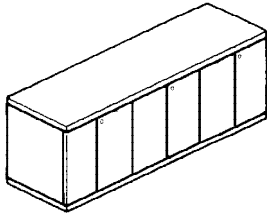

ACFN-2490-1D

- Locks are standard, one for each double door unit.
- Accommodates vertical storage units.
- One adjustable shelf for each double door unit.
- 30"(762mm) wide double door unit standard for 60"(1524mm) and 90"(2286mm) width.
- 36"(914mm) wide double door unit standard for 72"(1829mm) width.
- Shipped assembled.

**To Order, Specify:**

- 1) Product number.  
–Specify edge detail as **9th digit** in product number.
 

<b>1</b>	Classic
<b>2</b>	Modern
<b>4</b>	Traditional
- 2) Reveal finish color.
- 3) Wood finish color (Anegre).

# Varia by SMED

	Height	Depth	Width	Number	Wood Finish Group	
					3	4
<b>Credenza with Double Hinged Door and Two Pedestals</b>	30 1/8"(765mm)	20"(508mm)	66"(1676mm)	ACFM-2066- <input type="checkbox"/> <input type="checkbox"/> D <input type="checkbox"/>	<b>\$5463</b>	<b>\$5736</b>
		24"(610mm)		ACFM-2466- <input type="checkbox"/> <input type="checkbox"/> D <input type="checkbox"/>	<b>5856</b>	<b>6149</b>
	30 1/8"(765mm)	20"(508mm)	72"(1829mm)	ACFM-2072- <input type="checkbox"/> <input type="checkbox"/> D <input type="checkbox"/>	<b>\$5615</b>	<b>\$5896</b>
		24"(610mm)		ACFM-2472- <input type="checkbox"/> <input type="checkbox"/> D <input type="checkbox"/>	<b>6062</b>	<b>6365</b>

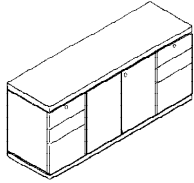

ACFM-2066-1HDH  
ACFM-2466-1HDH  
ACFM-2072-1HDH  
ACFM-2472-1HDH

- Locks are standard, one for each pedestal and double door unit.
- Accommodates vertical storage units.
- One adjustable shelf for each double door unit.
- 30"(762mm) wide double door unit standard for 66"(1676mm) width.
- 36"(914mm) wide double door unit standard for 72"(1829mm) width.
- Shipped assembled.

**To Order, Specify:**

- 1) Product number.  
–Specify edge detail as **9th digit** in product number.
  - 1 Classic
  - 2 Modern
  - 4 Traditional
 –Specify left hand storage pedestal as **10th digit** in product number.
  - H Box/box/file
  - J File/file
 –Specify right-hand storage pedestal as **12th digit** in product number.
  - H Box/box/file
  - J File/file
- 2) Reveal finish color.
- 3) Wood finish color (Anegre).

<b>Credenza with Lateral File and Two Double Hinged Door Units</b>	30 1/8"(765mm)	24"(610mm)	90"(2286mm)	ACFM-2490- <input type="checkbox"/> DLD	<b>\$6941</b>	<b>\$7276</b>
--	----------------	------------	-------------	---	---------------	---------------

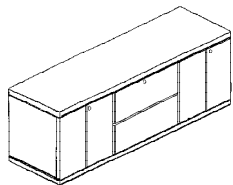

ACFM-2490-1DLD

- Locks are standard, one for each double door and lateral file unit.
- Accommodates vertical storage units.
- One adjustable shelf for each double door unit.
- 30"(762mm) wide lateral file unit and double door unit standard for 90"(2286mm) width.
- Shipped assembled.

**To Order, Specify:**

- 1) Product number.  
–Specify edge detail as **9th digit** in product number.
  - 1 Classic
  - 2 Modern
  - 4 Traditional
- 2) Reveal finish color.
- 3) Wood finish color (Anegre).



# Varia by SMED

	Height	Depth	Width	Description	Wood Finish Group		
					Number	3	4
<b>Corner Unit</b>	30 1/8"(765mm)	39 1/8"(994mm)	39 1/8"(994mm)	20"(508mm) left/20"(508mm) right	AUC-2020-	\$2584	\$2713
		43 1/8"(1096mm)	43 1/8"(1096mm)	24"(610mm) left/24"(610mm) right	AUC-2424-	2812	2953
		39 1/8"(994mm)	43 1/8"(1096mm)	20"(508mm) left/24"(610mm) right	AUC-2024-	2696	2831
		43 1/8"(1096mm)	39 1/8"(994mm)	24"(610mm) left/20"(508mm) right	AUC-2420-	2696	2831

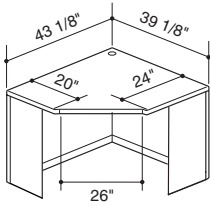

AUC-2024 (shown)

- Desk-height unit.
- Full-height back panels.
- One grommet standard in black.
- Accommodates separately-specified center pencil drawer, see page 151.
- Corner unit can be attached to a return or bridge.
- Edge detail on user side.
- 12"(305mm) end panel.
- Shipped unassembled.

**To Order, Specify:**

- 1) Product number.  
–Specify edge detail as **8th digit** in product number.
  - 1** Classic
  - 2** Modern
  - 4** Traditional
- 2) Reveal finish color.
- 3) Wood finish color (Anegre).

<b>VDT Table</b>	30 1/8"(765mm)	24 1/2"(622mm)	36"(914mm)		ASVD-2436-	\$2843	\$2985
------------------	----------------	----------------	------------	--	------------	--------	--------

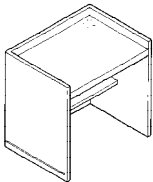

ASVD-2436

- 32"(813mm)H gallery, 29 1/2"(749mm)H worksurface.
- 16 3/4"(425mm)D shelf under worksurface.
- One grommet standard in black.
- Grommet size: 1 7/8"(48mm) in diameter.
- Edge detail on base.

**To Order, Specify:**

- 1) Product number.  
–Specify edge detail as **9th digit** in product number.
  - 1** Classic
  - 2** Modern
  - 4** Traditional
- 2) Reveal finish color.
- 3) Wood finish color (Anegre).

# Varia by SMED

	Height	Depth	Width	Number	Wood Finish Group	
					3	4
<b>Two-High Lateral File</b>	30 1/8"(765mm)	20"(508mm)	30"(762mm)	ASL2-2030-■	\$2394	\$2514
			36"(914mm)	ASL2-2036-■	2544	2671
	30 1/8"(765mm)	24"(610mm)	30"(762mm)	ASL2-2430-■	\$2671	\$2805
			36"(914mm)	ASL2-2436-■	2821	2962

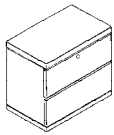

ASL2-2030  
ASL2-2036  
ASL2-2430  
ASL2-2436

- Two drawers with one front-mounted lock.
- Side-to-side and front-to-back filing capability.
- Anti-tilt mechanism.
- Shipped assembled.

**To Order, Specify:**

- 1) Product number.  
–Specify edge detail as **9th digit** in product number.
  - 1** Classic
  - 2** Modern
  - 4** Traditional
- 2) Reveal finish color.
- 3) Wood finish color (Anegre).

<b>Four-High Lateral File</b>	55 1/2"(1409mm)	20"(508mm)	30"(762mm)	ASL4-2030-■	\$4494	\$4719
			36"(914mm)	ASL4-2036-■	4794	5034
	55 1/2"(1409mm)	24"(610mm)	30"(762mm)	ASL4-2430-■	\$4987	\$5236
			36"(914mm)	ASL4-2436-■	5287	5551

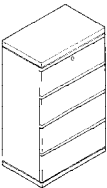

ASL4-2030  
ASL4-2036  
ASL4-2430  
ASL4-2436

- Four drawers with one front-mounted lock.
- Side-to-side and front-to-back filing capability.
- Anti-tilt mechanism.
- Shipped assembled.

**To Order, Specify:**

- 1) Product number.  
–Specify edge detail as **9th digit** in product number.
  - 1** Classic
  - 2** Modern
  - 4** Traditional
- 2) Reveal finish color.
- 3) Wood finish color (Anegre).

<b>Mobile Pedestal</b>	27 1/4"(692mm)	20"(508mm)	16 1/2"(415mm)	APM-2016-■ Q	\$2010	\$2111
------------------------	----------------	------------	----------------	--------------	--------	--------

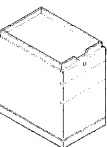

APM-2016

- Recessed casters.
- Standard with one front-mounted lock.
- Drawer configuration: pencil/box/file.
- Finished sides, top, and back.
- Shipped assembled.

**To Order, Specify:**

- 1) Product number.  
–Specify edge detail as **8th digit** in product number.
  - 1** Classic
  - 2** Modern
  - 4** Traditional
- 2) Reveal finish color.
- 3) Wood finish color (Anegre).

<b>Double Hinged Door</b>	30 1/8"(765mm)	20"(508mm)	30"(762mm)	ASDU-2030-■	\$2177	\$2286
			36"(914mm)	ASDU-2036-■	2277	2391
	30 1/8"(765mm)	24"(610mm)	30"(762mm)	ASDU-2430-■	2430	2552
			36"(914mm)	ASDU-2436-■	2530	2657

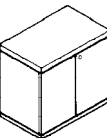

ASDU-2030  
ASDU-2036  
ASDU-2430  
ASDU-2436

- Standard with one front-mounted lock.
- One adjustable shelf for each double door unit.
- Shipped assembled.

**To Order, Specify:**

- 1) Product number.  
–Specify edge detail as **9th digit** in product number.
  - 1** Classic
  - 2** Modern
  - 4** Traditional
- 2) Reveal finish color.
- 3) Wood finish color (Anegre).

# Varia by SMED

	Height	Depth	Width	Number	Wood Finish Group	
					3	4
<b>Two-High Lateral File Open Bookcase</b>	72"(1829mm)	20"(508mm)	30"(762mm)	ASLB-2030-	\$4686	\$4920
		24"(610mm)	30"(762mm)	ASLB-2430-	4872	5116
	72"(1829mm)	20"(508mm)	36"(914mm)	ASLB-2036-	\$4836	\$5078
		24"(610mm)	36"(914mm)	ASLB-2436-	5022	5273

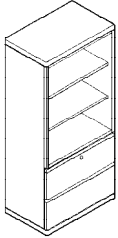

ASLB-2030  
ASLB-2430  
ASLB-2036  
ASLB-2436

- Two adjustable shelves:  
30" wide unit - 28 1/2"(724mm) wide x 18"(459mm) deep.  
36" wide unit - 34 1/2"(876mm) wide x 18"(459mm) deep.
- One lock standard.
- Shelves are adjustable in 1 1/4"(32mm) increments.
- Shipped assembled.

**To Order, Specify:**

- 1) Product number.  
–Specify edge detail as **9th digit** in product number.
  - 1** Classic
  - 2** Modern
  - 4** Traditional
- 2) Reveal finish color.
- 3) Wood finish color (Anegre).

<b>Two-High Lateral File Hinged Door Cabinet</b>	72"(1829mm)	20"(508mm)	30"(762mm)	ASLC-2030-	\$4983	\$5232
		24"(610mm)	30"(762mm)	ASLC-2430-	5192	5452
	72"(1829mm)	20"(508mm)	36"(914mm)	ASLC-2036-	\$5133	\$5390
		24"(610mm)	36"(914mm)	ASLC-2436-	5342	5609

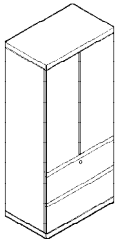

ASLC-2030  
ASLC-2430  
ASLC-2036  
ASLC-2436

- Two adjustable shelves:  
30" wide unit - 28 1/2"(724mm) wide x 18"(459mm) deep.  
36" wide unit - 34 1/2"(876mm) wide x 18"(459mm) deep.
- File drawer lock standard.
- Touch latch standard.
- Shipped assembled.

**To Order, Specify:**

- 1) Product number.  
–Specify edge detail as **9th digit** in product number.
  - 1** Classic
  - 2** Modern
  - 4** Traditional
- 2) Reveal finish color.
- 3) Wood finish color (Anegre).

<b>Hinged Door Cabinet Open Bookcase</b>	72"(1829mm)	20"(508mm)	30"(762mm)	ASDB-2030-	\$4453	\$4676
		24"(610mm)	30"(762mm)	ASDB-2430-	4605	4835
	72"(1829mm)	20"(508mm)	36"(914mm)	ASDB-2036-	\$4553	\$4781
		24"(610mm)	36"(914mm)	ASDB-2436-	4705	4940

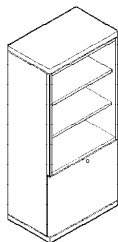

ASDB-2030  
ASDB-2430  
ASDB-2036  
ASDB-2436

- Three adjustable shelves:  
30" wide unit - 28 1/2"(724mm) wide x 18"(459mm) deep.  
36" wide unit - 34 1/2"(876mm) wide x 18"(459mm) deep.
- Unit has two adjustable shelves in bookcase portion; one adjustable shelf in the cabinet portion.
- Touch latch standard.
- One lock standard.
- Shelves are adjustable in 1 1/4"(32mm) increments.
- Shipped assembled.

**To Order, Specify:**

- 1) Product number.  
–Specify edge detail as **9th digit** in product number.
  - 1** Classic
  - 2** Modern
  - 4** Traditional
- 2) Reveal finish color.
- 3) Wood finish color (Anegre).

# Varia by SMED

	Height	Depth	Width	Number	Wood Finish Group	
					3	4
<b>Single Door Wardrobe</b>	72"(1829mm)	20"(508mm)	16 1/2"(415mm)	ASWS-2016- <input type="checkbox"/> <input type="checkbox"/>	<b>\$3829</b>	<b>\$4020</b>
		24"(610mm)	16 1/2"(415mm)	ASWS-2416- <input type="checkbox"/> <input type="checkbox"/>	<b>4227</b>	<b>4438</b>

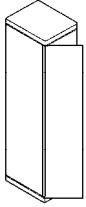

ASWS-2016-1L  
ASWS-2416-1L  
(left shown)

- Right or left hinged option.
- Hat shelf and hanger rod.
- Touch latch standard.
- Shipped assembled.

### To Order, Specify:

- 1) Product number.  
–Specify edge detail as **9th digit** in product number.
  - 1 Classic
  - 2 Modern
  - 4 Traditional
 –Specify wardrobe orientation as **10th digit** in product number.
  - L Left-hand hinge
  - R Right-hand hinge
- 2) Reveal finish color.
- 3) Wood finish color (Anegre).

<b>Single Door Storage Cabinet</b>	72"(1829mm)	20"(508mm)	16 1/2"(415mm)	ASCS-2016- <input type="checkbox"/> <input type="checkbox"/>	<b>\$3932</b>	<b>\$4129</b>
		24"(610mm)	16 1/2"(415mm)	ASCS-2416- <input type="checkbox"/> <input type="checkbox"/>	<b>4308</b>	<b>4523</b>

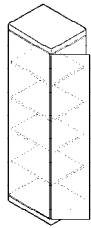

ASCS-2016-1L  
ASCS-2416-1L  
(left shown)

- Right or left hinged option.
- Four adjustable shelves.
- Touch latch standard.
- Shipped assembled.

### To Order, Specify:

- 1) Product number.  
–Specify edge detail as **9th digit** in product number.
  - 1 Classic
  - 2 Modern
  - 4 Traditional
 –Specify cabinet orientation as **10th digit** in product number.
  - L Left-hand hinge
  - R Right-hand hinge
- 2) Reveal finish color.
- 3) Wood finish color (Anegre).

# Varia by SMED

	Height	Depth	Width	Number	Wood Finish Group	
					3	4
<b>Double Door Wardrobe</b>	72"(1829mm)	20"(508mm)	30"(762mm)	ASWD-2030-█	\$5000	\$5250
		24"(610mm)	30"(762mm)	ASWD-2430-█	5527	5803
	72"(1829mm)	20"(508mm)	36"(914mm)	ASWD-2036-█	\$5100	\$5355
		24"(610mm)	36"(914mm)	ASWD-2436-█	5627	5908

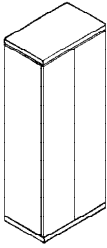

ASWD-2030  
ASWD-2430  
ASWD-2036  
ASWD-2436

- Hat shelf and hanger rod.
- Touch latch standard.
- Shipped assembled.

**To Order, Specify:**

- 1) Product number.  
–Specify edge detail as **9th digit** in product number.
  - 1** Classic
  - 2** Modern
  - 4** Traditional
- 2) Reveal finish color.
- 3) Wood finish color (Anegre).

<b>Double Door Wardrobe/ Storage Cabinet</b>	72"(1829mm)	20"(508mm)	30"(762mm)	ASWC-2030-█ █	\$5650	\$5933
		24"(610mm)	30"(762mm)	ASWC-2430-█ █	5846	6138
	72"(1829mm)	20"(508mm)	36"(914mm)	ASWC-2036-█ █	\$5750	\$6038
		24"(610mm)	36"(914mm)	ASWC-2436-█ █	5946	6243

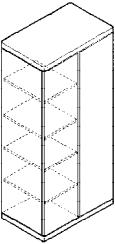

ASWC-2030-1R  
ASWC-2430-1R  
ASWC-2036-1R  
ASWC-2436-1R  
(right shown)

- Four adjustable shelves, wardrobe with hat shelf and hanger rod.
- Touch latch standard.
- Shipped assembled.

**To Order, Specify:**

- 1) Product number.  
–Specify edge detail as **9th digit** in product number.
  - 1** Classic
  - 2** Modern
  - 4** Traditional
 –Specify cabinet orientation as **10th digit** in product number.
  - L** Left-hand wardrobe
  - R** Right-hand wardrobe
- 2) Reveal finish color.
- 3) Wood finish color (Anegre).

<b>Double Door Storage Cabinet</b>	72"(1829mm)	20"(508mm)	30"(762mm)	ASCD-2030-█	\$5508	\$5783
		24"(610mm)	30"(762mm)	ASCD-2430-█	5677	5961
	72"(1829mm)	20"(508mm)	36"(914mm)	ASCD-2036-█	\$5608	\$5888
		24"(610mm)	36"(914mm)	ASCD-2436-█	5777	6066

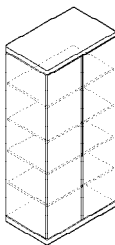

ASCD-2030  
ASCD-2430  
ASCD-2036  
ASCD-2436

- Four adjustable shelves.
- Touch latch standard.
- Shipped assembled.

**To Order, Specify:**

- 1) Product number.  
–Specify edge detail as **9th digit** in product number.
  - 1** Classic
  - 2** Modern
  - 4** Traditional
- 2) Reveal finish color.
- 3) Wood finish color (Anegre).

# Varia by SMED

	Height	Depth	Width	Number	Wood Finish Group	
					3	4
<b>Two-High Bookcase</b>	30 1/8"(765mm)	15"(381mm)	30"(762mm)	ASB2-1530-■	\$2491	\$2616
			36"(914mm)	ASB2-1536-■	2591	2721

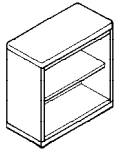

ASB2-1530  
ASB2-1536

- One adjustable shelf at 1 1/4"(32mm) increments.
- Accommodates one row of binders.
- Shipped assembled.

**To Order, Specify:**

- 1) Product number.  
–Specify edge detail as **9th digit** in product number.
  - 1** Classic
  - 2** Modern
  - 4** Traditional
- 2) Reveal finish color.
- 3) Wood finish color (Anegre).

<b>Five-High Bookcase</b>	72"(1829mm)	15"(381mm)	30"(762mm)	ASB5-1530-■	\$3812	\$4003
			30"(762mm)	ASB5-2030-■	4073	4277
	72"(1829mm)	15"(381mm)	36"(914mm)	ASB5-1536-■	\$3912	\$4108
			36"(914mm)	ASB5-2036-■	4173	4382

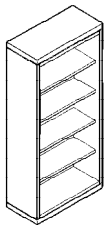

ASB5-1530  
ASB5-2030  
ASB5-1536  
ASB5-2036

- Four adjustable shelves at 1 1/4"(32mm) increments.
- Shipped assembled.

**To Order, Specify:**

- 1) Product number.  
–Specify edge detail as **9th digit** in product number.
  - 1** Classic
  - 2** Modern
  - 4** Traditional
- 2) Reveal finish color.
- 3) Wood finish color (Anegre).

<b>Radiused End Open Bookcase Deck</b>	41 7/8"(1064mm)	15"(381mm)	15"(381mm)	ASBE-1515-■	\$2745	\$2882
--	-----------------	------------	------------	-------------	--------	--------

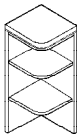

ASBE-1515

- Sits on radiused end cabinet, see below.
- Attached to unit of same finished height.
- Shipped assembled.

**To Order, Specify:**

- 1) Product number.  
–Specify edge detail as **9th digit** in product number.
  - 1** Classic
  - 2** Modern
  - 4** Traditional
- 2) Reveal finish color.
- 3) Wood finish color (Anegre).

<b>Single Door Radiused End Cabinet</b>	30 1/8"(765mm)	20"(508mm)	20"(508mm)	ASEC-2020-■ ■	\$2868	\$3011
		24"(610mm)	24"(610mm)	ASEC-2424-■ ■	3932	4129

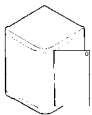

ASEC-2020-1L  
ASEC-2424-1L  
(left shown)

- Supports bookcase deck, see above.
- One adjustable shelf.
- Touch latch standard.
- Lock is standard.
- Shipped assembled.

**To Order, Specify:**

- 1) Product number.  
–Specify edge detail as **9th digit** in product number.
  - 1** Classic
  - 2** Modern
  - 4** Traditional
 –Specify cabinet orientation as **10th digit** in product number.
  - L** Left-hand
  - R** Right-hand
- 2) Reveal finish color.
- 3) Wood finish color (Anegre).

# Varia by SMED

	Height	Depth	Width	Description	Number	Wood Finish Group	
						3	4
<b>Overhead Bookcase - Wall Mount</b>	18 7/8"(480mm)	16 3/4"(425mm)	30"(762mm)	Open bookcase	ASOO-1630-■	<b>\$1427</b>	<b>\$1498</b>
			36"(914mm)	Open bookcase	ASOO-1636-■	<b>1527</b>	<b>1603</b>
			30"(762mm)	Hinged door bookcase	ASOD-1630-■ ■	<b>\$1685</b>	<b>\$1769</b>
			36"(914mm)	Hinged door bookcase	ASOD-1636-■ ■	<b>1785</b>	<b>1874</b>

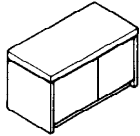

ASOO-1630  
ASOO-1636  
ASOD-1630  
ASOD-1636  
(Hinged door bookcase shown)

- Available open or with hinged doors.
- Top thickness is 1 1/4"(32mm) for any edge detail.
- Includes attachment hardware.
- No reveal available.
- Accommodates task light, see page 148.
- Lock is optional on hinged door bookcase.
- Shipped assembled.

**To Order, Specify:**

- Product number.
  - Specify edge detail as **9th digit** in product number.
    - 1** Classic
    - 2** Modern
    - 4** Traditional
  - Specify lock option as **10th digit** in product number.
    - K** Lock, add **\$150** list.
    - N** No lock
- Wood finish color (Anegre).

# Varia by SMED

	Height	Depth	Width	Description	Number	Wood Finish Group	
						3	4
<b>Upper Storage Bookcase Unit</b>	41 7/8"(1064mm)	15"(381mm)	30"(762mm)	Open storage	ASBF-1530-■	\$2238	\$2350
			36"(914mm)	Open storage	ASBF-1536-■	2338	2455

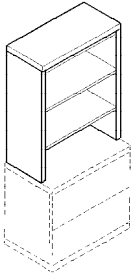

ASBF-1530  
ASBF-1536

- Attaches to 30"(762mm) and 36"(914mm) lateral file and double hinged door units.
- Two open, adjustable shelves.
- Does not accept tackboard.
- Shipped assembled.

### To Order, Specify:

- 1) Product number.  
–Specify edge detail as **9th digit** in product number.
  - 1** Classic
  - 2** Modern
  - 4** Traditional
- 2) Reveal finish color.
- 3) Wood finish color (Anegre).

## 66"(1676mm) Vertical Storage Unit

41 7/8"(1064mm)	15"(381mm)	66"(1676mm)	Open storage	AVFO-1566-■	\$3304	\$3469
			Hinged door storage	AVFD-1566-■ ■	3498	3673

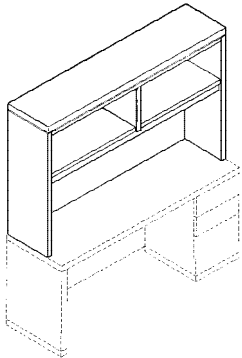

AVFO-1566 (shown)  
AVFD-1566

- Attaches to credenza top.
- Available open or four hinged doors.
- 22"(559mm) clearance from worksurface top to underside of vertical storage unit.
- Open storage units cannot be field converted to hinged door storage.
- Accommodates task light and tackboard, see pages 145 and 148.
- Locks are optional on hinged door storage.
- Shipped assembled.

### To Order, Specify:

- 1) Product number.  
–Specify edge detail as **9th digit** in product number.
  - 1** Classic
  - 2** Modern
  - 4** Traditional
- Specify lock option as **10th digit** in product number.
  - K** Lock, add \$300 list.
  - N** No lock
- 2) Reveal finish color.
- 3) Wood finish color (Anegre).

## 72"(1829mm) Vertical Storage Unit

41 7/8"(1064mm)	15"(381mm)	72"(1829mm)	Open storage	AVFO-1572-■	\$3825	\$4016
			Hinged door storage	AVFD-1572-■ ■	4500	4725

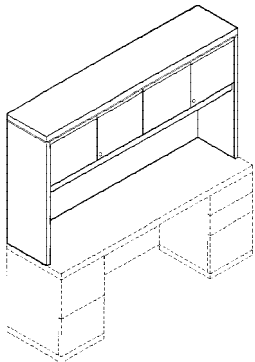

AVFO-1572  
AVFD-1572 (shown)

- Attaches to credenza top.
- Available open or four hinged doors. Hinged doors do not slide into case.
- 22"(559mm) clearance from worksurface top to underside of vertical storage unit.
- Open storage units cannot be field converted to hinged door storage.
- Accommodates task light and tackboard, see pages 145 and 148.
- Locks are optional on hinged door storage.
- Shipped assembled.

### To Order, Specify:

- 1) Product number.  
–Specify edge detail as **9th digit** in product number.
  - 1** Classic
  - 2** Modern
  - 4** Traditional
- Specify lock option as **10th digit** in product number.
  - K** Lock, add \$300 list.
  - N** No lock
- 2) Reveal finish color.
- 3) Wood finish color (Anegre).



# Varia by SMED

	Height	Depth	Width	Description	Number	Wood Finish Group	
						3	4
<b>84"(2134mm) Vertical Storage Unit</b>	41 7/8"(1064mm)	15"(381mm)	84"(2134mm)	Open storage	AVFO-1584-█	\$3776	\$3965
				Hinged door storage	AVFD-1584-█ █	4779	5018
<b>90"(2286mm) Vertical Storage Unit</b>	41 7/8"(1064mm)	15"(381mm)	90"(2286mm)	Open storage	AVFO-1590-█	\$4910	\$5156
				Hinged door storage	AVFD-1590-█ █	5896	6191

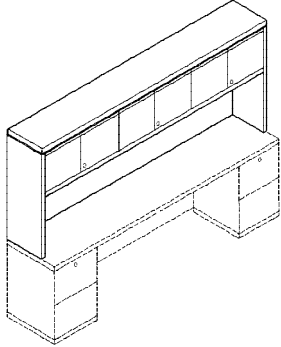

AVFO-1584  
AVFD-1584 (shown)

- Attaches to credenza top.
- Available open or six hinged doors.
- 22"(559mm) clearance from worksurface top to underside of Vertical Storage Unit valence.
- 84"(2134mm) Vertical Storage Unit accommodates task light and tackboard, see below and page 148.
- 90"(2286mm) Vertical Storage Unit accommodates task light and tackboard, see below and page 148.
- Open storage units cannot be field converted to hinged door storage.
- Locks are optional on hinged door storage.
- Shipped assembled.

**To Order, Specify:**

- Product number.  
-Specify edge detail as **9th digit** in product number.
  - 1** Classic
  - 2** Modern
  - 4** Traditional
 -Specify lock option as **10th digit** in product number.
  - K** Lock, add \$450 list.
  - N** No lock
- Reveal finish color.
- Wood finish color (Anegre).

**Vertical Storage Unit  
Tackboard**

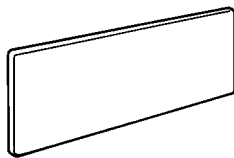

AVTF



Width	Height	Description	Number	Fabric Grade		
				A	B	C
63 1/2"(1612mm)	23 1/2"(597mm)	For 66"(1676mm) standard unit	AVTF-2466	\$250	\$256	\$266
69 1/2"(1765mm)		For 72"(1829mm) standard unit	AVTF-2472	310	316	326
81 1/2"(2070mm)		For 84"(2134mm) standard unit	AVTF-2484	362	371	384
87 1/2"(2222mm)		For 90"(2286mm) standard unit	AVTF-2490	400	409	422

- Mounts on standard Vertical Storage Unit.
- Requires field installation.
- COM yardage:
  - 63 1/2"(1612mm) tackboard - 2.0
  - 69 1/2"(1765mm) tackboard - 2.25
  - 81 1/2"(2070mm) tackboard - 2.33
  - 87 1/2"(2222mm) tackboard - 3.0
- 63 1/2"(1612mm) width tackboard ships as one piece.
- 69 1/2"(1765mm), 81 1/2"(2070mm), and 87 1/2"(2222mm) width tackboards ship as two pieces.

**To Order, Specify:**

- Product number.
- Fabric surface and color.

# Varia by SMED

	Height	Depth	Width	Description	Number	Wood Finish Group	
						3	4
<b>66"(1676mm) Combination Vertical Storage Unit</b>	41 7/8"(1064mm)	15"(381mm)	66"(1676mm)	Center open storage	AVSO-1566- 	\$5358	\$5626
				Center hinged door storage	AVSD-1566- 	5968	6266

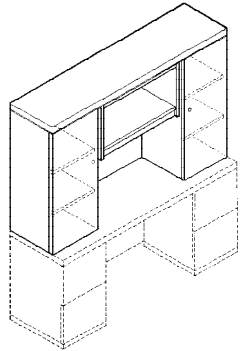



AVSO-1566 (shown)  
AVSD-1566

- Attaches to credenza top.
- Hinged door storage cabinet left and right with two adjustable shelves each.
- Upper center cabinet available open or hinged doors.
- 22"(559mm) clearance from worksurface top to underside of Vertical Storage Unit valence.
- Accommodates task light and tackboard, see pages 147-148.
- Lock option includes side storage and hinged doors if specified.
- Shipped assembled.

### To Order, Specify:

- 1) Product number.  
–Specify edge detail as **9th digit** in product number.
  - 1** Classic
  - 2** Modern
  - 4** Traditional
 –Specify lock option as **10th digit** in product number.
  - K** Lock, add \$300 list.
  - N** No lock
- 2) Reveal finish color.
- 3) Wood finish color (Anegre).

<b>72"(1829mm) Combination Vertical Storage Unit</b>	41 7/8"(1064mm)	15"(381mm)	72"(1829mm)	Center open storage	AVSO-1572- 	\$5619	\$5900
				Center hinged door storage	AVSD-1572- 	6204	6514

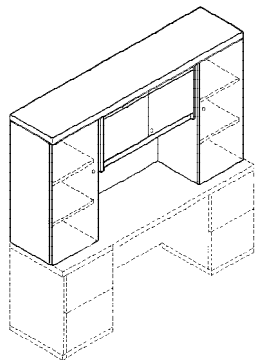



AVSO-1572  
AVSD-1572 (shown)

- Attaches to credenza top.
- Hinged door storage cabinet left and right with two adjustable shelves each.
- Upper center cabinet available open or hinged doors.
- 22"(559mm) clearance from worksurface top to underside of Vertical Storage Unit valence.
- Accommodates task light and tackboard, see pages 147-148.
- Lock option includes side storage and hinged doors if specified.
- Shipped assembled.

### To Order, Specify:

- 1) Product number.  
–Specify edge detail as **9th digit** in product number.
  - 1** Classic
  - 2** Modern
  - 4** Traditional
 –Specify lock option as **10th digit** in product number.
  - K** Lock, add \$300 list.
  - N** No lock
- 2) Reveal finish color.
- 3) Wood finish color (Anegre).

<b>84"(2134mm) Combination Vertical Storage Unit</b>	41 7/8"(1064mm)	15"(381mm)	84"(2134mm)	Center open storage	AVSO-1584- 	\$6118	\$6424
				Center hinged door storage	AVSD-1584- 	6793	7133

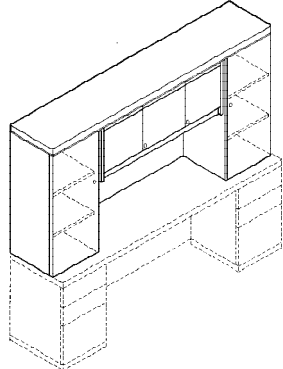

AVSO-1584  
AVSD-1584 (shown)

- Attaches to credenza top.
- Hinged door storage cabinet left and right with two adjustable shelves each.
- Upper center cabinet available open or hinged doors.
- 22"(559mm) clearance from worksurface top to underside of Vertical Storage Unit valence.
- Accommodates task light and tackboard, see pages 147-148.
- Lock option includes side storage and hinged doors if specified.
- Shipped assembled.

### To Order, Specify:

- 1) Product number.  
–Specify edge detail as **9th digit** in product number.
  - 1** Classic
  - 2** Modern
  - 4** Traditional
 –Specify lock option as **10th digit** in product number.
  - K** Lock, add \$300 list.
  - N** No lock
- 2) Reveal finish color.
- 3) Wood finish color (Anegre).

# Varia by SMED

	Height	Depth	Width	Description	Number	Wood Finish Group	
						3	4
<b>90"(2286mm) Combination Vertical Storage Unit</b>	41 7/8"(1064mm)	15"(381mm)	90"(2286mm)	Center open storage	AVSO-1590-■ ■	\$6604	\$6931
				Center hinged door storage	AVSD-1590-■ ■	7262	7625

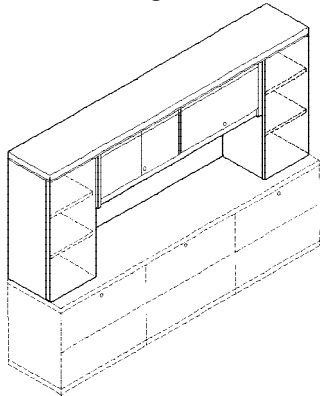

AVSO-1590  
AVSD-1590

- Attaches to credenza top.
- Hinged door storage cabinet left and right with two adjustable shelves each.
- Upper center cabinet available open or hinged doors.
- 22"(559mm) clearance from worksurface top to underside of Vertical Storage Unit valence.
- Lock option includes side storage and hinged doors if specified.
- Accommodates task light and tackboard, see below and page 148.
- Shipped assembled.

**To Order, Specify:**

- 1) Product number.  
–Specify edge detail as **9th digit** in product number.
  - 1** Classic
  - 2** Modern
  - 4** Traditional
 –Specify lock option as **10th digit** in product number.
  - K** Lock, add \$300 list.
  - N** No lock
- 2) Reveal finish color.
- 3) Wood finish color (Anegre).

**Combination Vertical Storage Unit Tackboard**

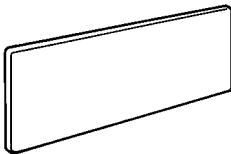

AVTS

Width	Height	Description	Number	Fabric Grade		
				A	B	C
33 1/8"(842mm)	23 1/2"(597mm)	For 66"(1676mm) unit	AVTS-2466	\$230	\$236	\$246
39 1/4"(995mm)		For 72"(1829mm) unit	AVTS-2472	290	296	306
51 1/8"(1300mm)		For 84"(2134mm) unit	AVTS-2484	342	348	358
57 1/8"(1452mm)		For 90"(2286mm) unit	AVTS-2490	380	386	396

- Mounts to Vertical Storage Unit.
- Requires field installation.
- COM yardage:
  - 33 1/8"(842mm) tackboard - 1.13
  - 39 1/4"(995mm) tackboard - 1.38
  - 51 1/8"(1300mm) tackboard - 1.63
  - 57 1/8"(1452mm) tackboard - 2.13
- Tackboards are one piece.

**To Order, Specify:**

- 1) Product number.
- 2) Fabric surface and color.

# Varia by SMED

	Height	Depth	Width	Description	Number	Price
<b>Fixed-Intensity Task Lighting (Wood Bottom Vertical Storage Unit)</b>	1 1/2"(38mm)	6 7/8"(175mm)	24.3"(617mm)		YHTL-0024-WT	<b>\$167</b>
			36.3"(922mm)		YHTL-0036-WT	<b>187</b>
			48.3"(1227mm)		YHTL-0048-WT	<b>195</b>
	1 1/2"(38mm)	6 7/8"(175mm)	24.3"(617mm)	Chicago task light	YHTL-0024-WTC	<b>\$220</b>
			36.3"(922mm)	Chicago task light	YHTL-0036-WTC	<b>252</b>
			48.3"(1227mm)	Chicago task light	YHTL-0048-WTC	<b>260</b>

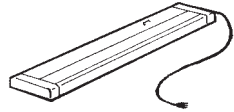

YHTL-0024-WT  
YHTL-0024-WTC

- Provides task lighting beneath overhead and vertical storage units.
- Task light width must be less than width of storage unit.
- Includes (1) set of mounting screws, lens, and cord to attach to wood bottom shelf of corner vertical storage unit.
- Nine-foot cord is factory-installed on right side; may be field-installed on left side.
- Units shipped with T-8 octic tri-phosphoric lamp with a 3500K color temperature.
- **For use with 120 volt 60 hertz electrical systems only.**

**To Order, Specify:**

- 1) Product number.  
(No finish specification required.)

Task Light Application Matrix			
Overhead Storage/ Vertical Storage Unit	24.3" Task Light	36.3" Task Light	48.3" Task Light
30" wide	1		
36" wide	1		
66" wide	2	1	1
72" wide	2	1	1
84" wide	3	2	1
90" wide	3	2	1

For full length lighting, (2) or (3) 24.3" wide task lights will mount under overhead storage units 66" wide and above. Additional combinations not exceeding the width of the overhead could be used.

Task Light Application Matrix			
Combination Vertical Storage Unit	24.3" Task Light	36.3" Task Light	48.3" Task Light
66" wide	1		
72" wide	1	1	
84" wide	1	1	1
90" wide	2	1	1

# Varia by SMED

	Height	Depth	Width	Number	Wood Finish Group	
					3	4

**Lectern**

48"(1219mm)	20"(508mm)	36"(914mm)	AFL-2036-	\$4909	\$5154
-------------	------------	------------	-----------	--------	--------

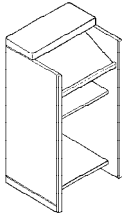

AFL-2036

- Sloped upper shelf and reading light.
- Fixed book shelf and lower shelf.
- Three grommets through sloped surface and lower two shelves.
- Grommet size: 1 7/8"(48mm) in diameter.
- One grommet standard in black.

**To Order, Specify:**

- 1) Product number.  
–Specify edge detail as **8th digit** in product number.
  - 1** Classic
  - 2** Modern
  - 4** Traditional
- 2) Reveal finish color.
- 3) Wood finish color (Anegre).

**Serving Cart**

30 1/2"(775mm)	20"(508mm)	36"(914mm)	AFS-2036-	\$4304	\$4519
----------------	------------	------------	-----------	--------	--------

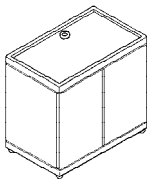

AFS-2036

- Casters with side hinged doors and adjustable shelf.
- Black plastic laminate top.
- Black handle.
- Equipped with two electrical outlets and retractable cord reel.
- Two grommets: worksurface and lower right-hand corner of right end panel.
- Grommet size: 1 7/8"(48mm) in diameter.
- One grommet standard in black.
- Shipped assembled.

**To Order, Specify:**

- 1) Product number.  
–Specify edge detail as **8th digit** in product number.
  - 1** Classic
  - 2** Modern
  - 4** Traditional
- 2) Reveal finish color.
- 3) Wood finish color (Anegre).

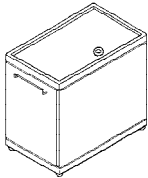

Back view

**Presentation Board**

50 1/2"(1282mm)	3 3/8"(86mm)	48"(1219mm)	AAVD-4848-	Wood Finish Group	Fabric Grade		
				3	A	B	C
				3	\$3967	\$3977	\$3993
				4	4165	4175	4191

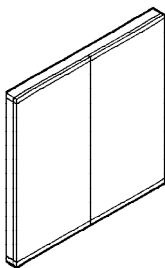

AAVD-4848

- Double-hinged doors with fabric covered tackboards equipped with flipchart pins.
- Standard with flip chart (mounted over tackboard) convertible left or right.
- Retractable projection screen.
- Writing surface.
- Two touch latches standard.
- Lock not available.
- COM yardage: 1.25.
- Wall mounting hardware included.
- Shipped assembled.

**To Order, Specify:**

- 1) Product number.  
–Specify edge detail as **9th digit** in product number.
  - 1** Classic
  - 2** Modern
  - 4** Traditional
- 2) Wood finish color (Anegre).
- 3) Fabric finish color.

# Varia by SMED

	Height	Depth	Width	Number	Wood Finish Group	
					3	4

### Telephone Stand

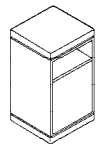

AFT-1516

30 1/8"(765mm) 15"(381mm) 16 1/2"(415mm)

AFT-1516-  \$2475 \$2599

- Side hinged door and open fixed shelf.
- Door hinged left and opens left.
- Touch latch standard.
- Shelf dimension: 14 1/4"(362mm)D, 14 7/8"(378mm)W, 6 1/4"(156mm)H
- Inside dimension: 13 1/2"(343mm)D, 14 7/8"(378mm)W, 16 5/8"(422mm)H.
- Shipped assembled.

#### To Order, Specify:

- 1) Product number.  
–Specify edge detail as **8th digit** in product number.
  - 1 Classic
  - 2 Modern
  - 4 Traditional
- 2) Reveal finish color.
- 3) Wood finish color (Anegre).

### Video Cabinet

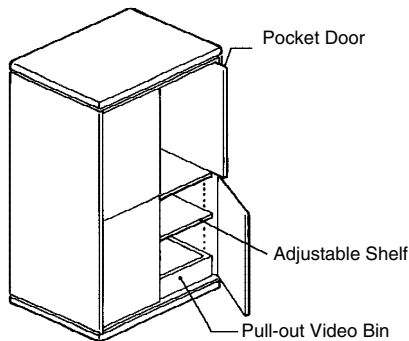

AFV-5536

55 1/2"(1409mm) 24"(610mm) 36"(914mm)

AFV-5536-  \$5757 \$6045

- Unit is on casters with four side-hinged doors on front.
- Top doors open 90° and recess into case.
- Lower cabinet has one adjustable shelf and videocassette storage bins in a pull-out shelf.
- Equipped with two electrical outlets and retractable cord reel.
- Two locks and casters are standard.
- Shipped assembled.
- Television dimensions: 22 1/8"(563mm)D, 29 5/8"(752mm)W, 24 3/4"(628mm)H.

#### To Order, Specify:

- 1) Product number.  
–Specify edge detail as **8th digit** in product number.
  - 1 Classic
  - 2 Modern
  - 4 Traditional
- 2) Reveal finish color.
- 3) Wood finish color (Anegre).

72"(1829mm) 24"(610mm) 36"(914mm)

AFV-7236-  \$7323 \$7689

- Unit has four side-hinged doors on front.
- Top doors open 90° and recess into case.
- Upper section provides vertical clearance for VCR, pull-out travel/swivel 15° shelf for monitor, and 6-outlet electrical strip with 67" cord.
- Lower cabinet provides two adjustable shelves, videocassette bins in pull-out shelf, and a cord grommet in back panel.
- Two locks standard.
- Shipped assembled.

#### To Order, Specify:

- 1) Product number.  
–Specify edge detail as **8th digit** in product number.
  - 1 Classic
  - 2 Modern
  - 4 Traditional
- 2) Reveal finish color.
- 3) Wood finish color (Anegre).

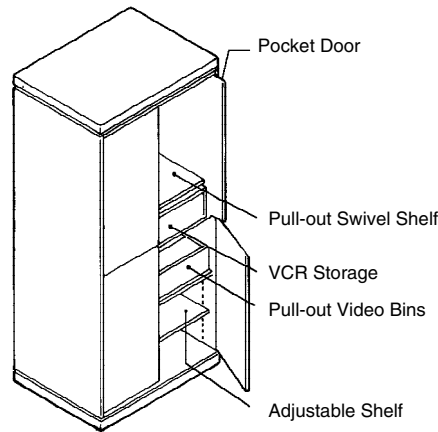

AFV-7236

# Varia by SMED

	Height	Depth	Width	Number	Price
--	--------	-------	-------	--------	-------

**Center Pencil Drawer**

17 5/8"(448mm)      19 1/2"(495mm)

AACD-1820

\$235

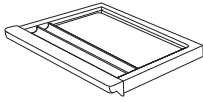

- Drawer and pencil tray construction is red oak. Front rail is Agathis solid, matching Anegre finish.
- Includes a hardwood pencil tray.
- Not available on 20"(508mm)-deep units.

**To Order, Specify:**

- 1) Product number.
- 2) Wood finish color (Anegre).

AACD-1820  
Class QA

**Pencil Tray**

AAPT-1

\$ 82

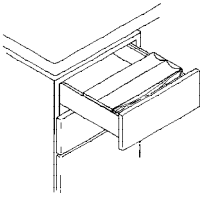

- Solid red oak.
- Fits into box drawer.

**To Order, Specify:**

- 1) Product number.  
(No finish specification required.)

AAPT-1  
Class QA

**Keyboard Pullout Tray**

3 3/16"(81mm)      18 7/8"(479mm)      22 1/2"(572mm)

L-KT

\$356

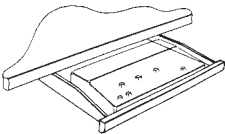

- Accommodates up to a 10"(254mm) deep x 20 1/4"(514mm) wide x 2 1/2"(64mm) high keyboard.
- Solid wood frame with charcoal bottom.

**To Order, Specify:**

- 1) Product number.
- 2) Wood finish color.

L-KT  
Class RA

**Adjustable Keyboard Pad**

3 1/2"(89mm)      5 3/4"-9"(146mm-229mm)      17"-22"(432mm-559mm)

L-AKP-3

\$450

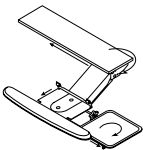

- Includes adjustable keyboard pad and palm rest.
- Spring assisted mechanism tilts, raises, lowers and has dual swivel complete with adjustable palm rest.
- Mouse pad swivels, tilts, and is interchangeable between right and left hand applications.

**To Order, Specify:**

- 1) Product number.  
(No finish specification required.)

L-AKP-3  
Class RA

**Wrist Support**

1"(25mm)      2 1/2"(64mm)      27 3/4"(705mm)

L-LPR-2

\$ 89

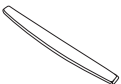



- Gel interior.
- Standard in black finish color only.
- Covers keyboard and mouse area.

**To Order, Specify:**

- 1) Product number.  
(No finish specification required.)

L-LPR-2  
Class RA

# Varia by SMED

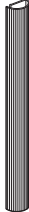
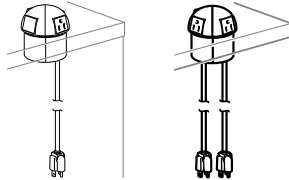
	Description	Number	Price
 AAG-1 Class QA	Field-installed	AAG-1	\$32
	<ul style="list-style-type: none"> <li>Available in two finishes (black or brass).</li> <li>Inside diameter of grommet is 1 3/4"(46mm).</li> </ul>	<b>To Order, Specify:</b> 1) Product number. 2) Finish color.	
 L-WMT Class RA	Horizontal	L-WMT	\$37
	Vertical	CPVC-1	25
 CPVC-1 Class RA	<ul style="list-style-type: none"> <li>Secures to the inside kneewell of casegoods.</li> <li>Requires field installation.</li> </ul>	<b>To Order, Specify:</b> 1) Product number. (No finish specification required.)	
	Two (2) power outlets and two (2) plates for data connections	OLTD-2	\$144
 OLTD-2 Class RA	Four (4) power outlets	OLTD-4	158
	<ul style="list-style-type: none"> <li>Provides power and communication access at desk top height.</li> <li>Mounts into a field-cut 3"(76mm) diameter hole.</li> <li>Standard in black finish color only.</li> <li>OLTD-2 accepts category 3 connection hardware.</li> <li>OLTD-2 includes one (1) 72"(1829mm) long power cord and 15-amp plug. OLTD-4 includes two (2) 72"(1829mm) long power cords and 15-amp plugs.</li> <li>Requires field installation.</li> </ul>	<b>To Order, Specify:</b> 1) Product number. (No finish specification required.)	
YALF-15 Class RB	15" deep lateral file front to back hanging bar	YALF-15	\$15
	30" wide lateral file side to side wood hanging bar	TALW-30	23
	36" wide lateral file side to side wood hanging bar	TALW-36	23
	<ul style="list-style-type: none"> <li>Black trim color.</li> </ul>	<b>To Order, Specify:</b> 1) Product number. (No finish specification required.)	



# Nottingham

**Product Offering**

The Nottingham product offering consists of the following:

Table Desks	U-Stations
Double Pedestal Desks	Credenzas
Single Pedestal Desks	Lateral Files
Returns	Freestanding Bookcases
Bridges	Vertical Storage Units
Corner Units	Computer Support Units
L-Desks	

**Construction Features**

Nottingham casegoods feature walnut veneer surfaces and solid walnut edges. A wood-grain plastic laminate top is available on select casegoods with solid walnut edges.

All drawers feature antique finished brass hardware.

Drawer front, back and sides are constructed of 5 ply laminated plywood drawer boxes with oak veneer on all sides. Drawer corners are dowelled and glued for superior strength. A solid wood pencil tray is standard in center pencil drawers. Drawer fronts are attached to a separate drawer body assembly.

Drawer slides feature ball-bearing construction for smooth and quiet action. File and lateral file drawers utilize heavy duty full-extension slides. Box drawers utilize 3/4-extension slides.

Adjustable floor glides are standard on all Nottingham casegoods.

**Wire Management**

A center-mounted grommet is standard on kneespace credenzas, desk-height returns, bridges, and corner units. Machine-height returns include a standard left or right grommet. The VDT table has a continuous wireway along the top of the modesty panel, left and right grommets in the top, and a wireway cutout in each corner of the lower shelf. Vertical storage units have either one grommet in the bottom center of an open vertical storage unit, or four grommets in the back panel of the four door unit. Optional grommets may be specified as left, right, or left and right on all double pedestal and single pedestal desks, and as left, right, left and right, or center on single and double pedestal credenzas.

Optional grommets may be specified as left or right on all double pedestal and single pedestal desks, and as left, center, or right on single and double pedestal credenzas.

**Lock Program**

A central locking mechanism is standard on all desks, credenzas, and lateral files. Vertical storage unit doors, returns, and 24" x 49" (610mm x 1245mm) single pedestal desks are not equipped with locks.

**Wood/Finish Features**

All Nottingham casegoods are fabricated with the highest grade walnut veneers, solid walnut edges and molding. Base rails are solid hardwood.

All exposed veneers are plain-sliced and book-matched.

Drawer-fronts are matched in sets for consistent grain and color.

Nottingham casegoods feature mostly filled walnut finishes, sprayed with two layers of catalyzed lacquer. Tops are hand rubbed to a high sheen for a rich, durable, high-gloss look.

To keep your wood writing surfaces looking beautiful for the life of the product, it is highly recommended that a blotter pad, glass or plexiglass be used under writing instruments.

Laminate is available on tops, and is recommended for severe use applications.

**Edge Detail**

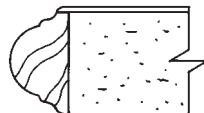

# Nottingham

## General Guidelines For Product Specification

Nottingham product specification numbers are based on an alpha-numeric logic which identifies a product by product line, size and certain characteristics.

For instance, a product number that reads **OTDO-3672** identifies the product as a Nottingham double pedestal desk, 36"(914mm) deep and 72"(1829mm) wide with an overhang top.

The alpha-numeric logic for a Nottingham double pedestal desk with Walnut veneer and Dover finish color is shown below:

The numeric logic for this model with finish codes is shown below:

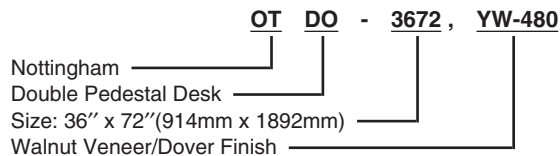

A ninth character of the product number will indicate options, such as -L for left-hand configuration or -R for right-hand configuration.

There are exceptions to this logic; therefore, always refer to the price charts for product numbers rather than attempting to construct them. Product number modification instructions for additional options appear in footnoted copy for each applicable product.

Beyond the printed product number, wood finish color and optional surface finish color codes are required to complete an order specification. To communicate your order clearly, list the product number, finish codes, and options in the sequence outlined on each price page.

## Finishes

A complete listing of finishes and fabrics for Nottingham casegoods can be found on pages 207-211.

# Nottingham

	Height	Depth	Width	Description	Number	Price
--	--------	-------	-------	-------------	--------	-------

**Console Table**

30"(762mm)    20"(508mm)    66"(1676mm)

Center drawer with lock    OTTS-2066    \$1452

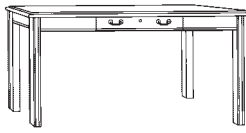

- Wood veneer top with solid wood edge.
- One lock standard.

**To Order, Specify:**

- 1) Product number.
- 2) Wood finish color.

OTTS-2066

**Table Desk**

30"(762mm)    36"(914mm)    66"(1676mm)

Center drawer with lock    OTDT-3666    \$1712

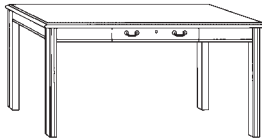

- Wood veneer top with solid wood edge.
- One lock standard.

**To Order, Specify:**

- 1) Product number.
- 2) Wood finish color.

OTDT-3666

# Nottingham

	Height	Depth	Width	Description	Number	Price
<b>Double Pedestal Desk Overhang Top</b>	30"(762mm)	36"(914mm)	72"(1829mm)	Pencil/box/file pedestals	OTDO-3672	<b>\$3116</b>
	30"(762mm)	44"(1118mm)	82"(2083mm)		OTDO-4482	<b>\$3918</b>

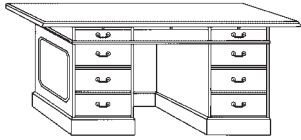

OTDO-3672  
OTDO-4482

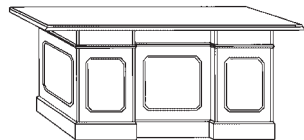

(Approach View)

- Available with wood veneer or plastic laminate top.
- 6"(152mm) overhang on approach and sides (OTDO-3672 desk).
- 8"(203mm) overhang on approach and sides (OTDO-4482 desk).
- Dictation slide in each pedestal (user's side).
- Center drawer.
- One central lock.
- Filing options include: OTDO-3672 — letter size files placed front-to-back, and letter or legal size files placed side-to-side. OTDO-4482 — legal size files placed front-to-back, and letter or legal size files placed side-to-side.
- Kneespace dimensions: 27 3/4"(705mm) wide; 24 1/4"(616mm) high.
- OTDO-3672 top and chassis ship assembled, OTDO-4482 top and chassis shipped unassembled.

**To Order, Specify:**

- 1) Product number.
- 2) Wood finish color.
- 3) Optional plastic laminate top. 47-300 (matches Spencer wood finish).
- 4) Grommet option.

**Factory Installed Grommet Options:**

To specify a left grommet (from the user's side), add **V** to the end of the last functional option specified on the product number and add **\$78** list. Add **Z** to specify a right grommet and add **\$78** list. Add **J** to specify a left and right grommet and add **\$155** list.

<b>Double Pedestal Desk Flush Top</b>	30"(762mm)	30"(762mm)	60"(1524mm)	Pencil/box/file pedestals	OTDD-3060	<b>\$2877</b>
	30"(762mm)	36"(914mm)	66"(1676mm)		OTDD-3666	<b>\$3012</b>



OTDD-3060  
OTDD-3666

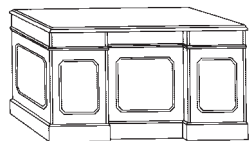

(Approach View)

- Available with wood veneer or plastic laminate top.
- Approach side dictation slide.
- Dictation slide in each pedestal (user's side).
- Center drawer.
- One central lock.
- Filing options include: OTDD-3060 — letter size files placed front-to-back, and letter or legal size files placed side-to-side. OTDD-3666 — legal size files placed front-to-back, and letter or legal size files placed side-to-side.
- Kneespace dimensions: 27 3/4"(705mm) wide; 24 1/2"(622mm) high.

**To Order, Specify:**

- 1) Product number.
- 2) Wood finish color.
- 3) Optional plastic laminate top. 47-300 (matches Spencer wood finish).
- 4) Grommet option.

**Factory Installed Grommet Options:**

To specify a left grommet (from the user's side), add **V** to the end of the last functional option specified on the product number and add **\$78** list. Add **Z** to specify a right grommet and add **\$78** list. Add **J** to specify a left and right grommet and add **\$155** list.

# Nottingham

	Height	Depth	Width	Description	Number	Price
<b>Single Pedestal Desk</b>	30"(762mm)	30"(762mm)	66"(1676mm)	Pencil/box/file pedestal	OTDS-3066-L or -R	<b>\$2523</b>
	30"(762mm)	36"(914mm)	72"(1829mm)		OTDS-3672-L or -R	<b>\$2970</b>

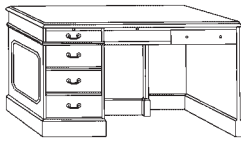

OTDS-3066-L  
(Left-hand shown)

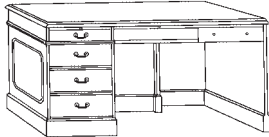

OTDS-3672-L  
(Left-hand shown)

- Available with wood veneer top or plastic laminate top.
- Approach dictation slide standard on OTDS-3672 only.
- Center drawer.
- One central lock.
- Filing options include: OTDS-3066 — letter size files placed front-to-back, and letter or legal size files placed side-to-side. OTDS-3672 — legal size files placed front-to-back, and letter or legal size files placed side-to-side.
- Kneespace dimensions:  
OTDS-3066: 25 3/4"(654mm) wide; 24 1/4"(616mm) high.  
OTDS-3672: 28 3/4"(730mm) wide; 24 1/4"(616mm) high.
- Must be used with returns and bridges.

**To Order, Specify:**

- 1) Product number.  
—Specify left- or right-hand orientation.
- 2) Wood finish color.
- 3) Optional plastic laminate top. 47-300 (matches Spencer wood finish).
- 4) Grommet option.

**Factory Installed Grommet Options:**

To specify a left grommet (from the user's side), add **V** to the end of the last functional option specified on the product number and add **\$78** list.

Add **Z** to specify a right grommet and add **\$78** list.

Add **J** to specify a left and right grommet and add **\$155** list.

# Nottingham

	Height	Depth	Width	Description	Number	Price
<b>Desk-Height Return</b>	30"(762mm)	24"(610mm)	49"(1245mm)	Pencil/box/file pedestal	OTRE-2449-L or -R	\$1691

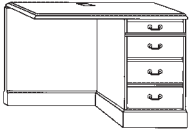

OTRE-2449-R  
(Right-hand shown)

- Available with wood veneer top or plastic laminate top.
- Wireway grommet in top standard.
- Non-locking.
- Attaches to single pedestal desk (66"(1676mm) and 72"(1829mm) only).
- Filing options include: legal size files placed front-to-back, and letter or legal size files placed side-to-side.
- Kneespace dimensions:  
29 3/4"(756mm) wide; 22 1/2"(572mm) deep;  
28 3/4"(730mm) high.

### To Order, Specify:

- 1) Product number.  
–Specify left- or right-hand orientation.
- 2) Wood finish color.
- 3) Optional plastic laminate top. 47-300 (matches Spencer wood finish).

# Nottingham

	Height	Depth	Width	Description	Number	Price
<b>Desk-Height Bridge</b>	30"(762mm)	24"(610mm)	42"(1067mm)		OTBE-2442	\$1036
	30"(762mm)	24"(610mm)	50"(1270mm)		OTBE-2450	1057



OTBE-2442  
OTBE-2450

- Available with wood veneer top or plastic laminate top.
- Attaches to single pedestal desk and rear service unit.
- Wireway grommet in top standard.
- Includes attachment hardware.

**To Order, Specify:**

- 1) Product number.
- 2) Wood finish color.
- 3) Optional plastic laminate top. 47-300 (matches Spencer wood finish).

<b>Desk-Height Bridge</b>	30"(762mm)	24"(610mm)	33"(838mm)		OTBE-2433	\$1005
---------------------------	------------	------------	------------	--	-----------	--------

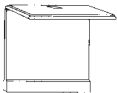

OTBE-2433

- Available with wood veneer top or plastic laminate top.
- Attaches to single pedestal desk and corner unit **only**.
- Wireway grommet in top standard.
- Includes attachment hardware.

**To Order, Specify:**

- 1) Product number.
- 2) Wood finish color.
- 3) Optional plastic laminate top. 47-300 (matches Spencer wood finish).

# Nottingham

	Height	Depth	Width	Description	Number	Price
<b>Single Pedestal Credenza</b>	30"(762mm)	20"(508mm)	72"(1829mm)	File/file pedestal	OTSU-2072-SL or SR	\$2180

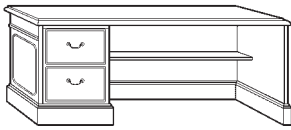

OTSU-2072-SL  
(Left-hand shown)

- Available with wood veneer top or plastic laminate top.
- One kneewell central lock.
- Filing options include: legal size files placed front-to-back, and letter or legal size files side-to-side.
- Shelf is 6"(152mm) deep.
- Kneespace dimensions:  
51 7/16"(1307mm); 18 1/2"(470mm); 27 7/16"(697mm).

### To Order, Specify:

- 1) Product number.  
-Specify left- or right-hand orientation.
- 2) Wood finish color.
- 3) Optional plastic laminate top. 47-300 (matches Spencer wood finish).
- 4) Grommet option.

### Factory Installed Grommet Options:

To specify a left grommet (from the user's side), add **V** to the end of the last functional option specified on the product number and add **\$78** list.  
Add **Z** to specify a right grommet and add **\$78** list.  
Add **Y** to specify a center grommet and add **\$78** list.  
Add **J** to specify a left and right grommet and add **\$155** list.

<b>Double Pedestal Credenza</b>	30"(762mm)	20"(508mm)	72"(1829mm)	File/file pedestals	OTSU-2072-L or -R	\$2294
---------------------------------	------------	------------	-------------	---------------------	-------------------	--------

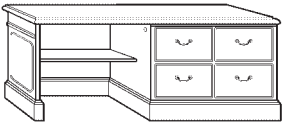

OTSU-2072-R  
(Right-hand shown)

- Available with wood veneer top or plastic laminate top.
- One central lock.
- Storage shelf.
- Filing options include: legal size files placed front-to-back, and letter size files placed side-to-side.
- Shelf is 15"(381mm) deep.
- Kneespace dimensions:  
35 3/16"(894mm) wide; 18 1/2"(470mm) deep;  
28 3/4"(730mm) high.

### To Order, Specify:

- 1) Product number.  
-Specify left- or right-hand orientation.
- 2) Wood finish color.
- 3) Optional plastic laminate top. 47-300 (matches Spencer wood finish).
- 4) Grommet option.

### Factory Installed Grommet Options:

To specify a left grommet (from the user's side), add **V** to the end of the last functional option specified on the product number and add **\$78** list.  
Add **Z** to specify a right grommet and add **\$78** list.  
Add **Y** to specify a center grommet and add **\$78** list.  
Add **J** to specify a left and right grommet and add **\$155** list.

<b>Corner Unit</b>	30"(762mm)	41"(1041mm)	41"(1041mm)		OTCU-4141	\$1712
--------------------	------------	-------------	-------------	--	-----------	--------

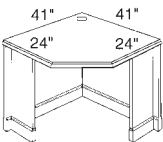

OTCU-4141

- Available with wood veneer top or plastic laminate top.
- Full-height back panels.
- Wireway grommet in top standard.
- Freestanding or used in groupings.

### To Order, Specify:

- 1) Product number.
- 2) Wood finish color.
- 3) Optional plastic laminate top. 47-300 (matches Spencer wood finish).



# Nottingham

	Height	Depth	Width	Description	Number	Price
<b>Executive L-Desk</b>	30"(762mm)	36"(914mm)	72"(1829mm)	Desk	OTLE-3672-L or -R	<b>\$4010</b>
	30"(762mm)	24"(610mm)	49"(1245mm)	Return		

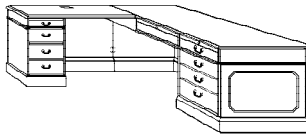

OTLE-3672-L  
(Left-hand shown)

- Available with wood veneer top or plastic laminate top.
- Single pedestal desk (OTDS-3672) with approach dictation slide, center drawer and pencil/box/file pedestal with one lock.
- Desk-height return (OTRE-2449) with box/box/file drawers without lock.
- Wireway grommet in return top standard.
- Filing options include: legal size files placed front-to-back, and letter or legal size files placed side-to-side.
- Kneespace dimensions:  
 Desk: 28 3/4"(730mm) wide;  
 24 1/4"(616mm) high.  
 Return: 29 3/4"(756mm) wide;  
 22 1/2"(572mm) deep;  
 28 3/4"(730mm) high.

**To Order, Specify:**

- 1) Product number.  
 –Specify left- or right-hand orientation.
- 2) Wood finish color.
- 3) Optional plastic laminate top. 47-300 (matches Spencer wood finish).
- 4) Grommet option.

**Factory Installed Grommet Options:**

To specify a left grommet (from the user's side), add **V** to the end of the last functional option specified on the product number and add **\$78** list.  
 Add **Z** to specify a right grommet and add **\$78** list.  
 Add **J** to specify a left and right grommet and add **\$155** list.

- Optional grommets will be in desk.

# Nottingham

	Height	Depth	Width	Description	Number	Price
<b>Executive U-Station Double Pedestal Credenza</b>	30"(762mm)	36"(914mm)	72"(1829mm)	Desk	OTUE-3672-L or -R	<b>\$6163</b>
		24"(610mm)	50"(1270mm)	Bridge		
		20"(508mm)	72"(1829mm)	Double Pedestal Credenza		

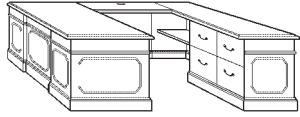

OTUE-3672-R  
(Right-hand shown)

- Available with wood veneer top or plastic laminate top.
- Single pedestal desk (OTDS-3672) with approach dictation slide, center drawer and pencil/box/file pedestal with one lock.
- Desk-height bridge (OTBE-2450) with wireway grommet standard.
- Double pedestal credenza (OTSU-2072) with two file/file pedestals and one central lock.
- Filing options include: legal size files placed front-to-back, and letter or legal size files placed side-to-side.
- Kneespace dimensions:  
Desk: 28 3/4"(730mm) wide;  
24 1/4"(616mm) high.  
Credenza: 11 3/16"(284mm) wide;  
18 1/2"(470mm) deep;  
28 3/4"(730mm) high.

### To Order, Specify:

- 1) Product number.  
–Specify left- or right-hand orientation.
- 2) Wood finish color.
- 3) Optional plastic laminate top. 47-300 (matches Spencer wood finish).
- 4) Factory installed grommet option.

### Factory Installed Grommet Options:

To specify a left grommet (from the user's side), add **V** to the end of the last functional option specified on the product number and add **\$78** list.

Add **Z** to specify a right grommet and add **\$78** list.

Add **Y** to specify a center grommet and add **\$78** list (credenza only).

Add **J** to specify a left and right grommet and add **\$155** list.

Specify desk options first, followed by credenza option.

<b>Executive U-Station Single Pedestal Credenza</b>	30"(762mm)	36"(914mm)	72"(1829mm)	Desk	OTUE-3672-SL or -SR	<b>\$6059</b>
		24"(610mm)	50"(1270mm)	Bridge		
		20"(508mm)	72"(1829mm)	Single Pedestal Credenza		

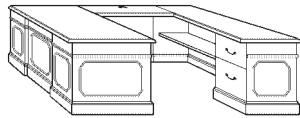

OTUE-3672-SR  
(Right-hand shown)

- Available with wood veneer top or plastic laminate top.
- Single pedestal desk (OTDS-3672) with approach dictation slide, center drawer and pencil/box/file pedestal with one lock.
- Desk-height bridge (OTBE-2450) with wireway grommet standard.
- Single pedestal credenza (OTSU-2072-S) with one file/file pedestal and one central lock.
- Filing options include: legal size files placed front-to-back, and letter or legal size files placed side-to-side.
- Kneespace dimensions:  
Desk: 28 3/4"(730mm) wide;  
24 1/4"(616mm) high.  
Credenza: 30"(762mm) wide;  
18 1/2"(470mm) deep;  
28 3/4"(730mm) high.

### To Order, Specify:

- 1) Product number.  
–Specify left- or right-hand orientation.
- 2) Wood finish color.
- 3) Optional plastic laminate top. 47-300 (matches Spencer wood finish).
- 4) Factory installed grommet option.

### Factory Installed Grommet Options:

To specify a left grommet (from the user's side), add **V** to the end of the last functional option specified on the product number and add **\$78** list.

Add **Z** to specify a right grommet and add **\$78** list.

Add **Y** to specify a center grommet and add **\$78** list (credenza only).

Add **J** to specify a left and right grommet and add **\$155** list.

Specify desk options first, followed by credenza option.

# Nottingham

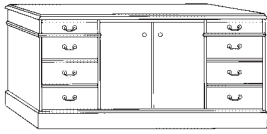
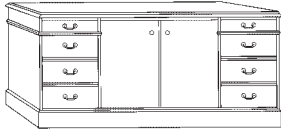
	Height	Depth	Width	Description	Number	Price
 <p>OTC-2066-969</p>  <p>OTC-2072-969</p>	30''(762mm)	20''(508mm)	66''(1676mm)	Pencil/box/file, two-door storage, Pencil/box/file	OTC-2066-969	\$2377
	30''(762mm)	20''(508mm)	72''(1829mm)	Pencil/box/file, two-door storage, Pencil/box/file	OTC-2072-969	2648

- Available with wood veneer top or plastic laminate top.
- Two locks standard on pedestal.
- Center cabinet with adjustable shelf and non-locking hinged doors.
- Filing options include: legal size files placed front-to-back, and letter or legal size files placed side-to-side.

**To Order, Specify:**

- 1) Product number.
- 2) Wood finish color.
- 3) Optional plastic laminate top. 47-300 (matches Spencer wood finish).

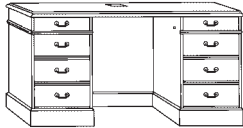
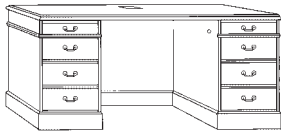



	Height	Depth	Width	Description	Number	Price
 <p>OTCK-2066-9M9</p>  <p>OTCK-2072-9M9</p>	30''(762mm)	20''(508mm)	66''(1676mm)	Pencil/box/file, kneespace, Pencil/box/file	OTCK-2066-9M9	\$2284
	30''(762mm)	20''(508mm)	72''(1829mm)	Pencil/box/file, kneespace, Pencil/box/file	OTCK-2072-9M9	2346

- Available with wood veneer top or plastic laminate top.
- Wireway grommet in top standard.
- Each pedestal standard with lock.
- OTCK-2066-9M9 credenza will not accept standard keyboard tray.
- Filing options include: legal size files placed front-to-back, and letter or legal size files placed side-to-side.
- Kneespace dimensions:  
 OTCK-2066-9M9: 27 3/4''(705mm) wide;  
 28 7/8''(734mm) high.  
 OTCK-2072-9M9: 33 3/4''(857mm) wide;  
 17 3/4''(451mm) high.

**To Order, Specify:**

- 1) Product number.
- 2) Wood finish color.
- 3) Optional plastic laminate top. 47-300 (matches Spencer wood finish).

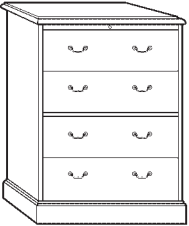
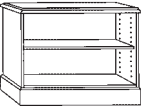
# Nottingham

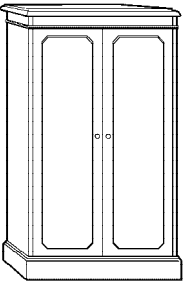
	Height	Depth	Width	Description	Number	Price
<b>Two-High Lateral Files</b>	30"(762mm)	20"(508mm)	38"(965mm)	Two drawers	OTLF-238	<b>\$1441</b>
	30"(762mm)	20"(508mm)	66"(1676mm)	Four drawers	OTLF-266	<b>2377</b>
	<ul style="list-style-type: none"> <li>Available with wood veneer top or plastic laminate top.</li> <li>Letter or legal filing, front-to-back or side-to-side.</li> <li>Standard with one lock and anti-tilt mechanism.</li> </ul>			<b>To Order, Specify:</b> <ol style="list-style-type: none"> <li>Product number.</li> <li>Wood finish color.</li> <li>Optional plastic laminate top. 47-300 (matches Spencer wood finish).</li> </ol>		
OTLF-238						
						
OTLF-266						
<b>Four-High Lateral File</b>	52 13/16"(1341mm)	20"(508mm)	38"(965mm)		OTLF-438	<b>\$3067</b>
	<ul style="list-style-type: none"> <li>Wood veneer top with solid wood edge.</li> <li>Letter or legal filing, front-to-back or side-to-side.</li> <li>Standard with one lock and anti-tilt mechanism.</li> </ul>			<b>To Order, Specify:</b> <ol style="list-style-type: none"> <li>Product number.</li> <li>Wood finish color.</li> </ol>		
OTLF-438						
<b>Two-High Bookcase</b>	30"(762mm)	15 1/2"(394mm)	38"(965mm)	One adjustable shelf	OTBC-3038	<b>\$919</b>
	<ul style="list-style-type: none"> <li>Available with wood veneer top or plastic laminate top.</li> <li>Adjustable shelf at 1 1/4"(32mm) increments.</li> </ul>			<b>To Order, Specify:</b> <ol style="list-style-type: none"> <li>Product number.</li> <li>Wood finish color.</li> <li>Optional plastic laminate top. 47-300 (matches Spencer wood finish).</li> </ol>		
OTBC-3038						
<b>Four-High Bookcase</b>	52"(1321mm)	15 1/2"(394mm)	38"(965mm)	Three adjustable shelves	OTBC-5238	<b>\$1296</b>
	<ul style="list-style-type: none"> <li>Wood top only.</li> <li>Adjustable shelves at 1 1/4"(32mm) increments.</li> </ul>			<b>To Order, Specify:</b> <ol style="list-style-type: none"> <li>Product number.</li> <li>Wood finish color.</li> </ol>		
OTBC-5238						
<b>Wardrobe Unit</b>	76 1/2"(1943mm)	21"(533mm)	38 1/4" (972mm)		OIEW-7638	<b>\$4070</b>
	<ul style="list-style-type: none"> <li>Wood veneer top with solid wood edge.</li> <li>Four adjustable shelves on left side; one coat rod with fixed shelf on right side.</li> <li>Non-locking doors.</li> </ul>			<b>To Order, Specify:</b> <ol style="list-style-type: none"> <li>Product number.</li> <li>Wood finish color.</li> </ol>		
OTW-7638						

# Nottingham

	Height	Depth	Width	Description	Number	Price
<b>Open Vertical Storage Unit</b>	47"(1194mm)	15 1/2"(394mm)	66"(1676mm)		OTCB-4766	\$2599
			72"(1829mm)		OTCB-4772	3006

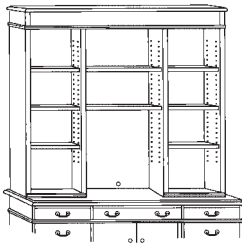

OTCB-4766  
OTCB-4772

- Three adjustable shelves in each end compartment.
- Two adjustable shelves in center section.
- Can be used with OTC-2066-969, OTCK-2066-9M9, OTLF-266, OTSU-2072.
- Adjustable shelves at 1 1/4"(32mm) increments.
- Standard wireway grommet located in center of back panel.
- Attaches to credenza top, same width.

**To Order, Specify:**

- 1) Product number.
- 2) Wood finish color.

<b>Four-Door Vertical Storage Unit</b>	47"(1194mm)	15 1/2"(394mm)	66"(1676mm)	Four doors	OTVS-4766	\$2599
			72"(1829mm)		OTVS-4772	3006

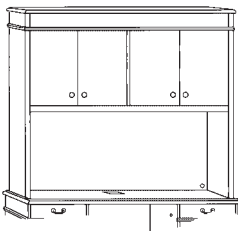

OTVS-4766  
OTVS-4772

- Four hinged, non-locking doors (2 compartments) with adjustable shelf in each compartment.
- Standard wireway grommet located in each corner of back panel.
- Can be used with OTC-2066-969, OTCK-2066-9M9, OTLF-266, OTSU-2072, OTC-2072-969, OTCK-2072-9M9.
- Adjustable shelves at 1 1/4"(32mm) increments.
- Attaches to credenza top, same width.
- Attachment hardware provided.

**To Order, Specify:**

- 1) Product number.
- 2) Wood finish color.

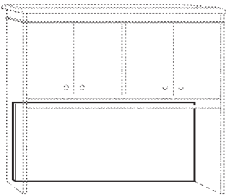
<b>Tackboard</b>	Description	Number	A	B	C
	Attaches to 66"-wide vertical storage unit	OTTB-66D	\$309	\$322	\$345
	Attaches to 72"-wide vertical storage unit	OTTB-72D	320	333	356

OTTB-66D  
OTTB-72D

- Mounts to back panel on four-door vertical storage unit.
- Requires field installation.
- COM yardage:  
66" tackboard — 1.88  
72" tackboard — 2.00

**To Order, Specify:**

- 1) Product number.
- 2) Fabric surface and colorway.

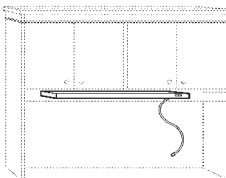
	Attaches to 66"-wide vertical storage unit	YTL-60	\$280
	Attaches to 72"-wide vertical storage unit	YTL-70	369
	Attaches to 66" vertical storage unit — Chicago	YTL-60-C	\$343
	Attaches to 72" vertical storage unit — Chicago	YTL-70-C	432

YTL-60  
YTL-70

- Mounts to the underside of a four-door vertical storage unit.
- Prices includes six-foot power cord, one T-8 fluorescent lamp, and mounting screws.
- Requires field installation.
- Standard in black finish color.

**To Order, Specify:**

- 1) Product number.  
(No finish specification required.)

<b>Presentation Board</b>	48"(1219mm)	4"(102mm)	48"(1219mm)	OTPB-4848	\$3233
---------------------------	-------------	-----------	-------------	-----------	--------

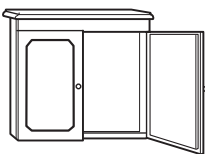

OTPB-4848

- Double-hinged doors with fabric covered tackboards equipped with flipchart pins.
- Retractable projection screen.
- Magnetic, porcelain writing surface.
- Accessories include four dry-markers and an eraser.

**To Order, Specify:**

- 1) Product number.
- 2) Wood finish color.
- 3) Fabric surface and color.

# Nottingham

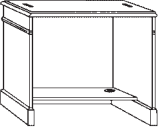
	Height	Depth	Width	Description	Number	Price
<b>VDT Table</b>	30"(762mm)	24"(610mm)	36 1/2"(927mm)		OTCS-2437	\$1223
	<ul style="list-style-type: none"> <li>Available with wood veneer top or plastic laminate top.</li> <li>Lower paper shelf and continuous rear access opening.</li> <li>Wireway grommets in top standard.</li> <li>Kneespace dimensions: 33 3/4"(857mm) wide; 21 7/8"(556mm) deep; 28 3/4"(730mm) high.</li> </ul>			<b>To Order, Specify:</b> 1) Product number. 2) Wood finish color. 3) Optional plastic laminate top. 47-300 (matches Spencer wood finish).		
OTCS-2437 Class SA						

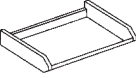
<b>Keyboard Pull-out Tray</b>	2 1/2"(64mm)	11 1/4"(286mm)	24"(610mm)		OT-KT	\$278
	<ul style="list-style-type: none"> <li>Complete with mounting hardware.</li> <li>Suspension locks in both closed and extended positions.</li> <li>Requires field installation.</li> </ul>			<b>To Order, Specify:</b> 1) Product number. 2) Wood finish color.		
OT-KT Class SA						

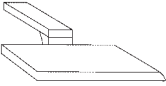
<b>Articulating Keyboard Tray</b>	Adjustable	14"(356mm)	23"(584mm)		Y-AKT	\$284
	<ul style="list-style-type: none"> <li>Adjustable black PVC tray.</li> <li>Offers height adjustment, tray tilt adjustment, and front-to-back movement.</li> <li>Complete with mounting hardware.</li> <li>Requires field installation.</li> </ul>			<b>To Order, Specify:</b> 1) Product number. (No finish specification required.)		
Y-AKT Class SA						

<b>Wireway Grommet and Caps (Field Installed)</b>		1 1/2"(38mm)	2 7/8"(73mm)	Field installed	Y-G	\$50
	<ul style="list-style-type: none"> <li>Two-piece metal cap.</li> <li>Black finish color.</li> </ul>			<b>To Order, Specify:</b> 1) Product number. (No finish specification required.)		
Y-G Class SA						

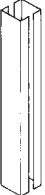
Wire Channel	Description	Number	Price
	Horizontal	M-WC24-H	\$32
	Vertical	M-WC24-V	46
M-WC24-H Class QA	<ul style="list-style-type: none"> <li>Secures to the inside kneewell of casegoods.</li> <li>Requires field installation.</li> </ul>		
	<b>To Order, Specify:</b> 1) Product number. (No finish specification required.)		
M-WC24-V Class QA			

<b>Extra Keys for Factory Installed Locks</b>	Additional key	Y-KY	\$12
	<ul style="list-style-type: none"> <li>Key numbering KY-100 - KY-119</li> </ul>	<b>To Order, Specify:</b> 1) Product number. 2) Key number. (Example: Y-KY, KY-100)	
Class SA			

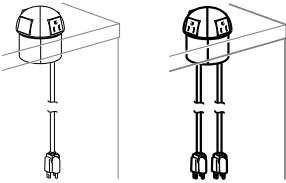
<b>Power Domes</b>	Two (2) power outlets and two (2) plates for data connections	OLTD-2	\$144
	Four (4) power outlets	OLTD-4	158
	<ul style="list-style-type: none"> <li>Provides power and communication access at desk top height.</li> <li>Mounts into a field-cut 3"(76mm) diameter hole.</li> <li>Standard in black finish color only.</li> <li>OLTD-2 accepts category 3 connection hardware.</li> <li>OLTD-2 includes one (1) 72"(1829mm) long power cord and 15-amp plug. OLTD-4 includes two (2) 72"(1829mm) long power cords and 15-amp plugs.</li> <li>Requires field installation.</li> </ul>		
OLTD-2 Class RA	<b>To Order, Specify:</b> 1) Product number. (No finish specification required.)		
OLTD-4			

# Entropy Tables by SMED

## Construction Features

Entropy table tops are constructed of a 1 1/2"(38mm)-thick, MDF core with Glacier™ edges faced with wood veneer on tops.

Entropy table base is constructed 2 3/16"(56mm)-thick, medium-density particle board core with 1/8"(3mm) solid wood vertical edges and is faced with wood veneer. Base top edge is faced with etched metal or wood veneer.

Conference end top is provided with a half support leg, field-mounted to the underside of the top. The half support leg is constructed of a 1 1/4"(30mm)-thick, medium-density particle board core with a 1/8"(3mm) solid wood vertical edge and is faced with wood veneer.

Tops and bases are jointed together with alignment dowels and secured with concentric-bolt connectors. A special allen wrench is provided with each Entropy product order.

Two adjustable floor glides with a 1 1/2"(38mm) range are standard on each base. One additional glide is supplied on each half support leg.

Grain pattern and wood characteristics will be similar for each specific order tag. Future orders that add-on to original orders will not exactly match pattern and grain characteristics. Note: Oxidation of wood products can affect the color of wood over time. As a result, new add-on orders may not match the color of older product.

## Wood/Finish Features

Entropy features all standard wood by SMED colors and veneers. A complete listing of finishes for Entropy table tops and base can be found on pages 207-209.

Entropy veneers are quarter-sliced.

Entropy table tops and base are finished with a two step finishing process and sealed with conversion varnish.

## Edge Details Glacier (only)

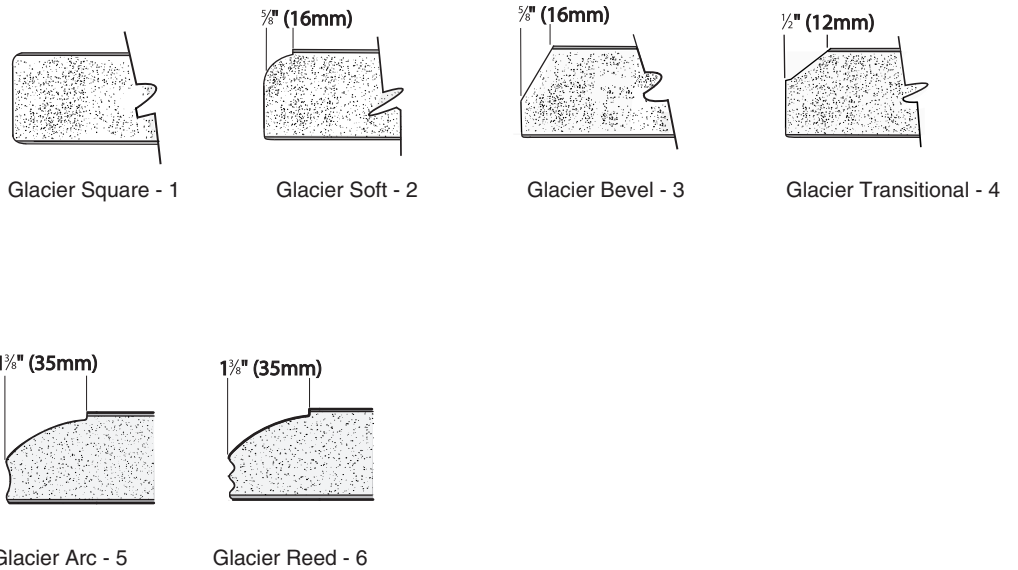

# Entropy Tables by SMED

## Common Configurations

The following plan view examples illustrate possible combinations of individual top shapes and bases. A product list for each combination may be used for ordering purposes, or construct your own table configuration using the individual tops and base found on pages 169 and 170.



(Example 1)

- (1) CEN2-3060- ■
- (2) CENE-3015- ■
- (3) CENS-18- ■

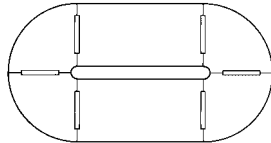

(Example 2)

- (2) CEN2-3060- ■
- (4) CENC-3333- ■
- (6) CENS-18- ■

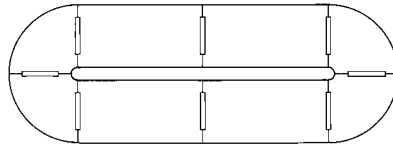

(Example 3)

- (4) CEN2-3060- ■
- (4) CENC-3333- ■
- (8) CENS-18- ■

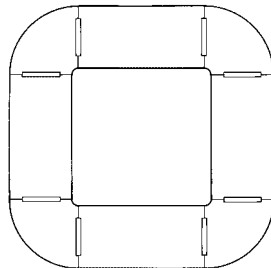

(Example 4)

- (4) CEN2-3060- ■
- (4) CENC-3333- ■
- (8) CENS-18- ■

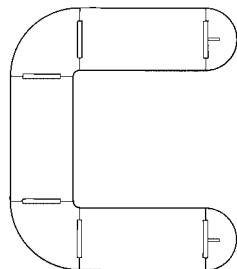

(Example 5)

- (3) CEN2-3060- ■
- (2) CENC-3333- ■
- (2) CENE-3015- ■
- (6) CENS-18- ■



# Entropy Tables by SMED

Wood Top with Glacier Edge

	Height	Depth	Width	Number	Wood Finish Group			
					1	2	3	4

**Corner Top**

1 1/2" (38mm)	33" (838mm)	33" (838mm)	CENC-3333-	\$1278	\$1345	\$1412	\$1614
---------------	-------------	-------------	------------	--------	--------	--------	--------

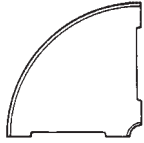

CENC-3333

- Wood veneer top with glacier edges.

**To Order, Specify:**

- 1) Product number.  
–Specify edge detail as **9th digit** in product number.
  - 1** Glacier Square
  - 2** Glacier Soft
  - 3** Glacier Bevel
  - 4** Glacier Transitional
  - 5** Glacier Arc
  - 6** Glacier Reed
- 2) Wood finish color.

**2-Way Top**

1 1/2" (38mm)	30" (762mm)	30" (762mm)	CEN2-3030-	\$1081	\$1138	\$1195	\$1366
---------------	-------------	-------------	------------	--------	--------	--------	--------

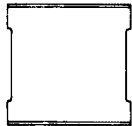

CEN2-3030

- Wood veneer top with glacier edges.

**To Order, Specify:**

- 1) Product number.  
–Specify edge detail as **9th digit** in product number.
  - 1** Glacier Square
  - 2** Glacier Soft
  - 3** Glacier Bevel
  - 4** Glacier Transitional
  - 5** Glacier Arc
  - 6** Glacier Reed
- 2) Wood finish color.

**2-Way Top**

1 1/2" (38mm)	30" (762mm)	60" (1524mm)	CEN2-3060-	\$1144	\$1204	\$1264	\$1445
---------------	-------------	--------------	------------	--------	--------	--------	--------



CEN2-3060

- Wood veneer top with glacier edges.

**To Order, Specify:**

- 1) Product number.  
–Specify edge detail as **9th digit** in product number.
  - 1** Glacier Square
  - 2** Glacier Soft
  - 3** Glacier Bevel
  - 4** Glacier Transitional
  - 5** Glacier Arc
  - 6** Glacier Reed
- 2) Wood finish color.

**Tag for ordering**

Note: Entropy is manufactured such that every piece in an office can be constructed from the same wood flitch. This provides superior color and grain matching. In order to meet these high standards, Haworth requires that all items in the order be tagged with an individual office location. Items will be manufactured, labeled and shipped such that installers can easily identify items by office.

# Entropy Tables by SMED

Wood Top with Glacier Edge / Base

	Height	Depth	Width	Number	Wood Finish Group			
					1	2	3	4
<b>End Top</b>	1 1/2"(38mm)	15"(381mm)	30"(762mm)	CENE-3015- <span style="background-color: #cccccc; padding: 0 2px;"> </span>	\$1187	\$1249	\$1311	\$1499

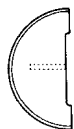

CENE-3015

- Includes half support leg.
- Wood veneer top with glacier edges.

**To Order, Specify:**

- 1) Product number.  
 -Specify edge detail as **9th digit** in product number.
 

1	Glacier Square
2	Glacier Soft
3	Glacier Bevel
4	Glacier Transitional
5	Glacier Arc
6	Glacier Reed
- 2) Wood finish color.

**Base**



CENS-18

<b>Wood</b>								
29 3/8"(745mm)	2 3/8"(62mm)	18"(457mm)	CENS-18	\$508	\$535	\$562	\$642	
<b>Metal Inlay</b>								
29 3/8"(745mm)	2 3/8"(62mm)	18"(457mm)	CENS-18	\$587	\$614	\$641	\$721	

- Wood base with etched metal top plate or wood veneer top surface.
- Base extends flush with top for exposed etched metal or wood veneer accent.
- One base required between two tops.
- Adjustable with a 1 1/2"(38mm) range.

**To Order, Specify:**

- 1) Product number.
- 2) Wood finish color.
- 3) Etched metal finish color (if specified).

**Tag for ordering**

Note: Entropy is manufactured such that every piece in an office can be constructed from the same wood flitch. This provides superior color and grain matching. In order to meet these high standards, Haworth requires that all items in the order be tagged with an individual office location. Items will be manufactured, labeled and shipped such that installers can easily identify items by office.

# Series K/Profile/Tripoli Tables by SMED

**Construction Features**

Series K, Profile and Tripoli one piece tops are constructed with 1 1/4"(30mm) MDF substrate and solid wood edges.

Series K, Profile and Tripoli multiple piece tops are constructed with 1 1/4"(30mm) MDF substrate with solid wood edges and tight joint fasteners.

Solid wood edges are 1 3/8"(35mm) x 2 3/4"(70mm) thick for Series K tops, 3/4"(19mm) x 1 3/4" (44mm) thick for Profile and 3/4"(19mm) x 1 1/4" (30mm) thick for Tripoli.

Solid wood edges are constructed of the same species as the veneer featured on the tops. Anegre veneer is matched with Agathis solids.

Glacier edges are not available on Series K, Profile and Tripoli tables.

**Wood/Finish Features**

Series K, Profile, and Tripoli feature all standard wood by SMED colors and veneers.

All exposed veneers are plain-sliced and book- and center-matched.

Wood grain is crosswise on all tables.

A complete listing of finishes for conference tables can be found on pages 207-209.

**Round Premium Wood Inlay Options**

Only round conference table tops may be specified with a diamond, reverse-diamond, or sunburst veneer inlay.

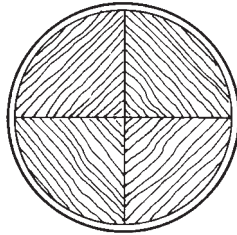

Option V "Diamond"

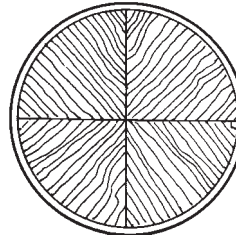

Option R "Reverse Diamond"

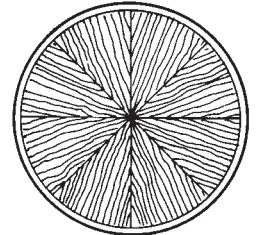

Option B "Sunburst"

**Metal Inlay Tops**

Series K and Profile tops are available with etched metal tops. These metal tops make each table unique and are extremely durable. They are recommended for severe use applications.

**Edge Detail Series K**

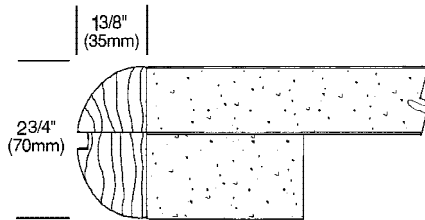

**Edge Details Profile Series**

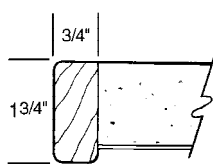

"Square Edge" -E

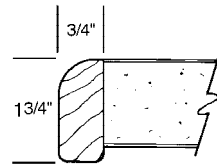

"Soft Edge" -F

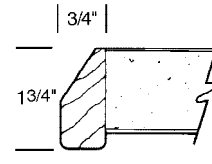

"Bevel Edge" -G

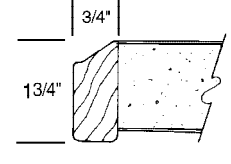

"Transitional Edge" -H

**Edge Details Tripoli Series**

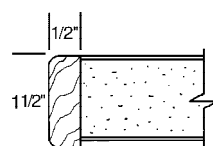

"Square Edge" -1

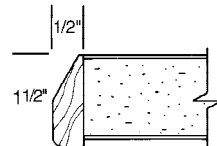

"Bevel Edge" -2

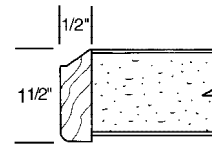

"Chamfer Edge" -3

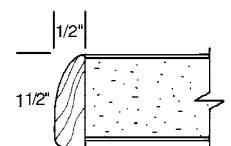

"Radius Edge" -4

# Series K Table Tops by SMED

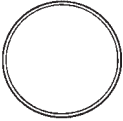
	Size	No. of Pieces	Seating Capacity	Power Cut-Out Option	Number	Wood Finish Group				
						1	2	3	4	
 Round Top	<b>Wood Top</b>									
	53"(1346mm)	1	6	N/A	CSKR-53	\$5440	\$5726	\$6012	\$6871	
	60"(1524mm)	1	7	N/A	CSKR-60	6529	6873	7217	8248	
	<b>Metal Inlay Top</b>									
	53"(1346mm)	1	6	N/A	CSKR-53	\$6127	\$6413	\$6699	\$7558	
	60"(1524mm)	1	7	N/A	CSKR-60	7354	7638	8042	9073	

CSKR

- Wood veneer top or etched metal inlay.
- Solid wood edge (1 3/8" x 2 3/4" (35mm x 70mm) thick).
- Bases ordered separately, see pages 179, 181 and 182.
- Special inlay if wood top specified.

**To Order, Specify:**

- 1) Product number.
- 2) Special inlay (if wood specified).  
V = Diamond, add \$1300 list.  
R = Reverse Diamond, add \$1300 list.  
B = Sunburst, add \$1550 list.
- 3) Wood finish color.
- 4) Etched metal inlay finish color (if specified).

## Racetrack Top



CSKT

<b>Wood Top</b>										
53" x 96"(1346mm x 2438mm)	2	6 to 8	S	CSKT-5396	\$ 8996	\$ 9470	\$ 9944	\$11364		
60" x 120"(1524mm x 3048mm)	3	6 to 8	S	CSKT-6012	9971	10496	11021	12595		
53" x 143"(1346mm x 3632mm)	3	8 to 10	D	CSKT-5343	10271	10812	11353	12974		
60" x 143"(1524mm x 3632mm)	3	8 to 10	D	CSKT-6043	11525	12132	12739	14558		
53" x 167"(1346mm x 4242mm)	4	10 to 12	D	CSKT-5367	11673	12287	12901	14744		
60" x 167"(1524mm x 4242mm)	4	10 to 12	D	CSKT-6067	12319	12967	13615	15560		
53" x 191"(1346mm x 4851mm)	4	12 to 14	D	CSKT-5391	12420	13074	13728	15689		
60" x 214"(1524mm x 5436mm)	5	12 to 14	D	CSKT-6014	13927	14660	15393	17592		
60" x 238"(1524mm x 6045mm)	5	14 to 16	D	CSKT-6038	15664	16488	17312	19786		
<b>Metal Inlay Top</b>										
53" x 96"(1346mm x 2438mm)	2	6 to 8	S	CSKT-5396	\$10132	\$10606	\$11080	\$12500		
60" x 120"(1524mm x 3048mm)	3	6 to 8	S	CSKT-6012	11231	11756	12281	13855		
53" x 143"(1346mm x 3632mm)	3	8 to 10	D	CSKT-5343	11568	12109	12650	14271		
60" x 143"(1524mm x 3632mm)	3	8 to 10	D	CSKT-6043	12981	13588	14195	16014		
53" x 167"(1346mm x 4242mm)	4	10 to 12	D	CSKT-5367	13147	13761	14375	16218		
60" x 167"(1524mm x 4242mm)	4	10 to 12	D	CSKT-6067	13875	14523	15171	17116		
53" x 191"(1346mm x 4851mm)	4	12 to 14	D	CSKT-5391	13989	14643	15297	17258		
60" x 214"(1524mm x 5436mm)	5	12 to 14	D	CSKT-6014	15686	16419	17152	19351		
60" x 238"(1524mm x 6045mm)	5	14 to 16	D	CSKT-6038	17643	18467	19291	21765		

- Wood veneer top or etched metal inlay.
- Solid wood edge (1 3/8" x 2 3/4" (35mm x 70mm) thick).
- Bases ordered separately, see pages 179-183.

**To Order, Specify:**

- 1) Product number.
- 2) Wood finish color.
- 3) Etched metal inlay finish color (if specified).

**Power Hatch Cut-Out Option:**

Specification of Power Hatch Cut-Out requires modification of product number and price. Cut-out(s) will be centered between bases.

One cut-out, add **-S** to end of product number and add \$100 list.  
Two cut-outs, add **-D** to end of product number and add \$200 list.  
**Example:** CSKT-5396-S.



**NOTE:**  
Order separately specified power hatches and cable management from pages 194-195.

## Series K Table Tops by SMED

Size	No. of Pieces	Seating Capacity	Power Cut-Out Option	Number	Wood Finish Group				
					1	2	3	4	
<b>Rectangle Top</b>					<b>Wood Top</b>				
	53" x 97"(1346mm x 2464mm)	2	8	S	CSKC-5397	\$ 6864	\$ 7688	\$ 8512	\$10986
	53" x 121"(1346mm x 3073mm)	3	10	S	CSKC-5321	8426	8869	9312	10643
	60" x 121"(1524mm x 3073mm)	3	10	S	CSKC-6021	8710	9168	9626	11002
	53" x 144"(1346mm x 3658mm)	3	12	D	CSKC-5344	9491	9991	10491	11989
	60" x 144"(1524mm x 3658mm)	3	12	D	CSKC-6044	10121	10654	11187	12785
	60" x 168"(1524mm x 4267mm)	4	12	D	CSKC-6068	10863	11435	12007	13722
	60" x 192"(1524mm x 4877mm)	4	14	D	CSKC-6092	12481	13138	13795	15766
	60" x 215"(1524mm x 5461mm)	5	16	D	CSKC-6015	13962	14697	15432	17636
	60" x 239"(1524mm x 6071mm)	5	18	D	CSKC-6039	15442	16255	17068	19506
	<b>Metal Inlay Top</b>								
53" x 97"(1346mm x 2464mm)	2	8	S	CSKC-5397	\$ 7787	\$ 8611	\$ 9435	\$11909	
53" x 121"(1346mm x 3073mm)	3	10	S	CSKC-5321	9490	9933	10376	11707	
60" x 121"(1524mm x 3073mm)	3	10	S	CSKC-6021	9810	10268	10726	12102	
53" x 144"(1346mm x 3658mm)	3	12	D	CSKC-5344	10690	11190	11690	13188	
60" x 144"(1524mm x 3658mm)	3	12	D	CSKC-6044	11399	11932	12465	14063	
60" x 168"(1524mm x 4267mm)	4	12	D	CSKC-6068	12235	12807	13379	15094	
60" x 192"(1524mm x 4877mm)	4	14	D	CSKC-6092	14058	14715	15372	17343	
60" x 215"(1524mm x 5461mm)	5	16	D	CSKC-6015	15726	16461	17196	19400	
60" x 239"(1524mm x 6071mm)	5	18	D	CSKC-6039	17393	18206	19019	21457	

CSKC

- Wood veneer top or etched metal inlay.
- Solid wood edge (1 3/8" x 2 3/4"(35mm x 70mm) thick).
- Bases ordered separately, see pages 179-183.

**To Order, Specify:**

- 1) Product number.
- 2) Wood finish color.
- 3) Etched metal inlay finish color (if specified).

**Power Hatch Cut-Out Option:**

Specification of Power Hatch Cut-Out requires modification of product number and price. Cut-out(s) will be centered between bases.

One cut-out, add **-S** to end of product number and add **\$100** list.  
 Two cut-outs, add **-D** to end of product number and add **\$200** list.  
**Example:** CSKC-5397-S.

**NOTE:**

Order separately specified power hatches and cable management from pages 194-195.

# Profile Series Table Tops by SMED

Size	No. of Pieces	Seating Capacity	Power Cut-Out Option	Number	Wood Finish Group				
					1	2	3	4	
<b>Round Top</b>									
<b>Wood Top</b>									
42"(1067mm)	1	4	N/A	CPRR-42-	█	\$2332	\$2455	\$2578	\$2946
48"(1219mm)	1	5	N/A	CPRR-48-	█	2464	2594	2724	3113
60"(1524mm)	1	7	N/A	CPRR-60-	█	2643	2782	2921	3338
<b>Metal Inlay Top</b>									
42"(1067mm)	1	4	N/A	CPRR-42-	█	\$2627	\$2750	\$2873	\$3241
48"(1219mm)	1	5	N/A	CPRR-48-	█	2775	2905	3035	3424
60"(1524mm)	1	7	N/A	CPRR-60-	█	2977	3116	3255	3672



- Wood veneer top or etched metal inlay.
- Solid wood edge (3/4" x 1 3/4"(19mm x 44mm) thick).
- Bases ordered separately, see pages 179, 181 and 182.
- Special inlay if wood top specified.

**To Order, Specify:**

- 1) Product number.  
–Specify edge detail as **7th digit** in product number.
  - E** Square edge
  - F** Soft edge
  - G** Bevel edge
  - H** Transitional edge
- 2) Special inlay (if wood specified).  
V = Diamond, add **\$1300** list.  
R = Reverse Diamond, add **\$1300** list.  
B = Sunburst, add **\$1550** list.
- 3) Wood finish color.
- 4) Etched metal inlay finish color (if specified).

<b>Square Top</b>									
<b>Wood Top</b>									
36" x 36"(914mm x 914mm)	1	4	N/A	CPRQ-3636-	█	\$1665	\$1753	\$1841	\$2104
42" x 42"(1067mm x 1067mm)	1	4	N/A	CPRQ-4242-	█	1713	1803	1893	2164
48" x 48"(1219mm x 1219mm)	1	4	N/A	CPRQ-4848-	█	1760	1853	1946	2224
54" x 54"(1372mm x 1372mm)	1	6	N/A	CPRQ-5454-	█	1824	1920	2016	2304
60" x 60"(1524mm x 1524mm)	1	8	N/A	CPRQ-6060-	█	1888	1987	2086	2384
<b>Metal Inlay Top</b>									
36" x 36"(914mm x 914mm)	1	4	N/A	CPRQ-3636-	█	\$1875	\$1963	\$2051	\$2314
42" x 42"(1067mm x 1067mm)	1	4	N/A	CPRQ-4242-	█	1929	2019	2109	2380
48" x 48"(1219mm x 1219mm)	1	4	N/A	CPRQ-4848-	█	1982	2075	2168	2446
54" x 54"(1372mm x 1372mm)	1	6	N/A	CPRQ-5454-	█	2054	2150	2246	2534
60" x 60"(1524mm x 1524mm)	1	8	N/A	CPRQ-6060-	█	2126	2225	2324	2622



- Wood veneer top or etched metal inlay.
- Solid wood edge (3/4" x 1 3/4"(19mm x 44mm) thick).
- Bases ordered separately, see pages 179, 181 and 182.

**To Order, Specify:**

- 1) Product number.  
–Specify edge detail as **9th digit** in product number.
  - E** Square edge
  - F** Soft edge
  - G** Bevel edge
  - H** Transitional edge
- 2) Wood finish color.
- 3) Etched metal inlay finish color (if specified).

# Profile Series Table Tops by SMED

Size	No. of Pieces	Seating Capacity	Power Cut-Out Option	Number	Wood Finish Group			
					1	2	3	4
<b>Racetrack Top</b>								
<b>Wood Top</b>								
48" x 96"(1219mm x 2438mm)	2	8	S	CPRT-4896-	\$4073	\$4287	\$4501	\$5144
48" x 117"(1219mm x 2972mm)	2	10	S	CPRT-4817-	4404	4636	4868	5563
48" x 146"(1219mm x 3708mm)	2	12	D	CPRT-4846-	7039	7410	7781	8892
<b>Metal Inlay Top</b>								
48" x 96"(1219mm x 2438mm)	2	8	S	CPRT-4896-	\$4587	\$4801	\$5015	\$5658
48" x 117"(1219mm x 2972mm)	2	10	S	CPRT-4817-	5143	5192	5424	6119
48" x 146"(1219mm x 3708mm)	2	12	D	CPRT-4846-	7928	8299	8670	9781



CPRT

- Wood veneer top or etched metal inlay.
- Solid wood edge (3/4" x 1 3/4"(19mm x 44mm) thick).
- Bases ordered separately, see pages 179, 180, 182 and 183.

**To Order, Specify:**

- 1) Product number.  
 -Specify edge detail as **9th digit** in product number.
  - E** Square edge
  - F** Soft edge
  - G** Bevel edge
  - H** Transitional edge
- 2) Wood finish color.
- 3) Etched metal inlay finish color (if specified).

**Power Hatch Cut-Out Option:**

Specification of Power Hatch Cut-Out requires modification of product number and price. Cut-out(s) will be centered between bases.

One cut-out, add **-S** to end of product number and add **\$100** list.  
 Two cut-outs, add **-D** to end of product number and add **\$200** list.  
**Example:** CPRT-4896-ES.



**NOTE:**  
 Order separately specified power hatches and cable management from pages 194-195.

# Profile Series Table Tops by SMED

Size	No. of Pieces	Seating Capacity	Power Cut-Out Option	Number	Wood Finish Group			
					1	2	3	4
<b>Boat-Shaped Top</b>								
<b>Wood Top</b>								
48" x 96"(1219mm x 2438mm)	2	8	S	CPRB-4896-	\$3879	\$4083	\$4287	\$4900
48" x 117"(1219mm x 2972mm)	2	10	S	CPRB-4817-	4195	4416	4637	5299
48" x 146"(1219mm x 3708mm)	2	12	D	CPRB-4846-	5439	5725	6011	6870
<b>Metal Inlay Top</b>								
48" x 96"(1219mm x 2438mm)	2	8	S	CPRB-4896-	\$4369	\$4573	\$4777	\$5390
48" x 117"(1219mm x 2972mm)	2	10	S	CPRB-4817-	4725	4946	5167	5829
48" x 146"(1219mm x 3708mm)	2	12	D	CPRB-4846-	6126	6412	6698	7557



CPRB

- Wood veneer top or etched metal inlay.
- Solid wood edge (3/4" x 1 3/4"(19mm x 44mm) thick).
- Bases ordered separately, see pages 179, 180, 182 and 183.

**To Order, Specify:**

- 1) Product number.  
–Specify edge detail as **9th digit** in product number.
  - E** Square edge
  - F** Soft edge
  - G** Bevel edge
  - H** Transitional edge
- 2) Wood finish color.
- 3) Etched metal inlay finish color (if specified).

Size	No. of Pieces	Seating Capacity	Power Cut-Out Option	Number	Wood Finish Group			
					1	2	3	4
<b>Rectangle Top</b>								
<b>Wood Top</b>								
48" x 96"(1219mm x 2438mm)	2	8	S	CPRC-4896-	\$3843	\$4045	\$4247	\$4854
48" x 117"(1219mm x 2972mm)	2	10	S	CPRC-4817-	4155	4374	4593	5249
48" x 146"(1219mm x 3708mm)	2	12	D	CPRC-4846-	6167	6492	6817	7790
<b>Metal Inlay Top</b>								
48" x 96"(1219mm x 2438mm)	2	8	S	CPRC-4896-	\$4328	\$4530	\$4732	\$5339
48" x 117"(1219mm x 2972mm)	2	10	S	CPRC-4817-	4680	4899	5118	5774
48" x 146"(1219mm x 3708mm)	2	12	D	CPRC-4846-	6946	7271	7596	8569



CPRC

- Wood veneer top or etched metal inlay.
- Solid wood edge (3/4" x 1 3/4"(19mm x 44mm) thick).
- Bases ordered separately, see pages 179, 180, 182 and 183.
- Corners feature a 3"(76mm) radius.

**To Order, Specify:**

- 1) Product number.  
–Specify edge detail as **9th digit** in product number.
  - E** Square edge
  - F** Soft edge
  - G** Bevel edge
  - H** Transitional edge
- 2) Wood finish color.
- 3) Etched metal inlay finish color (if specified).

**Power Hatch Cut-Out Option:**

Specification of Power Hatch Cut-Out requires modification of product number and price. Cut-out(s) will be centered between bases.

One cut-out, add **-S** to end of product number and add **\$100** list.  
Two cut-outs, add **-D** to end of product number and add **\$200** list.

**Example:** CPRC-4896-ES.



**NOTE:**  
Order separately specified power hatches and cable management from pages 194-195.



# Tripoli Series Table Tops by SMED

	Size	No. of Pieces	Seating Capacity	Power Cut-Out Option	Number	Wood Finish Group/ Laminate Top			
						1	2	3	4
 CTRR	36"(914mm)	1	3	N/A	CTRR-36-	\$1369	\$1441	\$1513	\$1729
	42"(1067mm)	1	4	N/A	CTRR-42-	1503	1582	1661	1898
	48"(1219mm)	1	5	N/A	CTRR-48-	1624	1710	1796	2052
	54"(1372mm)	1	6	N/A	CTRR-54-	1708	1798	1888	2158
	60"(1524mm)	1	7	N/A	CTRR-60-	2079	2188	2297	2626

- Wood veneer or plastic laminate top.
- Solid wood edge.
- Bases ordered separately, see pages 179, 181, 182 and 184.
- Special inlay if wood top specified.

**To Order, Specify:**

- 1) Product number.  
–Specify edge detail as **7th digit** in product number.
  - 1 Square edge
  - 2 Bevel edge
  - 3 Chamfer edge
  - 4 Radius edge
- 2) Special inlay (if wood specified).  
V = Diamond, add \$1300 list.  
R = Reverse Diamond, add \$1300 list.  
B = Sunburst, add \$1550 list.
- 3) Wood finish color.
- 4) Plastic laminate finish color (if specified).

 CTRQ	36" x 36"(914mm x 914mm)	1	4	N/A	CTRQ-3636-	\$ 956	\$1006	\$1056	\$1207
	42" x 42"(1067mm x 1067mm)	1	4	N/A	CTRQ-4242-	1040	1095	1150	1314
	48" x 48"(1219mm x 1219mm)	1	4	N/A	CTRQ-4848-	1141	1201	1261	1441
	54" x 54"(1372mm x 1372mm)	1	6	N/A	CTRQ-5454-	1256	1322	1388	1586
	60" x 60"(1524mm x 1524mm)	1	8	N/A	CTRQ-6060-	1398	1472	1546	1766

- Wood veneer or plastic laminate top.
- Solid wood edge.
- Bases ordered separately, see pages 179, 181, 182 and 184.

**To Order, Specify:**

- 1) Product number.  
–Specify edge detail as **9th digit** in product number.
  - 1 Square edge
  - 2 Bevel edge
  - 3 Chamfer edge
  - 4 Radius edge
- 2) Wood finish color.
- 3) Plastic laminate finish color (if specified).

 CTRT	42" x 84"(1067mm x 2134mm)	1	6	S	CTRT-4284-	\$2201	\$2317	\$2433	\$2780
	48" x 96"(1219mm x 2438mm)	2	8	S	CTRT-4896-	2916	3069	3222	3683
	48" x 117"(1219mm x 2972mm)	2	10	S	CTRT-4817-	3369	3546	3723	4255
	48" x 146"(1219mm x 3708mm)	2	12	D	CTRT-4846-	4348	4577	4806	5492
	48" x 168"(1219mm x 4267mm)	2	14	D	CTRT-4868-	4793	5045	5297	6054

- Wood veneer or plastic laminate top.
- Solid wood edge.
- Bases ordered separately, see pages 179, 180, 182 and 183.

**To Order, Specify:**

- 1) Product number.  
–Specify edge detail as **9th digit** in product number.
  - 1 Square edge
  - 2 Bevel edge
  - 3 Chamfer edge
  - 4 Radius edge
- 2) Wood finish color.
- 3) Plastic laminate finish color (if specified).

**Power Hatch Cut-Out Option:**

Specification of Power Hatch Cut-Out requires modification of product number and price. Cut-out(s) will be centered between bases.  
 One cut-out, add **-S** to end of product number and add \$100 list.  
 Two cut-outs, add **-D** to end of product number and add \$200 list.  
**Example:** CTRT-4284-1S.



**NOTE:**  
 Order separately specified power hatches and cable management from pages 194-195.

# Tripoli Series Table Tops by SMED

	Size	No. of Pieces	Seating Capacity	Power Cut-Out Option	Number	Wood Finish Group/ Laminate Top			
						1	2	3	4
<b>Boat-Shaped Top</b>	42" x 84"(1067mm x 2134mm)	1	4	S	CTRB-4284-	\$2101	\$2212	\$2323	\$2654
	48" x 96"(1219mm x 2438mm)	2	8	S	CTRB-4896-	2746	2891	3036	3469
	48" x 117"(1219mm x 2972mm)	2	10	S	CTRB-4817-	3327	3502	3672	4202
	48" x 146"(1219mm x 3708mm)	2	12	D	CTRB-4846-	4275	4500	4725	5400
	48" x 168"(1219mm x 4267mm)	2	14	D	CTRB-4868-	4709	4957	5205	5948



CTRB

- Wood veneer or plastic laminate top.
- Solid wood edge.
- Bases ordered separately, see pages 179, 180, 182 and 183.

**To Order, Specify:**

- 1) Product number.  
–Specify edge detail as **9th digit** in product number.
  - 1 Square edge
  - 2 Bevel edge
  - 3 Chamfer edge
  - 4 Radius edge
- 2) Wood finish color.
- 3) Plastic laminate finish color (if specified).

	Size	No. of Pieces	Seating Capacity	Power Cut-Out Option	Number	Wood Finish Group/ Laminate Top			
						1	2	3	4
<b>Rectangle Top</b>	42" x 84"(1067mm x 2134mm)	1	4	S	CTRC-4284-	\$2002	\$2107	\$2212	\$2528
	48" x 96"(1219mm x 2438mm)	2	8	S	CTRC-4896-	2577	2713	2849	3256
	48" x 117"(1219mm x 2972mm)	2	10	S	CTRC-4817-	3285	3458	3631	4150
	48" x 146"(1219mm x 3708mm)	2	12	D	CTRC-4846-	4201	4422	4643	5306
	48" x 168"(1219mm x 4267mm)	2	14	D	CTRC-4868-	4625	4868	5111	5842



CTRC

- Wood veneer or plastic laminate top.
- Solid wood edge.
- Bases ordered separately, see pages 179, 180, 182 and 183.

**To Order, Specify:**

- 1) Product number.  
–Specify edge detail as **9th digit** in product number.
  - 1 Square edge
  - 2 Bevel edge
  - 3 Chamfer edge
  - 4 Radius edge
- 2) Wood finish color.
- 3) Plastic laminate finish color (if specified).

**Power Hatch Cut-Out Option:**

Specification of Power Hatch Cut-Out requires modification of product number and price. Cut-out(s) will be centered between bases.

One cut-out, add **-S** to end of product number and add **\$100** list.  
Two cut-outs, add **-D** to end of product number and add **\$200** list.

**Example:** CTRC-4284-1S.



**NOTE:**

Order separately specified power hatches and cable management from pages 194-195.

## Series K/Profile/Tripoli Bases by SMED

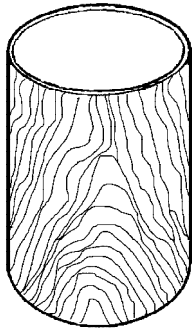
Top Shape	Top Series	Top Size	Base Qty. and Size	Number	Wood Finish Group					
					1	2	3	4		
<b>18"(457mm)/ 24"(610mm) Diameter Cylinder Bases</b>    SBYB	Boat	Tripoli / Profile	48" x 96"(1219mm x 2438mm)	2-18"(457mm)	SBYA-96BO	\$1879	\$1978	\$2077	\$2374	
			48" x 117"(1219mm x 2972mm)	2-18"(457mm)	SBYA-17BO	1879	1978	2077	2374	
			48" x 146"(1219mm x 3708mm)	3-18"(457mm)	SBYA-46BO	2667	2807	2947	3368	
			48" x 168"(1219mm x 4267mm)	3-18"(457mm)	SBYA-68BO	2667	2807	2947	3368	
	Round	Series K	53"(1346mm)	1-24"(610mm)	SBYB-53RO	\$1237	\$1302	\$1367	\$1562	
			60"(1524mm)	1-24"(610mm)	SBYB-60RO	1237	1302	1367	1562	
		Tripoli/Profile	36"(914mm)	1-18"(457mm)	SBYA-36RO	935	984	1033	1181	
			42"(1067mm)/48"(1219mm)	1-24"(610mm)	SBYB-48RO	1237	1302	1367	1562	
			54"(1372mm)	1-24"(610mm)	SBYB-54RO	1237	1302	1367	1562	
			60"(1524mm)	1-24"(610mm)	SBYB-60RO	1237	1302	1367	1562	
		Racetrack	Series K	53" x 96"(1346mm x 2438mm)	2-24"(610mm)	SBYB-96RT	\$2425	\$2553	\$2681	\$3064
				60" x 120"(1524mm x 3047mm)	2-24"(610mm)	SBYB-12RT	2425	2553	2681	3064
				53" x 143"(1346mm x 3632mm)	3-24"(610mm)	SBYB-43RT	3638	3830	4022	4596
				60" x 143"(1524mm x 3632mm)	3-24"(610mm)	SBYB-43RT	3638	3830	4022	4596
				53" x 167"(1346mm x 4242mm)	3-24"(610mm)	SBYB-67RT	3638	3830	4022	4596
				60" x 167"(1524mm x 4242mm)	3-24"(610mm)	SBYB-67RT	3638	3830	4022	4596
53" x 191"(1346mm x 4851mm)	3-24"(610mm)			SBYB-91RT	3638	3830	4022	4596		
60" x 214"(1524mm x 5436mm)	3-24"(610mm)			SBYB-14RT	3638	3830	4022	4596		
Tripoli/Profile	60" x 238"(1524mm x 6045mm)		3-24"(610mm)	SBYB-38RT	3638	3830	4022	4596		
	48" x 96"(1219mm x 2438mm)		2-18"(457mm)	SBYA-96RT	\$1879	\$1978	\$2077	\$2374		
	48" x 117"(1219mm x 2972mm)		2-18"(457mm)	SBYA-17RT	1879	1978	2077	2374		
	48" x 146"(1219mm x 3708mm)		3-18"(457mm)	SBYA-46RT	2667	2807	2947	3368		
Square	Tripoli/Profile	36" x 36"(914mm x 914mm)	1-18"(457mm)	SBYA-36SQ	\$ 935	\$ 984	\$1033	\$1181		
		42" x 42"(1067mm x 1067mm)	1-24"(610mm)	SBYB-42SQ	1237	1302	1367	1562		
Rectangle	Series K	53" x 97"(1346mm x 2464mm)	2-24"(610mm)	SBYB-97RE	\$2425	\$2553	\$2681	\$3064		
		53" x 121"(1346mm x 3073mm)	2-24"(610mm)	SBYB-21RE	2425	2553	2681	3064		
		60" x 121"(1524mm x 3073mm)	2-24"(610mm)	SBYB-21RE	2425	2553	2681	3064		
		53" x 144"(1346mm x 3656mm)	3-24"(610mm)	SBYB-44RE	3638	3830	4022	4596		
		60" x 144"(1524mm x 3656mm)	3-24"(610mm)	SBYB-44RE	3638	3830	4022	4596		
		60" x 168"(1524mm x 4267mm)	3-24"(610mm)	SBYB-68RE	3638	3830	4022	4596		
		60" x 192"(1524mm x 4877mm)	3-24"(610mm)	SBYB-92RE	3638	3830	4022	4596		
		60" x 215"(1524mm x 5461mm)	3-24"(610mm)	SBYB-15RE	3638	3830	4022	4596		
	Tripoli/Profile	60" x 239"(1524mm x 6071mm)	3-24"(610mm)	SBYB-39RE	3638	3830	4022	4596		
		48" x 96"(1219mm x 2438mm)	2-18"(457mm)	SBYA-96RE	\$1879	\$1978	\$2077	\$2374		
		48" x 117"(1219mm x 2972mm)	2-18"(457mm)	SBYA-17RE	1879	1978	2077	2374		
		48" x 146"(1219mm x 3708mm)	3-18"(457mm)	SBYA-46RE	2667	2807	2947	3368		
Rectangle	Tripoli/Profile	48" x 168"(1219mm x 4267mm)	3-18"(457mm)	SBYA-68RE	2667	2807	2947	3368		

- 18"(457mm) or 24"(610mm) diameter cylinder.
- Wood veneer (over wood base).
- Tops ordered separately, see pages 172-178.
- Installation hardware provided.
- Each wood base requires 100 lbs. of weight (to be provided by the customer).
- Cylinder bases with integral power access door are available as a special.

**To Order, Specify:**

- 1) Product number.  
(NOTE: Product number and list price include proper quantity of bases.)
- 2) Wood finish and color.

# Series K/Profile/Tripoli Bases by SMED

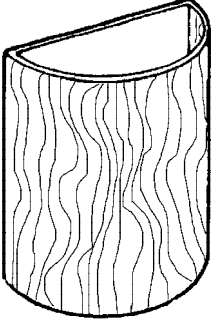
	Top Shape	Top Series	Top Size	Base Qty. and Size	Number	Wood Finish Group					
						1	2	3	4		
<b>18"(457mm)/ 24"(610mm) Diameter Half-Cylinder Bases</b>	Boat	Tripoli / Profile	48" x 96"(1219mm x 2438mm)	2-18"(457mm)	SBYH-96BO	\$2037	\$2144	\$2251	\$2573		
			48" x 117"(1219mm x 2972mm)	2-18"(457mm)	SBYH-17BO	2037	2144	2251	2573		
			48" x 146"(1219mm x 3708mm)	2-18"(457mm)	SBYH-46BO	2703	2845	2987	3414		
				1-18"(457mm) cylinder							
			48" x 168"(1219mm x 4267mm)	2-18"(457mm)	SBYH-68BO	2703	2845	2987	3414		
				1-18"(457mm) cylinder							
	 SBYI	Racetrack	Series K	53" x 96"(1346mm x 2438mm)	2-24"(610mm)	SBYI-96RT	\$2632	\$2771	\$2910	\$3325	
				60" x 120"(1524mm x 3047mm)	2-24"(610mm)	SBYI-20RT	2632	2771	2910	3325	
				53" X 143"(1346mm x 3632mm)	2-24"(610mm)	SBYI-43RT	3394	3573	3752	4288	
					1-24"(610mm) cylinder						
				60" x 143"(1524mm x 3632mm)	2-24"(610mm)	SBYI-43RT	3394	3573	3752	4288	
					1-24"(610mm) cylinder						
Tripoli / Profile		Series K	Tripoli / Profile	48" x 96"(1219mm x 2438mm)	2-18"(457mm)	SBYH-96RT	\$2037	\$2144	\$2251	\$2573	
				48" x 117"(1219mm x 2972mm)	2-18"(457mm)	SBYH-17RT	2037	2144	2251	2573	
				48" x 146"(1219mm x 3708mm)	2-18"(457mm)	SBYH-46RT	2703	2845	2987	3414	
					1-18"(457mm) cylinder						
				48" x 168"(1219mm x 4267mm)	2-18"(457mm)	SBYH-68RT	2703	2845	2987	3414	
					1-18"(457mm) cylinder						
Rectangle	Series K	Series K	53" x 97"(1346mm x 2464mm)	2-24"(610mm)	SBYI-97RE	\$2632	\$2771	\$2910	\$3325		
			53" x 121"(1346mm x 3073mm)	2-24"(610mm)	SBYI-21RE	2632	2771	2910	3325		
			60" x 121"(1524mm x 3073mm)								
			53" x 144"(1346mm x 3658mm)	2-24"(610mm)	SBYI-44RE	3394	3573	3752	4288		
			60" x 144"(1524mm x 3658mm)	1-24"(610mm) cylinder							
	Tripoli / Profile	Series K	Tripoli / Profile	48" x 96"(1219mm x 2438mm)	2-18"(457mm)	SBYH-96RE	\$2037	\$2144	\$2251	\$2573	
				48" x 117"(1219mm x 2972mm)	2-18"(457mm)	SBYH-17RE	2037	2144	2251	2573	
				48" x 146"(1219mm x 3708mm)	2-18"(457mm)	SBYH-46RE	2703	2845	2987	3414	
					1-18"(457mm) cylinder						
				48" x 168"(1219mm x 4267mm)	2-18"(457mm)	SBYH-68RE	2703	2845	2987	3414	
					1-18"(457mm) cylinder						

- Wood veneer (over wood base).
- Tops ordered separately, see pages 172-178.
- Installation hardware provided.
- Each wood base requires 100 lbs. of weight (to be provided by the customer).

**To Order, Specify:**

- 1) Product number.  
(NOTE: Product number and list price include proper quantity of bases.)
- 2) Wood finish and color.

## Series K/Profile/Tripoli Bases by SMED

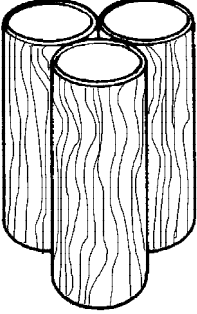
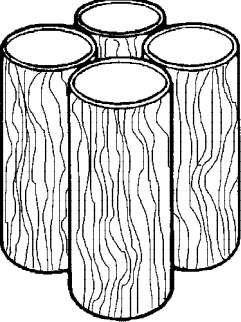
	Top Shape	Top Series	Top Size	Base Qty. and Size	Number	Wood Finish Group					
						1	2	3	4		
<b>12''(305mm)/ 16''(406mm) Diameter Cluster Base</b>   SBY3   SBY4	Round	Series K	53''(1346mm)	1-12''(305mm) 3 cluster	SBY3-53RO	\$1527	\$1607	\$1687	\$1928		
			60''(1524mm)	1-12''(305mm) 3 cluster	SBY3-60RO	1527	1607	1687	1928		
			Tripoli / Profile	54''(1372mm)	1-12''(305mm) 3 cluster	SBY3-54RO	1527	1607	1687	1928	
				60''(1524mm)	1-12''(305mm) 3 cluster	SBY3-60RO	1527	1607	1687	1928	
			Racetrack	Series K	53'' x 143''(1346mm x 3632mm)	3-12''(305mm) 3 cluster	SBY3-43RT	\$4581	\$4822	\$5063	\$5786
					60'' x 143''(1524mm x 3632mm)	3-12''(305mm) 3 cluster	SBY3-43RT	4581	4822	5063	5786
	53'' x 167''(1346mm x 4242mm)	3-12''(305mm) 3 cluster			SBY3-67RT	4581	4822	5063	5786		
	60'' x 167''(1524mm x 4242mm)	3-12''(305mm) 3 cluster			SBY3-67RT	4581	4822	5063	5786		
				53'' x 191''(1346mm x 4851mm)	2-12''(305mm) 3 cluster 1-12''(305mm) 4-cluster	SBY3-91RT	5429	5715	6001	6858	
				60'' x 214''(1524mm x 5436mm)	2-12''(305mm) 3 cluster 1-12''(305mm) 4 cluster	SBY3-14RT	5429	5715	6001	6858	
60'' x 238''(1524mm x 6045mm)				2-12''(305mm) 3 cluster 1-12''(305mm) 4 cluster	SBY3-38RT	5429	5715	6001	6858		
Square				Tripoli / Profile	54'' x 54''(1372mm x 1372mm)	1-16''(406mm) 4 cluster	SBY4-54SQ	\$3235	\$3405	\$3575	\$4086
60'' x 60''(1524mm x 1524mm)	1-16''(406mm) 4 cluster	SBY4-60SQ	3235		3405	3575	4086				
Rectangle	Series K	53'' x 121''(1346mm x 3073mm), 60'' x 121''(1524mm x 3073mm)	2-12''(305mm) 3 cluster	SBY3-21RE	\$3056	\$3217	\$3378	\$3860			
		53'' x 144''(1346mm x 3658mm), 60'' x 144''(1524mm x 3658mm)	3-12''(305mm) 3 cluster	SBY3-44RE	4581	4822	5063	5786			
		53'' x 168''(1346mm x 4267mm), 60'' x 168''(1524mm x 4267mm)	3-12''(305mm) 3 cluster	SBY3-68RE	4581	4822	5063	5786			
		60'' x 192''(1524mm x 4877mm)	2-12''(305mm) 3 cluster 1-12''(305mm) 4 cluster	SBY3-92RE	5429	5715	6001	6858			
		60'' x 215''(1524mm x 5461mm)	2-12''(305mm) 3 cluster 1-12''(305mm) 4 cluster	SBY3-15RE	5429	5715	6001	6858			
		60'' x 239''(1524mm x 6071mm)	2-12''(305mm) 3 cluster 1-12''(305mm) 4 cluster	SBY3-39RE	5429	5715	6001	6858			

- Three 12''(305mm), four 12''(305mm), or four 16''(406mm) diameter cylinders.
- Wood veneer (over wood base).
- Fastened together in clusters.
- Installation hardware provided.
- Tops ordered separately, see pages 172-178.

**To Order, Specify:**

- 1) Product number.  
(NOTE: Product number and list price include proper quantity of bases.)
- 2) Wood finish and color.

# Series K/Profile/Tripoli Bases by SMED

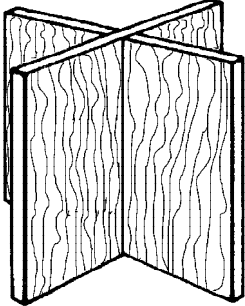
	Top Shape	Top Series	Top Size	Base Qty. and Size	Number	Wood Finish Group				
						1	2	3	4	
<b>24''(610mm)/ 30''(762mm) Wide X Base</b>  	Boat	Tripoli / Profile	48'' x 96''(1219mm x 2438mm)	2-24''(610mm)	SBX-96BO	\$1681	\$1770	\$1859	\$2124	
			48'' x 117''(1219mm x 2972mm)	2-24''(610mm)	SBX-17BO	1681	1770	1859	2124	
			48'' x 146''(1219mm x 3708mm)	3-24''(610mm)	SBX-46BO	2523	2656	2789	3187	
			48'' x 168''(1219mm x 4267mm)	3-24''(610mm)	SBX-68BO	2523	2656	2789	3187	
	Round	Series K	53''(1346mm)	1-30''(762mm)	SBW-53RO	\$ 900	\$ 947	\$ 994	\$1136	
			60''(1524mm)	1-30''(762mm)	SBW-60RO	900	947	994	1136	
		Tripoli / Profile	36''(914mm)	1-24''(610mm)	SBX-36RO	842	886	930	1063	
			42''(1067mm)	1-24''(610mm)	SBX-42RO	842	886	930	1063	
			48''(1219mm)	1-24''(610mm)	SBX-48RO	842	886	930	1063	
			54''(1372mm)	1-30''(762mm)	SBW-54RO	900	947	994	1136	
			60''(1524mm)	1-30''(762mm)	SBW-60RO	900	947	994	1136	
			Racetrack	Series K	53'' x 96''(1346mm x 2438mm)	2-24''(610mm)	SBX-96RT	\$1681	\$1770	\$1859
		60'' x 120''(1524mm x 3048mm)			2-30''(762mm)	SBW-20RT	1799	1894	1989	2273
		53'' x 143''(1346mm x 3632mm)			3-24''(610mm)	SBX-43RT	2523	2656	2789	3187
		60'' x 143''(1524mm x 3632mm)			3-30''(762mm)	SBW-43RT	2700	2842	2984	3410
		53'' x 167''(1346mm x 4242mm)			3-24''(610mm)	SBX-67RT	2523	2656	2789	3187
60'' x 167''(1524mm x 4242mm)	3-30''(762mm)	SBW-67RT			2700	2842	2984	3410		
53'' x 191''(1346mm x 4851mm)	3-24''(610mm)	SBX-91RT			2523	2656	2789	3187		
60'' x 214''(1524mm x 5436mm)	3-30''(762mm)	SBW-14RT			2700	2842	2984	3410		
60'' x 238''(1524mm x 6045mm)	3-30''(762mm)	SBW-38RT			2700	2842	2984	3410		
Tripoli / Profile	48'' x 96''(1219mm x 2438mm)	2-24''(610mm)			SBX-96RT	\$1681	\$1770	\$1859	\$2124	
	48'' x 117''(1219mm x 2972mm)	2-24''(610mm)	SBX-17RT	1681	1770	1859	2124			
	48'' x 146''(1219mm x 3708mm)	3-24''(610mm)	SBX-46RT	2523	2656	2789	3187			
	48'' x 168''(1219mm x 4267mm)	3-24''(610mm)	SBX-68RT	2523	2656	2789	3187			
Square	Tripoli / Profile	36'' x 36''(914mm x 914mm)	1-24''(610mm)	SBX-36SQ	\$ 842	\$ 886	\$ 930	\$1063		
		42'' x 42''(1067mm x 1067mm)	1-24''(610mm)	SBX-42SQ	842	886	930	1063		
		48'' x 48''(1219mm x 1219mm)	1-30''(762mm)	SBW-48SQ	900	947	994	1136		
Rectangle	Series K	53'' x 121''(1346mm x 3073mm)	2-24''(610mm)	SBX-21RE	\$1681	\$1770	\$1859	\$2124		
		60'' x 121''(1524mm x 3073mm)	2-30''(762mm)	SBW-21RE	1799	1894	1989	2273		
		53'' x 144''(1346mm x 3658mm)	3-24''(610mm)	SBX-44RE	2523	2656	2789	3187		
		60'' x 144''(1524mm x 3658mm)	3-30''(762mm)	SBW-44RE	2700	2842	2984	3410		
		60'' x 168''(1524mm x 4267mm)	3-30''(762mm)	SBW-68RE	2700	2842	2984	3410		
		60'' x 192''(1524mm x 4877mm)	3-30''(762mm)	SBW-92RE	2700	2842	2984	3410		
		60'' x 215''(1524mm x 5461mm)	3-30''(762mm)	SBW-15RE	2700	2842	2984	3410		
		60'' x 239''(1524mm x 6071mm)	3-30''(762mm)	SBW-39RE	2700	2842	2984	3410		
		Tripoli / Profile	48'' x 96''(1219mm x 2438mm)	2-24''(610mm)	SBX-96RE	\$1681	\$1770	\$1859	\$2124	
			48'' x 117''(1219mm x 2972mm)	2-24''(610mm)	SBX-17RE	1681	1770	1859	2124	
			48'' x 146''(1219mm x 3708mm)	3-24''(610mm)	SBX-46RE	2523	2656	2789	3187	
			48'' x 168''(1219mm x 4267mm)	3-24''(610mm)	SBX-68RE	2523	2656	2789	3187	

SBW  
SBX

- 24''(610mm) or 30''(762mm) X-shaped base.
- Wood veneer finish.
- Tops ordered separately, see pages 172-178.
- Shipped knocked down.

**To Order, Specify:**

- 1) Product number.  
(NOTE: Product number and list price include proper quantity of bases.)
- 2) Wood finish color.

## Series K/Profile/Tripoli Bases by SMED

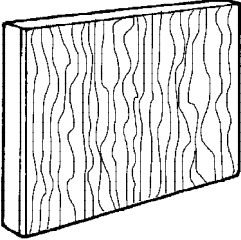
	Top Shape	Top Series	Top Size	Base Qty. and Size	Number	Wood Finish Group				
						1	2	3	4	
<b>30''(762mm) Wide Slab Base</b>  SBS	Boat	Tripoli / Profile	42'' x 84''(1067mm x 2134mm)	2-30''(762mm)	SBS-84BO	\$ 802	\$ 844	\$ 886	\$1013	
			48'' x 96''(1219mm x 2438mm)	2-30''(762mm)	SBS-96BO	802	844	886	1013	
			48'' x 117''(1219mm x 2972mm)	2-30''(762mm)	SBS-17BO	802	844	886	1013	
			48'' x 146''(1219mm x 3708mm)	3-30''(762mm)	SBS-46BO	1200	1263	1326	1516	
			48'' x 168''(1219mm x 4267mm)	3-30''(762mm)	SBS-68BO	1200	1263	1326	1516	
	Racetrack	Tripoli / Profile	42'' x 84''(1067mm x 2134mm)	2-30''(762mm)	SBS-84RT	\$ 802	\$ 844	\$ 886	\$1013	
			48'' x 96''(1219mm x 2438mm)	2-30''(762mm)	SBS-96RT	802	844	886	1013	
			48'' x 117''(1219mm x 2972mm)	2-30''(762mm)	SBS-17RT	802	844	886	1013	
			48'' x 146''(1219mm x 3708mm)	3-30''(762mm)	SBS-46RT	1200	1263	1326	1516	
			48'' x 168''(1219mm x 4267mm)	3-30''(762mm)	SBS-68RT	1200	1263	1326	1516	
	Rectangle	Series K	53'' x 121''(1346mm x 3073mm), 60'' x 121''(1524mm x 3073mm)	2-30''(762mm)	SBS-21RE	\$ 802	\$ 844	\$ 886	\$1013	
			53'' x 144''(1346mm x 3658mm), 60'' x 144''(1524mm x 3658mm)	3-30''(762mm)	SBS-44RE	1200	1263	1326	1516	
			60'' x 168''(1524mm x 4267mm)	3-30''(762mm)	SBS-68RE	1200	1263	1326	1516	
			60'' x 192''(1524mm x 4877mm)	3-30''(762mm)	SBS-92RE	1200	1263	1326	1516	
			60'' x 215''(1524mm x 5461mm)	4-30''(762mm)	SBS-15RE	1602	1686	1770	2023	
			60'' x 239''(1524mm x 6071mm)	4-30''(762mm)	SBS-39RE	1602	1686	1770	2023	
			Tripoli / Profile	42'' x 84''(1067mm x 2134mm)	2-30''(762mm)	SBS-84RE	802	844	886	1013
				48'' x 96''(1219mm x 2438mm)	2-30''(762mm)	SBS-96RE	802	844	886	1013
				48'' x 117''(1219mm x 2972mm)	2-30''(762mm)	SBS-17RE	802	844	886	1013
				48'' x 146''(1219mm x 3708mm)	3-30''(762mm)	SBS-46RE	1200	1263	1326	1516
48'' x 168''(1219mm x 4267mm)	3-30''(762mm)	SBS-68RE	1200	1263	1326	1516				

- 30''(762mm) wide and 2 3/16''(56mm) thick slab.
- Wood veneer finish.
- Tops ordered separately, see pages 172-178.

**To Order, Specify:**

- 1) Product number.  
(NOTE: Product number and list price include proper quantity of bases.)
- 2) Wood finish color.



# Tripoli Bases by SMED

	Top Shape	Top Series	Top Size	Base Qty. and Size	Number	Price
<b>Metal X Base</b>	Round	Tripoli	36"(914mm)	1-15"(381mm)	TRTB-36RO	<b>\$259</b>
			42"(1067mm)	1-21"(533mm)	TRTB-42RO	<b>259</b>
			48"(1219mm)	1-21"(533mm)	TRTB-48RO	<b>259</b>
	Square		36"(914mm)	1-15"(381mm)	TRTB-36SQ	<b>\$259</b>

- Painted metal base.
- Available **only** on Tripoli tops.
- Top ordered separately, see page 177.
- Standard in charcoal finish color only.

**To Order, Specify:**

- 1) Product number.  
(No finish specification required.)

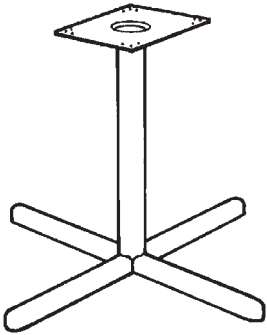

TRTB



## Varia Tables by SMED

---

### Product Offering

The Varia conference table offering consists of the following:

#### Tops

Varia Modern Edge Table Tops  
 Varia Classic Edge Table Tops  
 Varia Traditional Edge Table Tops

#### Bases

Slab Bases  
 X and L Bases  
 Cylinder Bases

Varia conference table tops and bases are specified separately.

---

### Table Top Features

Standard table top materials are Anegre veneer with Agathis hardwood edges.

Other special top materials include the following:

- Plastic laminate inset with Agathis edge.
  - Stone tops will feature a stone inset with Agathis hardwood edges.
- 

### Table Base Features

Table bases are available in quarter-cut and Pinched Anegre.

Cylinder Bases require customer-supplied, field-installed weights. Recommended weights, which vary depending on the base style and size, are provided in the price pages.

Leveling glides are included on all bases.

Appropriate base sizes for each top size/shape combination are provided in the price pages.

**Product number for table base determines correct number of bases required for top.**

# Varia Tables by SMED

## General Information

Tops and bases are packed separately for shipping. Field assembly of conference table top and bases is required. Instructions are provided with bases.

Wood and high-pressure laminate tops longer than 120"(3048mm) are constructed of two or more separate pieces and are connected by two level locks per joint.

Custom-size tops are available. Pricing for custom table tops is available from your Order Services Coordinator.

Before ordering table tops, be certain that the entrances and elevators at the installation site can accommodate large table tops.

## Edge Details

Varia conference table tops may be specified with various edge details.

Varia Classic-1

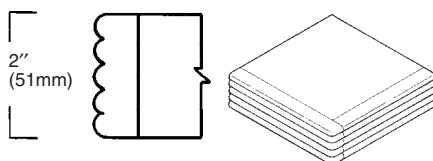

Varia Modern-2

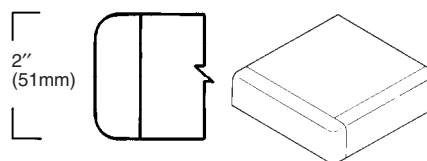

Varia Traditional-4

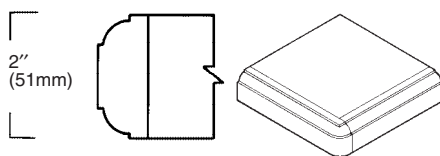

## Base Heights and Finished Table Heights

Base heights and finished table heights are as follows:

Base	Base Height	Finish Height Wood Top	Finish Height Stone Top
Slab	27 7/8"(707mm)	29 7/8"(758mm)	30 5/8"(777mm)
X	27 7/8"(707mm)	29 7/8"(758mm)	30 5/8"(777mm)
L	27 7/8"(707mm)	29 7/8"(758mm)	30 5/8"(777mm)
Cylinder	27 7/8"(707mm)	29 7/8"(758mm)	30 5/8"(777mm)

## Wood/Finish Features

Conference table tops are constructed of Anegre veneers with Agathis hardwood edges.

All standard table top finishes include a minimum of two top coats of conversion varnish that creates an extremely durable finish.

All wood bases are open-pore.

## Grain Direction

The standard grain direction on all conference table tops runs across the table.

Cross Grain (Standard)

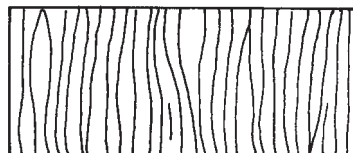

# Varia Tables by SMED

## Seating Capacity

The following seating capacities are approximate and will vary based on the desired amount of leg space and space between chairs. To ensure appropriate sizing and spacing, Haworth recommends that a drawing of the conference table and chairs be created and reviewed prior to specification.

The following seating capacity chart is based on 25"(635mm)-wide chairs:

Table Shape	Table Size	Approximate Seating Capacity
Round	36"(914mm)	3
	42"(1067mm)	4
	48"(1219mm)	5
	60"(1524mm)	7
Rectangle, Boat or Racetrack	72"(1829mm) x 42"(1067mm)	6
	96"(2438mm) x 48"(1219mm)	8
	120"(3048mm) x 48"(1219mm)	10
	144"(3658mm) x 48"(1219mm)	12
	168"(4267mm) x 60"(1524mm)	12-14
	192"(4877mm) x 60"(1524mm)	14
	216"(5486mm) x 60"(1524mm)	16
240"(6096mm) x 60"(1524mm)	18	

## Special Top Inset Codes

The following list of finish codes represent the special top insets. Refer to the price charts for the availability of each inset material on a specific top. Refer to the designated pages for complete finish codes and color names.

Code	Description
Laminate	Plastic laminate inset top
S1	Stone inset top, page 209
S2	Stone inset top, page 209

## General Guidelines for Product Specification

Varia conference table top and base product specification numbers are based on an alpha-numeric logic that identifies a product by shape, size, and certain characteristics.

For example, a product number that reads **ABCT-7242-2** identifies the product as a racetrack table top with Varia Modern edge, 72"(1829mm) long, and 42"(1067mm) wide.

The alpha-numeric logic for this product with finish codes is shown below:

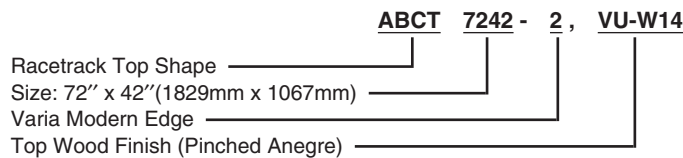

Beyond the printed product number, wood finish codes and special inset finish codes are required to complete an order specification. To communicate your order clearly, list the product number and finish codes in the sequence outlined on each page of the price list.

## Finishes

A complete listing of finishes for conference table tops and bases can be found on pages 207-209.

# Varia Table Tops by SMED

Shape	Size	No. of Pieces Wood/Stone	Power Cut-out Option	Number	Wood Finish Group		Special Top Inset Laminate	Stone Inset	
					3	4		S1	S2
 ABCR	36"(914mm)	1/1	N/A	ABCR-36-	\$1834	\$1926	\$1944	\$3668	\$5777
	42"(1067mm)	1/1	N/A	ABCR-42-	2946	3093	3123	5538	8190
	48"(1219mm)	1/1	N/A	ABCR-48-	3112	3268	3299	5851	8651
	60"(1524mm)	1/2	N/A	ABCR-60-	3338	3505	3538	6275	9280

- Available with Anegre veneer and Agathis edge.
- Bases ordered separately, see pages 191 and 193.

**To Order, Specify:**

- 1) Product number.  
–Specify edge detail as **7th digit** in product number.
  - 1** Classic
  - 2** Modern
  - 4** Traditional
- 2) Wood finish color (Anegre).
- 3) Laminate or stone inset (if applicable).

Shape	Size	No. of Pieces Wood/Stone	Power Cut-out Option	Number	Wood Finish Group		Special Top Inset Laminate	Stone Inset	
					3	4		S1	S2
 ABCB	72" x 42"/30"(1829mm x 1067mm/762mm)	1/1	S	ABCB-7242-	\$ 3484	\$ 3658	\$ 3693	\$ 6968	\$10452
	96" x 48"/32"(2438mm x 1219mm/813mm)	1/2	S	ABCB-9648-	4884	5128	5177	9768	14652
	120" x 48"/32"(3048mm x 1219mm/813mm)	1/2	S	ABCB-1048-	5296	5561	5614	10592	15888
	144" x 48"/32"(3658mm x 1219mm/813mm)	2/2	D	ABCB-1248-	6892	7237	7299	12220	18329
	168" x 60"/42"(4267mm x 1524mm/1067mm)	4/4	D	ABCB-1460-	11479	12053	12176	20362	30547
	192" x 60"/42"(4877mm x 1524mm/1067mm)	4/4	D	ABCB-1660-	13990	14690	14874	21280	31922
	216" x 60"/42"(5486mm x 1524mm/1067mm)	5/5	D	ABCB-1860-	15752	16540	16694	23955	35932
	240" x 60"/42"(6096mm x 1524mm/1067mm)	5/5	D	ABCB-2060-	17389	18258	18427	26449	40548

- Available with Anegre veneer and Agathis edge.
- Bases ordered separately, see pages 190, 192 and 193.

**To Order, Specify:**

- 1) Product number.  
–Specify edge detail as **9th digit** in product number.
  - 1** Classic
  - 2** Modern
  - 4** Traditional
- 2) Wood finish color (Anegre).
- 3) Laminate or stone inset (if applicable).

**Power Hatch Cut-Out Option:**

Specification of Power Hatch Cut-Out requires modification of product number and price. Cut-out(s) will be centered between bases.

One cut-out, add **-S** to end of product number and add **\$100** list.  
Two cut-outs, add **-D** to end of product number and add **\$200** list.

**Example:** ABCB-7242-1S.



**NOTE:**

Order separately specified power hatches and cable management from pages 194-195.  
Stone tops do not accommodate the power hatch cut-out option.

# Varia Table Tops by SMED

Shape	Size	No. of Pieces Wood/Stone	Power Cut-out Option	Number	Wood Finish Group		Special Top Inset Laminate	Stone Inset	
					3	4		S1	S2
 ABCT	72" x 42"(1829mm x 1067mm)	1/1	S	ABCT-7242-	\$ 3657	\$ 3840	\$ 3876	\$ 7314	\$10971
	96" x 48"(2438mm x 1219mm)	1/2	S	ABCT-9648-	5144	5401	5453	10288	15432
	120" x 48"(3048mm x 1219mm)	1/2	S	ABCT-1048-	5563	5841	5897	11126	16689
	144" x 48"(3658mm x 1219mm)	2/2	D	ABCT-1248-	8892	9337	9426	15739	23653
	168" x 60"(4267mm x 1524mm)	4/4	D	ABCT-1460-	9988	10487	10589	17723	26578
	192" x 60"(4877mm x 1524mm)	4/4	D	ABCT-1660-	12175	12784	12895	18508	27764
	216" x 60"(5486mm x 1524mm)	5/5	D	ABCT-1860-	13694	14379	14515	20830	31244
	240" x 60"(6096mm x 1524mm)	5/5	D	ABCT-2060-	15116	15872	16028	23008	34512

- Available with Anegre veneer and Agathis edge.
- Bases ordered separately, see pages 190, 192 and 193.

**To Order, Specify:**

- 1) Product number.  
–Specify edge detail as **9th digit** in product number.
  - 1** Classic
  - 2** Modern
  - 4** Traditional
- 2) Wood finish color (Anegre).
- 3) Laminate or stone inset (if applicable).

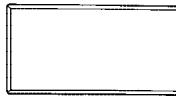
 ABCE	72" x 42"(1829mm x 1067mm)	1/1	S	ABCE-7242-	\$ 3414	\$ 3585	\$ 3619	\$ 6828	\$10240
	96" x 48"(2438mm x 1219mm)	1/2	S	ABCE-9648-	4786	5025	5073	9572	14358
	120" x 48"(3048mm x 1219mm)	1/2	S	ABCE-1048-	5190	5450	5501	10380	15570
	144" x 48"(3658mm x 1219mm)	2/2	D	ABCE-1248-	6754	7092	7159	11955	17966
	168" x 60"(4267mm x 1524mm)	4/4	D	ABCE-1460-	11249	11811	11924	19911	29922
	192" x 60"(4877mm x 1524mm)	4/4	D	ABCE-1660-	13710	14396	14533	20839	31259
	216" x 60"(5486mm x 1524mm)	5/5	D	ABCE-1860-	15437	16209	16363	23464	35196
	240" x 60"(6096mm x 1524mm)	5/5	D	ABCE-2060-	17041	17893	18063	25902	38853

- Available with Anegre veneer and Agathis edge.
- Bases ordered separately, see pages 190, 191 and 193.

**To Order, Specify:**

- 1) Product number.  
–Specify edge detail as **9th digit** in product number.
  - 1** Classic
  - 2** Modern
  - 4** Traditional
- 2) Wood finish color (Anegre).
- 3) Laminate or stone inset (if applicable).

**Power Hatch Cut-Out Option:**

Specification of Power Hatch Cut-Out requires modification of product number and price. Cut-out(s) will be centered between bases.

One cut-out, add **-S** to end of product number and add **\$100** list.  
Two cut-outs, add **-D** to end of product number and add **\$200** list.  
**Example:** ABCE-7242-1S.

**NOTE:**

Order separately specified power hatches and cable management from pages 194-195.  
Stone tops do not accommodate the power hatch cut-out option.

# Varia Slab Table Bases by SMED

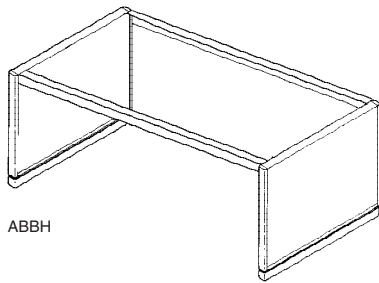

ABBH

Top Shape	Top Size	Base Quantity and Size	Number	Wood Finish Group	
				3	4
Rectangle	72" x 42"(1829mm x 1067mm)	2-24"(610mm)	ABBH-72RE-	\$1743	\$1830
	96" x 48"(2438mm x 1219mm)	2-24"(610mm)	ABBH-96RE-	1822	1913
	120" x 48"(3048mm x 1219mm)	2-24"(610mm)	ABBH-10RE-	1941	2038
	144" x 48"(3658mm x 1219mm)	3-24"(610mm)	ABBH-12RE-	2863	3006
	168" x 60"(4267mm x 1524mm)	3-30"(762mm)	ABBH-14RE-	3255	3418
	192" x 60"(4877mm x 1524mm)	3-30"(762mm)	ABBH-16RE-	3386	3555
	216" x 60"(5486mm x 1524mm)	4-30"(762mm)	ABBH-18RE-	4356	4574
	240" x 60"(6096mm x 1524mm)	4-30"(762mm)	ABBH-20RE-	4487	4711
Boat	72" x 42"(1829mm x 1067mm)	2-24"(610mm)	ABBH-72BO-	\$1743	\$1830
	96" x 48"(2438mm x 1219mm)	2-24"(610mm)	ABBH-96BO-	1822	1913
	120" x 48"(3048mm x 1219mm)	2-24"(610mm)	ABBH-10BO-	1941	2038
	144" x 48"(3658mm x 1219mm)	3-24"(610mm)	ABBH-12BO-	2863	3006
	168" x 60"(4267mm x 1524mm)	3-30"(762mm)	ABBH-14BO-	3255	3418
	192" x 60"(4877mm x 1524mm)	3-30"(762mm)	ABBH-16BO-	3386	3555
	216" x 60"(5486mm x 1524mm)	4-30"(762mm)	ABBH-18BO-	4356	4574
	240" x 60"(6096mm x 1524mm)	4-30"(762mm)	ABBH-20BO-	4487	4711
Racetrack	72" x 42"(1829mm x 1067mm)	2-24"(610mm)	ABBH-72RT-	\$1743	\$1830
	96" x 48"(2438mm x 1219mm)	2-24"(610mm)	ABBH-96RT-	1822	1913
	120" x 48"(3048mm x 1219mm)	2-24"(610mm)	ABBH-10RT-	1941	2038
	144" x 48"(3658mm x 1219mm)	3-24"(610mm)	ABBH-12RT-	2863	3006
	168" x 60"(4267mm x 1524mm)	3-30"(762mm)	ABBH-14RT-	3255	3418
	192" x 60"(4877mm x 1524mm)	3-30"(762mm)	ABBH-16RT-	3386	3555
	216" x 60"(5486mm x 1524mm)	4-30"(762mm)	ABBH-18RT-	4356	4574
	240" x 60"(6096mm x 1524mm)	4-30"(762mm)	ABBH-20RT-	4487	4711

- Veneer panel-ends with solid wood edge banding in edge detail on sides and bottom.
- Connected by stretchers.
- Available in Anegre veneers and Agathis solids.
- Tops ordered separately, see pages 188-189.

**To Order, Specify:**

- 1) Product number.  
 -Specify base edge detail as **9th digit** in product number.
  - 1** Classic
  - 2** Modern
  - 4** Traditional
- 2) Reveal finish color.
- 3) Wood finish color (Anegre).

# Varia X and L Table Bases by SMED

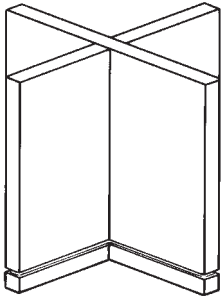
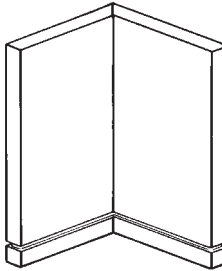
Top Shape	Top Size	Base Quantity and Size	Number	Wood Finish Group	
				3	4
 ABBX	Round 36"(914mm)	1-26"(661mm)	ABBX-36RO-█	\$1512	\$1588
	36"(914mm)	2-10"(254mm)	ABBL-36RO-█	824	865
	42"(1067mm)	1-26"(661mm)	ABBX-42RO-█	1512	1588
	42"(1067mm)	4-10"(254mm)	ABBL-42RO-█	1648	1730
	48"(1219mm)	1-30"(762mm)	ABBX-48RO-█	1676	1760
	48"(1219mm)	4-10"(254mm)	ABBL-48RO-█	1648	1730
	60"(1524mm)	4-10"(254mm)	ABBL-60RO-█	1648	1730
 ABBL	Rectangle 72"(1829mm) x 42"(1067mm)	2-20"(508mm)	ABBX-72RE-█	\$2663	\$2796
	96"(2438mm) x 48"(1219mm)	2-20"(508mm)	ABBX-96RE-█	2663	2796
	120"(3048mm) x 48"(1219mm)	2-30"(762mm)	ABBX-10RE-█	3350	3518
	144"(3658mm) x 48"(1219mm)	1-30"(762mm)(X) & 4-10"(254mm)(L)	ABBX-12RE-█	3323	3489
	168"(4267mm) x 60"(1524mm)	1-30"(762mm)(X) & 4-10"(254mm)(L)	ABBX-14RE-█	3323	3489
	192"(4877mm) x 60"(1524mm)	2-30"(762mm)(X) & 4-10"(254mm)(L)	ABBX-16RE-█	4998	5248
	216"(5486mm) x 60"(1524mm)	2-30"(762mm)(X) & 4-10"(254mm)(L)	ABBX-18RE-█	4998	5248
	240"(6096mm) x 60"(1524mm)	2-30"(762mm)(X) & 4-10"(254mm)(L)	ABBX-20RE-█	4998	5248

- X-panel and L-panel style bases made of veneered panels with solid wood edge banding on ends and detail at bottom of base.
- Available in Anegre veneers and Agathis solids.
- Tops ordered separately, see pages 188-189.

**To Order, Specify:**

- 1) Product number.  
 -Specify base edge detail as **9th digit** in product number.
  - 1 Classic
  - 2 Modern
  - 4 Traditional
- 2) Reveal finish color.
- 3) Wood finish color (Anegre).

**Base Placement:**

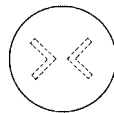

ABBL (quantity 2)

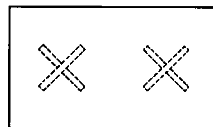

ABBX (quantity 2)

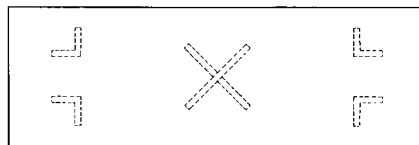

ABBX (quantity 1), ABBL (quantity 4)

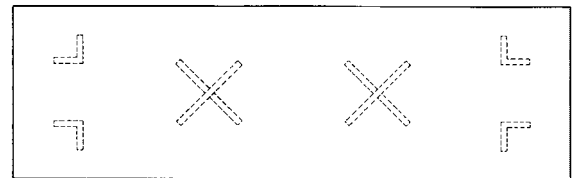

ABBX (quantity 2), ABBL (quantity 4)

# Varia X and L Table Bases by SMED

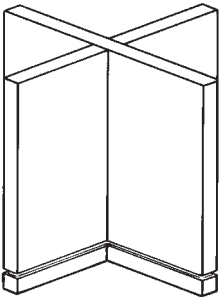
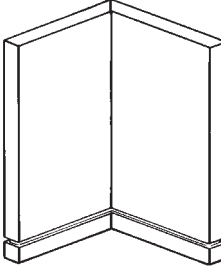
(Continued)	Top Shape	Top Size	Base Quantity and Size	Number	Wood Finish Group	
					3	4
 <p>ABBX</p>	Boat	72" x 42"(1829mm x 1067mm)	2-20"(508mm)	ABBX-72BO-	\$2663	\$2796
		96" x 48"(2438mm x 1219mm)	2-20"(508mm)	ABBX-96BO-	2663	2796
		120" x 48"(3048mm x 1219mm)	2-30"(762mm)	ABBX-10BO-	3350	3518
		144" x 48"(3658mm x 1219mm)	1-30"(762mm)(X) & 4-10"(254mm)(L)	ABBX-12BO-	3323	3489
		168" x 60"(4267mm x 1524mm)	1-30"(762mm)(X) & 4-10"(254mm)(L)	ABBX-14BO-	3323	3489
		192" x 60"(4877mm x 1524mm)	2-30"(762mm)(X) & 4-10"(254mm)(L)	ABBX-16BO-	4998	5248
		216" x 60"(5486mm x 1524mm)	2-30"(762mm)(X) & 4-10"(254mm)(L)	ABBX-18BO-	4998	5248
		240" x 60"(6096mm x 1524mm)	2-30"(762mm)(X) & 4-10"(254mm)(L)	ABBX-20BO-	4998	5248
 <p>ABBL</p>	Racetrack	72" x 42"(1829mm x 1067mm)	2-20"(508mm)	ABBX-72RT-	\$2663	\$2796
		96" x 48"(2438mm x 1219mm)	2-20"(508mm)	ABBX-96RT-	2663	2796
		120" x 48"(3048mm x 1219mm)	2-30"(762mm)	ABBX-10RT-	3350	3518
		144" x 48"(3658mm x 1219mm)	1-30"(762mm)(X) & 4-10"(254mm)(L)	ABBX-12RT-	3323	3489
		168" x 60"(4267mm x 1524mm)	1-30"(762mm)(X) & 4-10"(254mm)(L)	ABBX-14RT-	3323	3489
		192" x 60"(4877mm x 1524mm)	2-30"(762mm)(X) & 4-10"(254mm)(L)	ABBX-16RT-	4998	5248
		216" x 60"(5486mm x 1524mm)	2-30"(762mm)(X) & 4-10"(254mm)(L)	ABBX-18RT-	4998	5248
		240" x 60"(6096mm x 1524mm)	2-30"(762mm)(X) & 4-10"(254mm)(L)	ABBX-20RT-	4998	5248

- X-panel and L-panel style bases made of veneered panels with solid wood edge banding on ends and detail at bottom of base.
- Available in Anegre veneers and Agathis solids.
- Tops ordered separately, see pages 188-189.

**To Order, Specify:**

- Product number.  
–Specify base edge detail as **9th digit** in product number.
  - 1** Classic
  - 2** Modern
  - 4** Traditional
- Reveal finish color.
- Wood finish color (Anegre).

**Base Placement:**

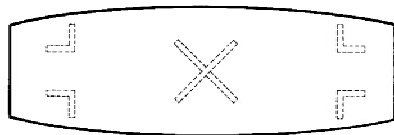

ABBX (quantity 1), ABBL (quantity 4)

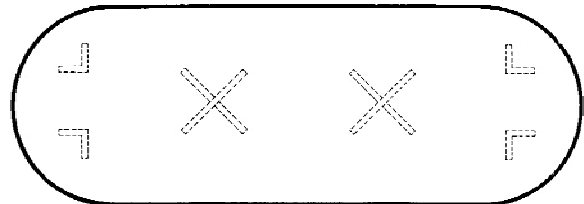

ABBX (quantity 2), ABBL (quantity 4)



## Varia Cylinder Table Bases by SMED

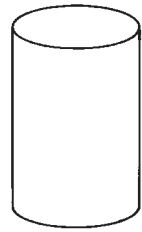

ABBD

Top Shape	Top Size	Base Quantity and Size	Number	Wood Finish Group 3	Wood Finish Group 4
Round	36"(914mm)	1-18"(457mm)	ABBD-36RO	\$1181	\$1240
	42"(1067mm)	1-18"(457mm)	ABBD-42RO	1181	1240
	48"(1219mm)	1-24"(610mm)	ABBD-48RO	1562	1640
	60"(1524mm)	1-24"(610mm)	ABBD-60RO	1562	1640
Rectangle	72" x 42"(1829mm x 1067mm)	2-18"(457mm)	ABBD-72RE	\$2374	\$2493
	96" x 48"(2438mm x 1219mm)	2-18"(457mm)	ABBD-96RE	2374	2493
	120" x 48"(3048mm x 1219mm)	2-18"(457mm)	ABBD-10RE	2374	2493
	144" x 48"(3658mm x 1219mm)	3-18"(457mm)	ABBD-12RE	3368	3536
	168" x 60"(4267mm x 1524mm)	3-24"(610mm)	ABBD-14RE	4596	4826
	192" x 60"(4877mm x 1524mm)	3-24"(610mm)	ABBD-16RE	4596	4826
	216" x 60"(5486mm x 1524mm)	3-24"(610mm)	ABBD-18RE	4596	4826
	240" x 60"(6096mm x 1524mm)	3-24"(610mm)	ABBD-20RE	4596	4826
	Boat	72" x 42"(1829mm x 1067mm)	2-18"(457mm)	ABBD-72BO	\$2374
96" x 48"(2438mm x 1219mm)	2-18"(457mm)	ABBD-96BO	2374	2493	
120" x 48"(3048mm x 1219mm)	2-18"(457mm)	ABBD-10BO	2374	2493	
144" x 48"(3658mm x 1219mm)	3-18"(457mm)	ABBD-12BO	3368	3536	
168" x 60"(4267mm x 1524mm)	3-24"(610mm)	ABBD-14BO	4596	4826	
192" x 60"(4877mm x 1524mm)	3-24"(610mm)	ABBD-16BO	4596	4826	
216" x 60"(5486mm x 1524mm)	3-24"(610mm)	ABBD-18BO	4596	4826	
240" x 60"(6096mm x 1524mm)	3-24"(610mm)	ABBD-20BO	4596	4826	
Racetrack	72" x 42"(1829mm x 1067mm)	2-18"(457mm)	ABBD-72RT	\$2374	\$2493
	96" x 48"(2438mm x 1219mm)	2-18"(457mm)	ABBD-96RT	2374	2493
	120" x 48"(3048mm x 1219mm)	2-18"(457mm)	ABBD-10RT	2374	2493
	144" x 48"(3658mm x 1219mm)	3-18"(457mm)	ABBD-12RT	3368	3536
	168" x 60"(4267mm x 1524mm)	3-24"(610mm)	ABBD-14RT	4596	4826
	192" x 60"(4877mm x 1524mm)	3-24"(610mm)	ABBD-16RT	4596	4826
	216" x 60"(5486mm x 1524mm)	3-24"(610mm)	ABBD-18RT	4596	4826
240" x 60"(6096mm x 1524mm)	3-24"(610mm)	ABBD-20RT	4596	4826	

- Cylinder base.
- Laminated plywood with face veneers.
- Each base requires 100 pounds of sand (to be provided by the customer).
- Available in Anegre veneer.
- Tops ordered separately, see pages 188-189.

**To Order, Specify:**

- 1) Product number.
- 2) Wood finish color (Anegre).

# Conference Table Wire Management/Electrical

	Utility Hatch	Outlets Per Hatch	Description	Number	Price
<b>Power Hatch — Retrofit Kits</b>	1	3	With 12'(3658mm) cord, Domestic	BECM-1-AD	\$ 503
	2	3	With 12'(3658mm) cord, Domestic	BECM-1-BD	1007
	1	6	With 12'(3658mm) cord, Domestic	BECM-1-CD	719
	2	6	With 12'(3658mm) cord, Domestic	BECM-1-DD	1546
	1	3	For Chicago	BECM-1-AC	525
	1	3	With outlet box for New York City	BECM-1-AN	539
	2	3	With outlet box for New York City	BECM-1-BN	1043
	1	6	With outlet box for New York City	BECM-1-CN	755
	2	6	With outlet box for New York City	BECM-1-DN	1583



BECM-AD  
BECM-CD  
BECM-BD  
BECM-DD



\_ x 3

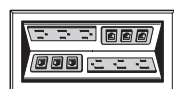

\_ x 6

**⚠ Note:** Furniture data parts field supplied.

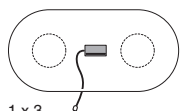

1 x 3

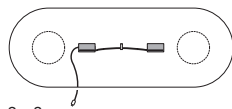

2 x 3

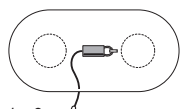

1 x 6

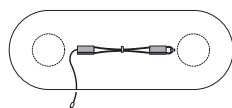

2 x 6

### Features

- Includes power hatch, cord and template.
- Includes telecommunication opening (1.38"(35mm) x 2.71"(69mm)) with blank cover. Opening accommodates modular furniture telecommunication outlets purchased separately.
- Adjustable mounting plate accommodates 1"(25mm) to 1 5/8"(41mm) thick tops.
- Power hatch extends 4"(102mm) below table top.
- Power hatch available in silver only with black cord.
- Housing extends 1/2"(13mm) past hole on all sides and sits on top of table surface.

### To Order, Specify:

- 1) Product number.  
(No finish specification required.)

### Specification Tips

- Available for field installation into factory or field-cut opening (template provided).
- Cord use should be reviewed by local authorities (electrical inspector) prior to ordering.
- 1 x 3 power hatch provides modular furniture information plate opening; 2 x 3 power hatch provides two information plate openings. Openings are 1.38(35mm) x 2.71(69mm) for snap-in communication plate.
- For power hatch placement other than shown here, please contact your Order Services representative.

# Conference Table Wire Management/Electrical

	Description	Number	Price
<b>Vertical Cable Chain</b>	31"(787mm) cable chain	BEVC-1	\$176

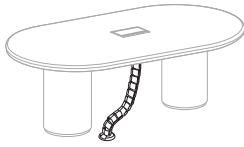

BEVC-1  
Class IF

**Features**

- Includes cable chain and attachment hardware (2 screws).
- Bottom cable chain link is weighted.
- Available in translucent material only.

**To Order, Specify:**

- 1) Product number.  
(No finish specification required.)

	Height	Depth	Width	Number	Price
<b>PVC Vertical Wire Manager</b>	26"(660mm)	1/2"(13mm)	1 1/8"(29mm)	CPVC-1	\$ 25



CPVC-1  
Class RA

**Features**

- For channeling cords neatly on outside of any table base.
- Standard in black finish only.

**To Order, Specify:**

- 1) Product number.  
(No finish specification required.)

<b>Wire Channel</b>	48"(1219mm)	L-WMT	\$ 37
---------------------	-------------	-------	-------



L-WMT  
Class RA

- Specify for use with desks, kneespace credenzas and desk extensions.
- Requires field installation.

**To Order, Specify:**

- 1) Product number.  
(No finish specification required.)

# Nottingham Tables

	Height	Depth	Width	Description	Number	Price
<b>Round Table</b>	30"(762mm)		42"(1067mm) Dia		OTTR-42	\$3168
	30"(762mm)		48"(1219mm) Dia.		OTTR-48	3896

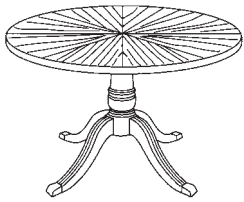

OTTR-42  
OTTR-48

- Walnut veneer inlaid in sunburst pattern with wood veneer edge.
- Four-legged pedestal base.
- Brass ferrules with adjustable leveling glides.
- Top and base shipped separate.

**To Order, Specify:**

- 1) Product number.
- 2) Wood finish color.

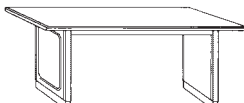
<b>Rectangle Table</b>	Height	Depth	Width	Description	Number	Price
	30"(762mm)	36"(914mm)	72"(1829mm)	Seats 6	OTTC-3672	\$1854
	30"(762mm)	44"(1118mm)	82"(2083mm)	Seats 8	OTTC-4482	2174
	30"(762mm)	42"(1067mm)	90"(2286mm)	Seats 8	OTTC-4290	3729
	30"(762mm)	48"(1219mm)	120"(3048mm)	Seats 10	OTTC-4820	3979
	30"(762mm)	48"(1219mm)	150"(3810mm)	Seats 12	OTTC-4850	4697

OTTC-3672  
OTTC-4482

- Grain runs length of table for OTTC-3672 and OTTC-4482.
- Grain runs width of table for OTTC-4290, OTTC-4820 and OTTC-4850.
- Two piece top for OTTC-4290, OTTC-4820 and OTTC-4850.
- Top thickness is 1 1/8"(29mm).
- Slab bases.
- With adjustable leveling glides.
- Tops and bases shipped separate.

**To Order, Specify:**

- 1) Product number.
- 2) Wood finish color.
- 3) Optional plastic laminate top (OTTC-3672 and OTTC-4482 only). 47-300 (matches Spencer wood finish).

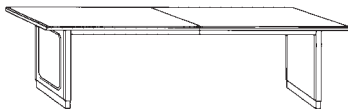

OTTC-4290  
OTTC-4820  
OTTC-4850

# Tripoli Tables by SMED

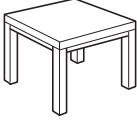
	Height	Depth	Width	Number	Wood Finish Group			
					1	2	3	4
 <p>LTTR-2424</p>	<b>End Table</b>							
	<b>Wood / Laminate Top</b>							
	16"(406mm)	24"(610mm)	24"(610mm)	LTTR-2424-	\$1037	\$1092	\$1147	\$1310
	<b>Metal Inlay</b>							
16"(406mm)	24"(610mm)	24"(610mm)	LTTR-2424-	\$1168	\$1223	\$1278	\$1441	
<ul style="list-style-type: none"> <li>• Wood veneer top, plastic laminate top or etched metal inlay.</li> <li>• Matching solid wood frame. Anegre uses Agathis.</li> </ul>				<b>To Order, Specify:</b> <ol style="list-style-type: none"> <li>1) Product number. –Specify edge detail as <b>9th digit</b> in product number.                             <ul style="list-style-type: none"> <li>1 Square edge</li> <li>2 Bevel edge</li> <li>3 Chamfer edge</li> <li>4 Radius edge</li> </ul> </li> <li>2) Wood finish color.</li> <li>3) Plastic laminate or etched metal finish color (if specified).</li> </ol>				

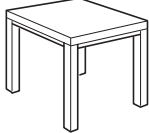
	Height	Depth	Width	Number	Wood Finish Group			
					1	2	3	4
 <p>LTTR-2230</p>	<b>Rectangular Table</b>							
	<b>Wood / Laminate Top</b>							
	21"(533mm)	22"(559mm)	30"(762mm)	LTTR-2230-	\$1141	\$1201	\$1261	\$1441
	<b>Metal Inlay</b>							
21"(533mm)	22"(559mm)	30"(762mm)	LTTR-2230-	\$1285	\$1345	\$1405	\$1585	
<ul style="list-style-type: none"> <li>• Wood veneer top, plastic laminate top, or etched metal inlay.</li> <li>• Matching solid wood frame. Anegre uses Agathis.</li> </ul>				<b>To Order, Specify:</b> <ol style="list-style-type: none"> <li>1) Product number. –Specify edge detail as <b>9th digit</b> in product number.                             <ul style="list-style-type: none"> <li>1 Square edge</li> <li>2 Bevel edge</li> <li>3 Chamfer edge</li> <li>4 Radius edge</li> </ul> </li> <li>2) Wood finish color.</li> <li>3) Plastic laminate or etched metal finish color (if specified).</li> </ol>				

# Tripoli Tables by SMED

	Height	Depth	Width	Number	Wood Finish Group			
					1	2	3	4
<b>Corner Table</b>	<b>Wood / Laminate Top</b>							
	21"(533mm)	30"(762mm)	30"(762mm)	LTTR-3030-	\$1186	\$1248	\$1310	\$1498
	<b>Metal Inlay</b>							
	21"(533mm)	30"(762mm)	30"(762mm)	LTTR-3030-	\$1336	\$1398	\$1460	\$1648

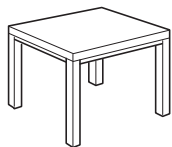

LTTR-3030

- Wood veneer top, plastic laminate top, or etched metal inlay.
- Matching solid wood frame. Anegre uses Agathis.

**To Order, Specify:**

- 1) Product number.  
–Specify edge detail as **9th digit** in product number.
  - 1** Square edge
  - 2** Bevel edge
  - 3** Chamfer edge
  - 4** Radius edge
- 2) Wood finish color.
- 3) Plastic laminate or etched metal finish color (if specified).

	Height	Depth	Width	Number	Wood Finish Group			
					1	2	3	4
<b>Rectangular Coffee Table</b>	<b>Wood / Laminate Top</b>							
	16"(406mm)	24"(610mm)	53"(1346mm)	LTTR-2453-	\$1304	\$1373	\$1442	\$1648
	<b>Metal Inlay</b>							
	16"(406mm)	24"(610mm)	53"(1346mm)	LTTR-2453-	\$1469	\$1538	\$1607	\$1813

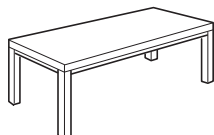

LTTR-2453

- Wood veneer top, plastic laminate top, or etched metal inlay.
- Matching solid wood frame. Anegre uses Agathis.

**To Order, Specify:**

- 1) Product number.  
–Specify edge detail as **9th digit** in product number.
  - 1** Square edge
  - 2** Bevel edge
  - 3** Chamfer edge
  - 4** Radius edge
- 2) Wood finish color.
- 3) Plastic laminate or etched metal finish color (if specified).

# Tripoli Tables by SMED

	Height	Depth	Width	Number	Wood Finish Group			
					1	2	3	4
<b>Coffee Table</b>	<b>Wood / Laminate Top</b>							
	16"(406mm)	42"(1067mm)	42"(1067mm)	LTTR-4242-	\$1216	\$1280	\$1344	\$1536
<b>Metal Inlay</b>								
	16"(406mm)	42"(1067mm)	42"(1067mm)	LTTR-4242-	\$1370	\$1434	\$1498	\$1690

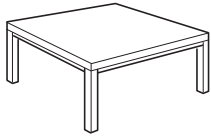

LTTR-4242

- Wood veneer top, plastic laminate top, or etched metal inlay.
- Matching solid wood frame. Anegre uses Agathis.

**To Order, Specify:**

- 1) Product number.  
–Specify edge detail as **9th digit** in product number.
  - 1** Square edge
  - 2** Bevel edge
  - 3** Chamfer edge
  - 4** Radius edge
- 2) Wood finish color.
- 3) Plastic laminate or etched metal finish color (if specified).

	Height	Depth	Width	Number	Wood Finish Group			
					1	2	3	4
<b>Drum Table</b>	<b>Wood / Laminate Top</b>							
	21"(533mm)	18"(457mm)		LTSB-1821	\$692	\$728	\$764	\$ 874
		24"(610mm)		LTSB-2421	797	839	881	1007
<b>Metal Inlay</b>								
	21"(533mm)	18"(457mm)		LTSB-1821	\$779	\$815	\$851	\$ 961
		24"(610mm)		LTSB-2421	898	940	982	1108

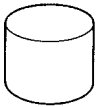

LTSB-1821  
LTSB-2421

- Wood veneer top or etched metal inlay.
- Wood veneer cylinder.
- Etched metal inlay is flush to the edge.
- Table is hollow with full, non-removable bottom.

**To Order, Specify:**

- 1) Product number.
- 2) Wood finish color.
- 3) Etched metal finish color (if specified).

# Galerie Collection 5800 Series Tables

Height	Depth	Width	Number	Wood Price	Glass Top Inset Price
16''(406mm)	18''(457mm)	18''(457mm)	5818-1816	\$1046	\$1203
22''(559mm)	18''(457mm)	18''(457mm)	5818-1822	1059	1218
16''(406mm)	26''(660mm)	26''(660mm)	5826-2616	1111	1278
22''(559mm)	26''(660mm)	26''(660mm)	5826-2622	1121	1289

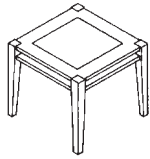

5818-1816

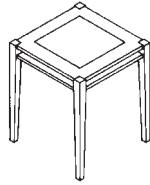

5818-1822

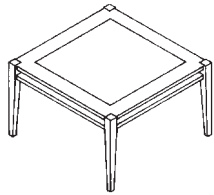

5826-2616

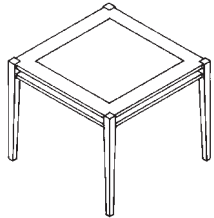

5826-2622

- Square tables feature a reverse-diamond veneer pattern inset.
- Glass inset option is 3/8''(10mm) thick frosted glass with a green tint.
- Standard with maple veneer insets and maple solids.
- Marble inset not available.

**To Order, Specify:**

- 1) Product number.
- 2) Wood finish color (Maple).

**Glass Option**

To specify glass top inset add **-G** suffix to the product number and refer to pricing listed above.



## Galerie Collection 5900 Series Tables

Height	Depth	Width	Number	Wood Price	Glass Top Inset Price
16''(406mm)	18''(457mm)	18''(457mm)	5918-1816	\$ 975	\$1121
22''(559mm)	18''(457mm)	18''(457mm)	5918-1822	987	1135
16''(406mm)	26''(660mm)	26''(660mm)	5926-2616	1067	1227
22''(559mm)	26''(660mm)	26''(660mm)	5926-2622	1079	1249

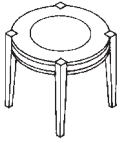

5918-1816

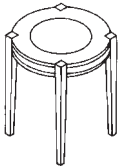

5918-1822

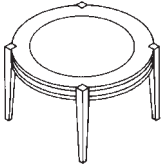

5926-2616

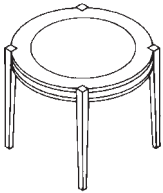

5926-2622

- Round tables feature a straight-grain veneer pattern inset.
- Glass inset option is 3/8''(10mm) thick frosted glass with a green tint.
- Standard with maple veneer insets and maple solids.
- Marble inset not available.

**To Order, Specify:**

- 1) Product number.
- 2) Wood finish color (Maple).

**Glass Option**

To specify glass top inset add **-G** suffix to the product number and refer to pricing listed above.

# Dendhur Group Tables

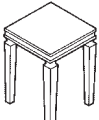
	Height	Depth	Width	Number	Wood Price	Special Top Inset PW
	22"(559mm)	16"(406mm)	16"(406mm)	6416-1616	\$1384	\$1522
	22"(559mm)	23 3/4"(603mm)	23 3/4"(603mm)	6423-2322	2208	2429
	15"(381mm)	37 1/4"(946mm)	37 1/4"(946mm)	6437-3715	2818	3100
	23"(584mm)	18"(457mm)	18"(457mm)	6418-1818	1384	1522
	23"(584mm)	22"(559mm)	22"(559mm)	6422-2223	2417	2659
	16"(406mm)	36"(914mm)	36"(914mm)	6436-3616	2916	3208

6416-1616

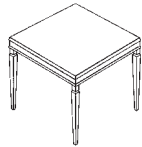

6423-2322

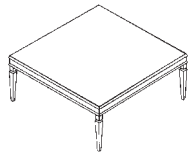

6437-3715

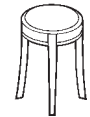

6418-1818



6422-2223

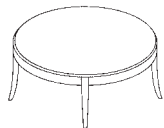

6436-3616

- Square tables feature apron marquetry of alternating ebonized veneer.
- Round tables feature top edge marquetry of alternating ebonized veneer.
- Reverse diamond standard top pattern on all tables.
- Available with maple veneers and maple solids.

**To Order, Specify:**

- 1) Product number.
- 2) Wood finish color (Maple).
- 3) Special top inset.

# Varia Leg Tables by SMED

Height	Depth	Width	Number	Wood Finish Group		Special Top Inset		
				3	4	Laminate	S1	S2
16"(406mm)	30"(762mm)	30"(762mm)	ABLF-3030-	\$1625	\$1706	\$1722	\$2779	\$3348
16"(406mm)	20"(508mm)	44"(1118mm)	ABLF-2044-	1687	1771	1788	2902	3526
20"(508mm)	20"(508mm)	20"(508mm)	ABLE-2020-	1378	1447	1461	1998	2301
22"(559mm)	18"(457mm)	26"(660mm)	ABLC-1826-	1432	1504	1518	2119	2463
22"(559mm)	30"(762mm)	30"(762mm)	ABLC-3030-	1769	1857	1875	2883	3450

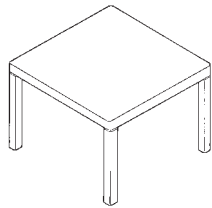

ABLC-3030

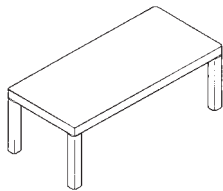

ABLF-2044

- Available with Anegre veneer and Agathis solids.

**To Order, Specify:**

- 1) Product number.  
 -Specify edge detail as **9th digit** in product number.
  - 1** Classic
  - 2** Modern
  - 4** Traditional
- 2) Wood finish color (Anegre).
- 3) Laminate or stone inset (if applicable).

# Varia Cube Tables by SMED

Height	Depth	Width	Number	Wood Finish Group		Special Top Inset		S1	S2
				3	4	Laminate			
16"(406mm)	30"(762mm)	30"(762mm)	ABUF-3030-	\$2314	\$2430	\$2595	\$3168	\$3594	
16"(406mm)	20"(508mm)	44"(1118mm)	ABUF-2044-	2358	2476	2639	3264	3717	
20"(508mm)	20"(508mm)	20"(508mm)	ABUE-2020-	1986	2085	2202	2444	2672	
22"(559mm)	18"(457mm)	26"(660mm)	ABUC-1826-	2150	2258	2366	2656	2913	
22"(559mm)	30"(762mm)	30"(762mm)	ABUC-3030-	2473	2597	2754	3327	3753	

- Available with Anegre veneer and Agathis solids.

### To Order, Specify:

- 1) Product number.  
–Specify edge detail as **9th digit** in product number.
 

<b>1</b>	Classic
<b>2</b>	Modern
<b>4</b>	Traditional
- 2) Reveal finish color.
- 3) Wood finish color (Anegre).
- 4) Laminate or stone inset (if applicable).

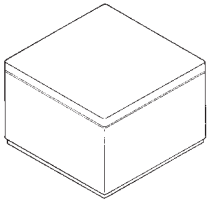

ABUC-3030

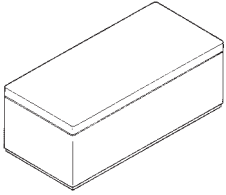

ABUF-2044

# Varia Drum Tables by SMED

	Height	Depth	Width	Number	Wood Finish Group		Special Top Inset		
					3	4	Laminate	S1	S2
	20"(508mm)	18"(457mm)	18"(457mm)	ABDE-18-	\$1605	\$1685	\$1788	\$2139	\$2406
	20"(508mm)	24"(610mm)	24"(610mm)	ABDE-24-	2005	2105	2236	2875	3311
	16"(406mm)	30"(762mm)	30"(762mm)	ABDF-30-	2166	2274	2460	3269	3821
	20"(508mm)	30"(762mm)	30"(762mm)	ABDE-30-	2351	2469	2645	3454	4006



ABDE-18-1N



ABDE-24-1N

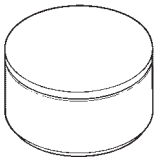

ABDF-30-1N

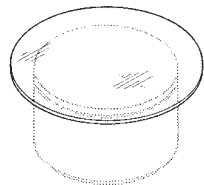

ABDE-30-1G  
(Glass top)

- Available with Anegre veneer and Agathis solids.
- Special top insets include laminate, wood or stone.
- Removable bottom panel.
- Weight filler recommended.
- Glass top has a clear finish.
- Glass top is 1/2"(13mm) thick.
- 30"(762mm) glass top for 18"(457mm) and 24"(610mm) diameter tables.
- 42"(1067mm) glass top for 30"(762mm) diameter table.

**To Order, Specify:**

- Product number.
  - Specify edge detail as **7th digit** in product number.
    - 1** Classic
    - 2** Modern
    - 4** Traditional
  - Specify glass top as **8th digit** in product number.
    - G** Glass, add \$542 list for 42" glass top, add \$343 list for 30" glass top.
    - N** No glass
- Wood finish color (Anegre).
- Laminate or stone inset (if applicable).

# Nottingham Tables

	Height	Depth	Width	Description	Number	Price
<b>End Table</b>	22"(559mm)	24"(610mm)	24"(610mm)		OTTO-2424	\$724

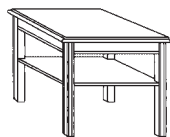

OTTO-2424

- Wood veneer top with solid wood edge.
- With stretcher shelf.
- Non-adjustable metal glides.

**To Order, Specify:**

- 1) Product number.
- 2) Wood finish color.

<b>Coffee Table</b>	16"(406mm)	19"(483mm)	46"(1168mm)		OTTO-1946	\$776
---------------------	------------	------------	-------------	--	-----------	-------



OTTO-1946

- Wood veneer top with solid wood edge.
- Non-adjustable metal glides.

**To Order, Specify:**

- 1) Product number.
- 2) Wood finish color.

## Casegoods/Tables Finish Matrix

Haworth Wood Finish Group	SMED Wood Finish Group	Executive Casegoods/Tables Finish Matrix	Sherbrooke	Orlando by SMED Casegoods/Tables	Tripoli by SMED Casegoods/Tables	PLACES Casegoods	Varia by SMED Casegoods/Tables	Nottingham Casegoods/Tables (High Gloss Top)	Entropy/Series K Profile by SMED	Dendhur and Galerie
		<b>Wood Finishes</b>								
I	1	<b>Oak</b>								
		Oak		VJ-W05	VJ-W05				VJ-W05	
II	2	<b>Cherry</b>								
		Amber		VD-W18	VD-W18	VC-CA1			VD-W18	
		American		VD-W23	VD-W23				VD-W23	
		Classic		VD-W20	VD-W20				VD-W20	
		Crown		VD-W24	VD-W24				VD-W24	
		Lager		VD-W11	VD-W11				VD-W11	
		Light		VD-W06	VD-W06				VD-W06	
		Medium		VD-W19	VD-W19	VC-U			VD-W19	
		Piazza		VD-W10	VD-W10				VD-W10	
		Stout		VD-W09	VD-W09				VD-W09	
I	2	<b>Maple</b>								
		Amber								M2-CDJ
		American								M2-A
		Chestnut								M2-79
		Classic								M2-83
		Cordovan								M2-CAJ
		Crown								M2-380
		Mahogany Satin								M2-CAA
		Medium Cherry								M2-CAD
		Natural		VG-W03	VG-W03	VP-N			VG-W03	M2-11
		Regent								M2-240
		Sand		VG-W17	VG-W17	VP-AD			VG-W17	M2-AD
		Sedgefield								M2-170
		Spencer								M2-300
		Washed		VG-W02	VG-W02				VG-W02	
	2	<b>Walnut</b>								
		Classic						YW-83		
		Cordovan		VR-W13	VR-W13			YW-CD	VR-W13	
		Dover						YW-480		
		Espresso		VR-W15	VR-W15				VR-W15	
		Mahogany Satin		VR-W21	VR-W21			YW-A	VR-W21	
		Naturally		VR-W12	VR-W12				VR-W12	
		Regent						YW-240		
		Sedgefield						YW-170		
		Spencer						YW-300		
	3	<b>Beech</b>								
		Beech		VT-W04	VT-W04				VT-W04	
	3	<b>Quarter-cut Anegre</b>								
		Amber					A2-W25			
		American					A2-W26			
		Chestnut					A2-W27			
		Classic					A2-W28			
		Mahogany Satin					A2-W29			
		Medium Cherry					A2-W30			

# Casegoods/Tables Finish Matrix

Haworth Wood Finish Group	SMED Wood Finish Group	Executive Casegoods/Tables Finish Matrix	Sherbrooke	Orlando by SMED Casegoods/Tables	Tripoli by SMED Casegoods/Tables	PLACES Casegoods	Varia by SMED Casegoods/Tables	Nottingham Casegoods/Tables (High Gloss Top)	Entropy/Series K Profile by SMED	Dendhur and Galeire
	4	<b>Pinched Anegre</b>								
		Cordovan		VU-W14	VU-W14		VU-W14		VU-W14	
		Espresso		VU-W16	VU-W16		VU-W16		VU-W16	
		Golden		VU-W08	VU-W08		VU-W08		VU-W08	
		Light		VU-W07	VU-W07		VU-W07		VU-W07	
I		<b>Double-cut</b>								
		Light Oak				VL-L				
		Mahogany Satin				VM-A				
		Medium Oak				VK-M				
II		<b>Anegre</b>								
		Lancaster-Light Cherry				VN-LC				
		Monterey-Medium Walnut				VN-MT				
		Vancouver-Dark Cherry				VN-VC				
		<b>Laminate</b>								
		Amber Cherry	H-AH	LL-AM	LL-AM					
		Graphite	H-3J							
		Maple	H-AE							
		Medium Cherry	H-AD	LL-AD	LL-AD					
		Natural Maple		LL-NT	LL-NT					
		Putty	H-AA							
		Spencer						47-300		



# Casegoods/Tables Finish Matrix

### Orlando Grid Accessory Trim Colors

TR-R	Beige
TR-K	Charcoal
TR-G	Gray Tone
TR-P	Platinum
TR-S	Sand
TR-E	Smoke
TR-T	Tan

### Grommet Finishes

	Black	Brass
Orlando	TR-K	—
Tripoli	TR-K	—
PLACES	TR-K	—
Varia	GR-BL	GR-PB

### Etched Metal Inlay Finish Colors

<b>Tripoli Buffet/Caddy/Presentation Boards</b>	
<b>Entropy Table Base</b>	
<b>Series K/Profile Table Tops</b>	
EB-LEB	Light Etched Brass
EB-MEB	Medium Etched Brass
EU-LEP	Light Etched Pewter
EU-MEP	Medium Etched Pewter
EU-NP	Natural Etched Pewter
EU-AP	Antique Etched Pewter
EU-SP	Slate Etched Pewter
<b>Note:</b> Etched metal inlay tops are sealed with polyurethane finish.	

### Varia Reveal Finishes

RV-BL	Black
RV-BR	Brass

### Sherbrooke Plastic Trim Colors

TR-J	Graphite
TR-AA	Putty
<b>Note:</b> Plastic trim colors refer to the drawer pulls, flexible grommets, and wire management channel.	

### Special Top Inset Finish Matrix

	Stone					Spex Laminates		Solid Color/Wood Grain Laminates							
	Black Granite	Blue Pearl Granite	Italian Verde Green	Rover Verdi Alpi	Rover Rosso Levanto	Grey Spex	White Spex	Beige	Charcoal	Medium Cherry	Maple	Putty	Sand	Stone	Smoke
Varia Reception	S2-BG	S2-BP	S2-GM	S1-RV	S1-RL	H-22	H-21	H-34	H-8J	H-AD	H-AE	H-AA	H-3N	H-AC	H-3E
Varia Conference/Occasional Tops	S2-BG	S2-BP	S2-GM	S1-RV	S1-RL	H-22	H-21	H-34	H-8J	H-AD	H-AE	H-AA	H-3N	H-AC	H-3E
Varia Drum Tables	S2-BG	S2-BP	S2-GM	S1-RV	S1-RL	H-22	H-21	H-34	H-8J	H-AD	H-AE	H-AA	H-3N	H-AC	H-3E

# Fabric/Color Legend

## Fabric Pattern Usage Matrix

Haworth casegoods upholstered products are restricted to fabric patterns that meet applicability standards for tailoring. A dot in the matrix indicates fabric acceptability on casegoods lines listed. Fabrics are listed alphabetically by grade.

Fabric part numbers shown can be used to order fabric only.

\*Select Essentiel fabrics available on Sherbrooke (Claret, Cloud, Feather Gray and Navy), see list below.

	Casegoods Line						
	Sherbrooke	Orlando by SMED	PLACES	Tripoli by SMED	Varia by SMED	Nottingham	
<b>Grade: Pattern</b>	<b>Part #</b>						
A: Essentiel	4320-1306	●*	●	●	●	●	●
A: Pinpoint	4320-0401		●	●	●	●	●
A: Taccata	4320-6601		●	●	●	●	
A: Tatami	1410-1325		●	●	●	●	
A: Tellure	4320-1315		●	●	●	●	●
B: Basketweave	1410-1000		●	●	●	●	●
B: Biscotti	4320-6701		●	●	●	●	
B: Jabberwocky Panel	1410-1320		●	●	●	●	
B: Kavalla	4320-8701		●	●	●	●	
B: Kendo	1410-1326		●	●	●	●	
B: Reel	1410-1330		●	●	●	●	
B: Spindrift	4320-1305		●	●	●	●	●
B: Tangram	1410-1327		●	●	●	●	
B: Verona	4320-8801		●	●	●	●	
B: Vines	1410-1331		●	●	●	●	
C: Flannel	1410-1003		●	●	●	●	●
C: Scarpa	1410-1323		●	●	●	●	
C: Silk Tweed	4320-1301		●	●	●	●	●

## Fabric/Color Legend

- Fabrics listed on pages 210-211 apply to select upholstered products.
- To obtain fabric samples contact your authorized Haworth dealer.

### Fabric Grade: A ESSENTIEL

- 100% Polyester
- FE-CW Aqua
  - FE-CA Blush
  - FE-A7 Camel
  - FE-CC Claret\*
  - FE-AW Cloud\*
  - FE-A2 Dove
  - FE-AT Feather Gray\*
  - FE-A1 Fog
  - FE-DC Haze
  - FE-AY Iron
  - FE-DD Juniper
  - FE-C9 Limestone
  - FE-A4 Mushroom
  - FE-C1 Navy\*
  - FE-A5 Pebble
  - FE-C8 Quartz
  - FE-DA Sandstone
  - FE-CX Sky
  - FE-C6 Slate
  - FE-CT Spruce
  - FE-AX Steel
  - FE-C7 Zinc

### Fabric Grade: A PINPOINT

- 100% Polyester
- L-LD Azure
  - L-CC Blue Racer
  - L-LH Blush
  - L-CH Chamois
  - L-AF Claret
  - L-LE Delft
  - L-CF Divot
  - L-LP Dove
  - L-CE Field Mouse
  - L-CD Myo
  - L-CA Ore
  - L-LC Teal Patina
  - L-CJ Silver Moon

### Fabric Grade: A TACCATA

- 100% Polyester
- FL-AK Alpaca
  - FL-AD Confederate
  - FL-AH Dill
  - FL-AE Gherkin
  - FL-AP Harmonic
  - FL-AM Mercury
  - FL-AA Montego
  - FL-AF Morning Glory
  - FL-AR Opus
  - FL-AJ Sepia
  - FL-AL Smokewood
  - FL-AN Stone Mountain
  - FL-AT Timbre

### Fabric Grade: A TATAMI

- 100% Polyester
- W5-1 Agave
  - W5-2 Coir
  - W5-3 Geta
  - W5-4 Hemp
  - W5-5 Jute
  - W5-6 Kayar
  - W5-7 Kobe
  - W5-8 Saffron
  - W5-9 Sapporo
  - W5-10 Sisal
  - W5-12 Tabi
  - W5-11 Tesori

### Fabric Grade: A TELLURE

- 100% Polyester
- 3A-18 Black
  - 3A-29 Brick
  - 3A-20 Burgundy
  - 3A-11 Cactus
  - 3A-14 Copperwood
  - 3A-28 Dynamo
  - 3A-22 Galaxy
  - 3A-09 Gray
  - 3A-10 Green Moss
  - 3A-21 Imperial
  - 3A-23 Jodhpurs
  - 3A-16 Lake
  - 3A-25 Napa
  - 3A-19 Navy
  - 3A-06 Nickel
  - 3A-04 Plum
  - 3A-17 Prussian
  - 3A-02 Salmon
  - 3A-15 Sandstone
  - 3A-24 Sheik
  - 3A-27 Sweet Pea
  - 3A-05 Teal
  - 3A-26 Zen

### Fabric Grade: B BASKETWEAVE

- 100% Recycled Polyester
- F-6K Baby Blue
  - F-7M Birch
  - F-6X Bluegrass
  - F-7J Buff
  - F-AL Feather Blue
  - F-AJ Feather Gray
  - F-6J French Blue
  - F-2E Ivory
  - F-6Y Lavender
  - F-EA Natural
  - F-ED Orchid
  - F-EC Oyster
  - F-AF Parchment
  - F-AH Soft Lavender
  - F-JX Sterling
  - F-EH Verdigris

# Fabric/Color Legend

**Fabric Grade: B**
**BISCOTTI**
**60% Polyester, 40% Olefin**

FN-AJ Atlantis  
 FN-AE Copper  
 FN-AW Curry  
 FN-AT Fig  
 FN-AL Fresco  
 FN-AX Icing  
 FN-AR Macaroon  
 FN-AF Maize  
 FN-AG Opal Gray  
 FN-AD Pesto  
 FN-AC Phoenician  
 FN-AH Sea Spray  
 FN-AA Shark  
 FN-AN Silver Ash  
 FN-AP Torte  
 FN-AM Wafer

**Fabric Grade: B**
**JABBERWOCKY PANEL**
**100% Polyester**

SY-AE Borogrove  
 SY-AK Claws & Jaws  
 SY-AD Gallumphing  
 SY-AJ Manxome  
 SY-AF Momerath  
 SY-AH Tulgy Woods  
 SY-AC Uffish Thought  
 SY-AA Wabe

**Fabric Grade: B**
**KAVALLA**
**81% Polyester, 19% Olefin**

SE-AP Bella  
 SE-AA Carrara  
 SE-AL Grotto  
 SE-AN Kava  
 SE-AE Latte  
 SE-AJ Nuvolo  
 SE-AM Tempestra  
 SE-AC Travertine  
 SE-AK Trisco

**Fabric Grade: B**
**KENDO**
**100% Polyester**

W6-1 Aikido  
 W6-2 Bushido  
 W6-3 Ghazi  
 W6-4 Greze  
 W6-5 Judo  
 W6-6 Jujitsu  
 W6-7 Kansu  
 W6-8 Kata  
 W6-9 Kwon-do  
 W6-10 Saber  
 W6-11 Tai-chi  
 W6-12 Tussle

**Fabric Grade: B**
**REEL**
**100% Polyester**

FU-11 Adobe  
 FU-9 Cement  
 FU-3 Chinking  
 FU-4 Float  
 FU-10 Grout  
 FU-8 Hawk  
 FU-5 Key  
 FU-13 Parget  
 FU-7 Pebble Dash  
 FU-2 Render  
 FU-12 Rock Dash  
 FU-6 Roughcast  
 FU-1 Stucco

**Fabric Grade: B**
**SPINDRIFT**
**100% Polyester**

SL-CL Azure  
 SL-CA Clear Pink  
 SL-CF Cloud Gray  
 SL-FC Deep Verdigris  
 SL-FR Froth  
 SL-CH Griege  
 SL-FK Hunter  
 SL-CC Light Blue  
 SL-AC Menthe  
 SL-CD Pale Lilac  
 SL-FJ Plum  
 SL-AX Stone  
 SL-AA Straw  
 SL-FN Tumbleweed  
 SL-FF Wine  
 SL-CE Wintergreen

**Fabric Grade: B**
**TANGRAM**
**100% Polyester**

W7-1 Bamboozle  
 W7-2 Conundrum  
 W7-3 Cryptic  
 W7-4 Enigma  
 W7-5 Jenga  
 W7-6 Jig  
 W7-7 Koan  
 W7-8 Labyrinth  
 W7-9 Mah Jongg  
 W7-10 Maze  
 W7-11 Mizmase  
 W7-12 Rebus

**Fabric Grade: B**
**VERONA**
**86% Polyester,**
**14% Olefin**

SF-AL Argento  
 SF-AP Ciao  
 SF-AM Ferra  
 SF-AJ Gesso  
 SF-AA Lido  
 SF-AR Luna  
 SF-AC Mezzo  
 SF-AN Piazza  
 SF-AW Puzzo  
 SF-AT Roma  
 SF-AK Strada  
 SF-AE Tosta

**Fabric Grade: B**
**VINES**
**100% Recycled Polyester**

FX-10 Arbor  
 FX-8 Clematis  
 FX-11 Dewberry  
 FX-12 Grape  
 FX-2 Greenbrier  
 FX-5 Honeysuckle  
 FX-1 Hop  
 FX-7 Jasmine  
 FX-3 Liana  
 FX-9 Pergola  
 FX-6 Trumpet Creeper  
 FX-4 Wey

**Fabric Grade: C**
**FLANNEL**
**65% Wool,**
**35% Polyester**

FF-NA Grey-Blue  
 FF-NP Lavender  
 FF-NC Mint  
 FF-NL Oatmeal  
 FF-ND Old Rose  
 FF-EAP Peppercorn  
 FF-EAM Sesame

**Fabric Grade: C**
**SCARPA**
**100% Polyester**

S5-AC Ceramic  
 S5-AE Losa  
 S5-AK Mattonella  
 S5-AJ Pavestone  
 S5-AH Pottery  
 S5-AA Slip  
 S5-AF Tegolo  
 S5-AD Tessalate

**Fabric Grade: C**
**SILK TWEED**
**96% Polyester, 4% Silk**

FS-MH Ashen  
 FS-MY Canvas  
 FS-MC Delft  
 FS-MT Fawn  
 FS-MF Flax  
 FS-MV Gryphon  
 FS-MA Ivy  
 FS-MM Meadow  
 FS-ML Oatmeal  
 FS-MN Pale Juniper  
 FS-MJ Pepper  
 FS-MD Plum

## Customer's Own Material General Information

Haworth is pleased to offer the option of customized materials, other than those listed in the Haworth price lists, for specification on our furniture products. Please note the following C.O.M. procedures, requirements, policies, lead times and warranties to help us accommodate your requests:

### To confirm approval of or request new approval for C.O.M.'s:

First, call the **Haworth Order Services Inquiry Center** to find out if the C.O.M. you have selected has already been tested and approved for use on the product.

If yes, ask for the **C.O.M.** code from Order Services which is to be included on all purchase orders for products using that C.O.M. Also, to facilitate receiving materials, Haworth dealers and specifiers are asked to include this information on the packing lists when sending the C.O.M. to Haworth.

If no, please provide the following materials which can be obtained from a Haworth dealer or Haworth Market Manager:

- A completed C.O.M. data sheet
- An appropriately sized sample of the C.O.M. as outlined in the Testing for Manufacturing Feasibility section, tagged with:
  1. Your Order Services Coordinator's name
  2. Haworth dealer or specifier
  3. A note indicating that material is "for testing"

Please submit the C.O.M. data sheet and the C.O.M. testing sample for processing as follows:

Haworth, Inc.  
One Haworth Center  
Holland, MI 49423-9576  
Attn: COM DEPT. 1-28A

Upon completion of the C.O.M. testing, Haworth Order Services will notify the Haworth Dealer of the test results. If the C.O.M. has been approved, it will be assigned a C.O.M. code to be used in completing all applicable purchase orders.

### To order and ship C.O.M.'s for production:

To facilitate the processing of your approved C.O.M. requests, please be sure to include the following information on the product purchase orders:

- C.O.M. code
- C.O.M. supplier, pattern name, and color name/number
- Contact person for ordering the C.O.M. for manufacturing
  - Haworth Order Services Coordinator, or
  - Customer name

To facilitate the receiving of your approved C.O.M. for production, please be sure to include the following information on the shipment's packing list:

- Haworth Dealer name
- Purchase order number as submitted to Haworth, Inc.
- Supplier name
- Fabric pattern and color name
- Yardage amount shipped
- C.O.M. code

Please send C.O.M.'s for production to the following address:

For Orlando, Tripoli, Vancouver, Varia and Conferences Tables products:

SMED International  
Attn: Receiving  
10 SMED Lane SE  
Calgary Alberta  
CANADA T2C 4T5

For PLACES products:

HAWORTH, Inc.  
Attn: Receiving  
One Haworth Center  
Holland, MI 49423-9576

### C.O.M. Yardage Requirements for Manufacturing:

Please reference the C.O.M. yardage on the product page to determine the amount of material required to manufacture the products as specified on the corresponding Haworth purchase order. All material will be quality-inspected for flaws and shortages prior to production. Order Services will promptly notify customers of any defects or shortages, and product ship dates will be scheduled based on availability of all C.O.M. for production.

### C.O.M. Testing for Manufacturing Feasibility:

Please contact the Haworth Order Services Inquiry Center to obtain previous test result information. If testing of a specific material has been completed, re-testing is not necessary unless the size of the intended product application is larger than the width of the fabric, or the direction has changed from what was originally approved.

### Material Testing Requirements

Fabric	2 yards
-Components	Two 1 1/2" (38mm) x 3 1/2" (89mm) sample chips
High-Pressure Laminate	One 2" (51mm) x 2" (51mm) minimum sample chip
Wood Finish Match	

*Please note that the cost of the C.O.M. sample and testing fees are the customer's responsibility.*

### Material Testing Lead Times

Systems Fabric (components)	Five business days
High-Pressure Laminate	Two to three business days
Wood Finish Match Formulation	Ten business days

### Pricing:

All products specified with a C.O.M. fabric will be billed at fabric grade "A" plus the cost of the fabric. As a service Haworth will order production C.O.M., in which case the cost of the material plus four percent to cover shipping, handling and administration costs will be added to the order.

Laminate: All products specified with the customer's own laminate will be billed at the listed price plus a surcharge of **\$45** per item. Haworth reserves the right to increase the surcharge depending upon the laminate cost from our supplier. Please contact your Order Services Coordinator with any questions.

Wood Finishes: Custom wood finishes require an up-front **\$200** finish formulation fee. Product using custom wood finishes will be billed at an upcharge of 6% based on the list price of each custom wood finish product.

### C.O.M. Product Lead Times

Standard product lead times will apply to products specified with a C.O.M. from the time of scheduling. Haworth cannot schedule production and ship dates until all C.O.M. has arrived and is properly received. Customers who procure their own materials can help to keep projects moving by making sure all shipments are properly tagged and shipped to the proper location.

### C.O.M. Terms and Conditions

- Purchase orders cannot be accepted or entered unless manufacturing feasibility testing is complete with positive results. Panels and RACE pads require a flame test for manufacturing feasibility.
- Approval number and C.O.M. code are to be clearly indicated on the purchase order.
- Responsibility of who is to order the C.O.M. for production is to be clearly indicated on the purchase order.
- Customers will be billed for C.O.M.'s, even if the order is canceled.
- Haworth reserves the right to reject a C.O.M. if the quality of the C.O.M. is not satisfactory for the product. In such an event, Haworth Order Services will promptly notify customer with an explanation of the problem.

If Haworth agrees to use a C.O.M., the following limited warranty applies:

1. Haworth shall have no responsibility for the condition, quality, value, performance, physical properties, or any other aspect of the C.O.M.
2. Haworth shall have no liability for any damages, injuries, or losses to the customer or to any third party that shall be caused by any C.O.M., and the customer shall hold Haworth harmless for all such liability.
3. Haworth assumes no responsibility for the overall appearance, flammability, normal durability, colorfastness or any other quality of the C.O.M. after its application on a Haworth product beyond normal quality standards.

For complete C.O.M. warranty information, please refer to the Terms of Sale.

## Customer's Own Material (COM) Data Sheet

(Use 1 sheet per Formulation Request)

<b>PLEASE FILL FORM OUT COMPLETELY:</b>	
DATE:	HAWORTH DEALER/SPECIFIER/DEALER #:
CUSTOMER SERVICE COORDINATOR:	CITY/ STATE:
HAWORTH MARKET MANAGER:	CONTACT NAME:
DIVISION:	PHONE: <span style="float:right">FAX:</span>
CLIENT AND/OR PROJECT NUMBER:	CLIENT LOCATIONS:

### Material Information

1. MATERIAL SUPPLIER:	2. MATERIAL PATTERN/NAME AND NUMBER:
3. MATERIAL COLOR AND/OR NUMBER:	4. USABLE WIDTH IN INCHES (IF FABRIC):

**5. COM TO BE USED ON THE FOLLOWING:**

SEATING: (every color must be individually tested on all seating lines) Catalog Product Number:

<input type="checkbox"/> Flipper Doors	<input type="checkbox"/> PLACES	<input type="checkbox"/> UniGroup	<input type="checkbox"/> PREMISE (must also go through Specials)
<input type="checkbox"/> Screens	<input type="checkbox"/> RACE	<input type="checkbox"/> if Tackable	<input type="checkbox"/> Wainscot
<input type="checkbox"/> Panels*	<input type="checkbox"/> PLACES*	<input type="checkbox"/> UniGroup*	<input type="checkbox"/> PREMISE Panel, Stackable, Enhanced*
<input type="checkbox"/> Pads**	<input type="checkbox"/> RACE**	<input type="checkbox"/> Castelli 3D	<input type="checkbox"/> Crossings (must also go through Specials)
<input type="checkbox"/> Tackboards	<input type="checkbox"/> PLACES	<input type="checkbox"/> PREMISE	
<input type="checkbox"/> Tackboards	<input type="checkbox"/> if	<input type="checkbox"/> Orlando	<input type="checkbox"/> Vancouver
<input type="checkbox"/> Tackboards	<input type="checkbox"/> Nottingham	<input type="checkbox"/> Tripoli	<input type="checkbox"/> Varia
<input type="checkbox"/> Laminate	<input type="checkbox"/> Standard Worksurface	<input type="checkbox"/> Post Form	Catalog Product Number:
<input type="checkbox"/> Custom Color Paint	Sample must be enclosed		Catalog Product Number:
<input type="checkbox"/> Peds/Files/Bookcases	<input type="checkbox"/> PLACES	<input type="checkbox"/> UniGroup	<input type="checkbox"/> PREMISE

\*MUST BE UL LISTED: Panel Fabric not previously UL listed and approved for use on HAWORTH panels must be tested.

\*\*MUST BE FLAME TESTED: RACE Pads not previously FLAME listed and approved for use on RACE pads must be tested.

<p><b>6. DIRECTION FABRIC IS TO BE APPLIED (IF ANY):</b> I.E. Certain color, stripe, or yarn is to run vertically or horizontally</p> <p>MUST SPECIFY:</p>	<p>(DIAGRAM)</p>
--	------------------

**7. FOR CHAIRS:** Attach 12" x 12" labeled memo swatch, indicate application direction (see #6) along with Cal 117 documentation:

**8. HAWORTH REMOTE MANUFACTURING COMPANIES CANNOT STORE UNUSED COM FABRIC.**  
Fabric will be returned COLLECT IF REQUESTED BY CUSTOMER, AND IF SURPLUS IS GREATER THAN 10 YARDS.  
PLEASE NOTE ON PURCHASE ORDER.

<p><b>ADDITIONAL NOTES:</b></p> <ul style="list-style-type: none"> <li>· A fabric sent in for testing must be properly marked with the dealer's name, purchase order number, fabric name and quantity. Packing list must be attached to the <u>outside</u> of roll for proper identification.</li> <li>· Unbacked fabric is not advised and every color must be individually tested on <b>All Seating Products.</b></li> <li>· Fabric requirements based on 54" widths.</li> </ul>	<p><b>Return completed form to the COM Department:</b></p> <p><b>Haworth, Inc.</b>  <b>One Haworth Center</b>  <b>Attention: COM Department 1-28A</b>  <b>Holland, MI 49423-9576</b></p>
--	--



## Custom Finish Formulation Data Sheet

(Use 1 sheet per Formulation Request)

**PLEASE FILL FORM OUT COMPLETELY:**

DATE:	HAWORTH DEALER/SPECIFIER:
CUSTOMER SERVICE COORDINATOR:	CITY/STATE:
HAWORTH MARKET MANAGER:	CONTACT NAME:
DIVISION:	PHONE:
CLIENT AND/OR PROJECT NAME:	P.O. #

**\*There is a \$200.00 formulation fee for each match requested. Please send a P.O. to cover the cost along with this form to process your match.**

**INFORMATION REQUIRED COMPLETE**

ADDRESS SAMPLE TO BE SENT:

CONTACT NAME: \_\_\_\_\_

DEALER NAME: \_\_\_\_\_

ADDRESS: \_\_\_\_\_

**PLEASE CHECK:** Is this request to match existing product?

YES

NO

TYPE OF FINISH:  OPEN PORE  OTHER

SAMPLE MANUFACTURER NAME: \_\_\_\_\_

FINISH NAME/COLOR: \_\_\_\_\_

SPECIFY VENEER FOR FINISH TO BE APPLIED TO: \_\_\_\_\_

NOTE: CERTAIN VENEERS NOT AVAILABLE ON ALL PRODUCTS, REFER TO PRICE LIST CATALOG.

**CATALOG PRODUCT NAME/NUMBER MUST BE NOTED:**

SYSTEMS: \_\_\_\_\_ PRODUCT#: \_\_\_\_\_

CASEGOODS: \_\_\_\_\_ PRODUCT#: \_\_\_\_\_

CONFERENCE TABLE: \_\_\_\_\_ PRODUCT#: \_\_\_\_\_

OCCASIONAL TABLE: \_\_\_\_\_ PRODUCT#: \_\_\_\_\_

SEATING: \_\_\_\_\_ PRODUCT#: \_\_\_\_\_

OTHER: \_\_\_\_\_ PRODUCT#: \_\_\_\_\_

TWO (2) 3" X 5" SAMPLES WILL BE PROVIDED FOR APPROVAL

**Material Requirements For Finish Match:**

One (1) sample chip, no smaller than 2" x 2" is required for each custom match.

GENERAL: Finish match formulation takes 2 to 4 weeks.  
All 3" x 5" samples will be sent mail unless federal express # is given:

**Return completed form to the COM Department:**

Haworth, Inc.  
One Haworth Center  
Attention: COM Department 1-28A  
Holland, MI 49423-9576



# U.S.A. Terms of Sale

Haworth is defined as Haworth Inc. (U.S.A.).

## Ordering Information

HAWORTH sells its products on the terms set forth in these standard terms of sale:

Two types of orders can be placed verbally: standard product orders under \$4000 list and all RUSH orders. ALL OTHER ORDERS MUST BE SUBMITTED IN WRITING OR ELECTRONICALLY (E.O.P.) AS REPRESENTED BY A VALID PURCHASE ORDER, WHICH INCLUDES TOTAL LIST AND NET DOLLARS.

An order is not binding upon HAWORTH until HAWORTH issues an order acknowledgment, which will include price information and an anticipated shipping date.

## Order Changes/Cancellations

For Specials, Customer's Own Material (C.O.M.), finish matches, custom colors, custom products and RUSH orders, no changes or cancellations are allowed. All other products require approval for changes or cancellations made fewer than four weeks before the ship-date; a minimum fee of 15% of net will apply. Ship-to addresses changed within ten (10) business days of shipment may incur fees to cover administrative costs due to re-labeling of product. ALL CHANGES MUST BE IN WRITING, REGARDLESS OF THE (DOLLAR) VALUE. CHANGES ARE NOT BINDING UPON HAWORTH UNTIL HAWORTH ISSUES AN ACKNOWLEDGMENT OF THE CHANGE.

Order cancellations are complete annulments of orders. Order changes are the deletion of line items or a change in size, color, quantity, or ship-to address. There is no penalty for additions; however, any change may cause the order or portion affected to be rescheduled. Order changes involving additional product or increasing the net value must be accompanied by an amended net value purchase order.

## C.O.M. (Customer's Own Material)

A customer who requests a fabric, surface or finish material (C.O.M.) not standard to HAWORTH's line must first check with HAWORTH's Order Services department to determine if testing is required. HAWORTH will determine if the material is suitable for manufacturing processes, then establish a price for using the C.O.M. For a description of the procedure to submit C.O.M. samples, contact HAWORTH's Order Services department. For tests, see the C.O.M. section of the catalog, or call the HAWORTH Order Services Inquiry Center.

If HAWORTH agrees to use the C.O.M., (1) HAWORTH shall have no responsibility for the condition, quality, value, performance, physical properties, or any other aspect of the C.O.M.; and (2) HAWORTH shall have no liability for any damages, injuries, or losses to the customer or to any third party that shall be caused by any C.O.M., and the customer shall hold HAWORTH harmless for all such liability.

## Valid/Complete Purchase Order

The following information is required in order to process an order with HAWORTH:

## Customer Information

- Sold To:** Legal name, address (if HAWORTH is to bill the end user, provide end user purchase order made out to HAWORTH, Inc., or wholly owned HAWORTH subsidiary, or HAWORTH Inc., c/o Dealer) and phone number.
- Ship To:** Legal name and address.
- Purchase Order Number:** From the party HAWORTH will be billing.
- Authorized Signature:** All hardcopy purchase orders must be signed. Electronically transmitted purchase orders will be accepted without a signature if dealer billed.
- Contact Name and Phone Number:** Person HAWORTH should contact with any questions regarding the order.
- Shipping Contact:** Name and phone number of person to be contacted regarding shipping matters.
- Tagging Instructions**
- Price Agreement or National Sales Agreement Number**
- Product Total:** List/Net dollars.
- Installation and/or Design Fees** (if applicable).

## Product Information

- Quantity**
- Product Numbers**
- Colors** (includes all surface finishes).
- Specials:** Inquiry number if known.
- Customer's Own Material:** Order entry code (if known), manufacturer, pattern, color, name of company ordering the C.O.M.

## Order Confirmation

All orders will be acknowledged. Shipping information can be accessed via SourceLine on the web at [sourceline.haworth.com](http://sourceline.haworth.com); or from a touch-tone telephone by calling: within North America (800) 426-8562 or outside North America (616) 393-0195.

## Pricing Policies

### Terms of Payment

Terms of payment and credit limits will be established based on financial information. Standard payment terms on open credit are net thirty (30) days from invoice date. Advance payments or other payment security may be required by Haworth. Payment security may be required for International shipments.

The account balance must be at or below the credit limit and current at all times (no past-due balances). HAWORTH reserves the right to delay or cancel any shipment to a customer whose HAWORTH account balance is over the credit limit and/or past due.

## Past-Due Charges

Past-due balances will be increased by a maximum of 1.5% per month, or 18% annually, without forfeit of HAWORTH's right to immediate payment.

## Applicable Prices

List prices and discounts are subject to change without notice or approval. In the event of an adjustment to list prices, National Sales Agreement (NSA) customers will be notified in advance according to the terms of the NSA. Applicable prices are those in effect at the time of the RECEIPT of an order; HAWORTH reserves the right to use the published list prices effective at the time of shipment, if the requested shipping date is more than 120 days after the order receipt date.

The price of any product sold to Buyer by HAWORTH will be based upon the price list for the products as follows:

Destination	Price List
U.S.A. Canada	U.S.A. Canadian
U.K., S. Ireland	United Kingdom
International (excluding Canada, U.K., and S. Ireland)	U.S.A.

## Taxes

**U.S.A.:** HAWORTH list prices do not include any sales, use or similar taxes. The customer is responsible to remit directly to HAWORTH all such taxes.

A valid tax exemption certificate (if applicable) must be on file with HAWORTH prior to the product shipment; otherwise, sales tax will be due and payable.

**International** (other than Canada, U.K. and S. Ireland) . Prices listed in the U.S.A. Price List Catalogs do not include customs duty, value added or any other tax with respect to the sale, use, ownership, or value of any product or service provided by HAWORTH. Buyer is responsible for all such taxes.

## Services

List prices apply to products only. If, as a result of customer request, the HAWORTH dealer or HAWORTH subsidiary provides planning/design services, storage, special handling, set-up, or installation, the customer will be charged at the local HAWORTH dealer/subsidiary's standard rates.

# U.S.A. Terms of Sale

## Shipping and Delivery

### U.S.A.

All deliveries will be F.O.B. the HAWORTH distribution facility selected as the shipping point(s) by HAWORTH. Additionally, HAWORTH has the right to determine the carrier, method of shipment, and routing. Extra expense resulting from customer request for special carrier, shipping method, and/or routing will be billed to the customer.

Freight charges will be prepaid by HAWORTH. HAWORTH will pay the freight charges for normal surface transportation to destinations within the continental United States.

The customer assumes risk of loss upon HAWORTH'S delivery of the product to the carrier at the shipment point. HAWORTH reserves the right to ship products covered by a single order in more than one shipment.

### For International Orders

#### Overseas – International and non-continental U.S. INCOTERM-CIF (Cost of Goods, Insurance and Freight).

HAWORTH'S U.S.A. Price List Catalogs include ocean freight and insurance to the port of destination in the receiving country. HAWORTH has the right to determine the carrier, method of shipment and routing.

Haworth will contract with the insurer and provide minimal insurance coverage (CIF@110%) made payable to the buyer. Buyer is responsible to obtain greater insurance if so desired. Buyer assumes risk of loss or damage to the goods when the goods pass the ship's rail at the originating port of shipment. Proof of delivery is a free on board bill of lading.

Buyer will be responsible for all customs clearance and on-carriage from the receiving port in the destination country to the final destination.

#### Mexico. INCOTERM-DAF (Delivered at Frontier.)

HAWORTH'S U.S.A. Price List Catalogs include freight charges for normal surface transportation to a United States point of exportation within the 48 contiguous states. HAWORTH has the right to determine the carrier, method of shipment and routing.

Buyer will be responsible for all on-carriage and customs clearance from the point of exportation to the final destination. Buyer assumes risk of loss when goods are delivered to a United States point of exportation.

### Ship Dates and Delay

If HAWORTH cannot ship products as scheduled due to causes beyond its reasonable control (such as casualty, labor disputes, or accident; inability to obtain necessary labor, material or transportation; or changes requested by the customer), the ship date will be extended to compensate for the delay as determined by HAWORTH.

### Force Majeure

In the event that the performance of Buyer or HAWORTH or its participating dealer assignee(s) would be prevented, restricted, interfered with or rendered commercially impracticable by reason of Force Majeure, then upon the giving of notice to the other parties, the party affected by the Force Majeure shall be excused from performing hereunder until the Force Majeure no longer prevents, restricts, interferes with, or renders such performance commercially impracticable.

"Force Majeure" shall mean: Fire, explosion, breakdown of plant, epidemic, hailstorm, hurricane, tornado, cyclone, flood or power failure; War, revolution, civil commotion, acts of public enemies, blockade or embargo; Any law, order, proclamation, regulation, ordinance, demand or requirement of any government or any subdivision, authority, or representative of any such government; Labor difficulties, including without limitation, strikes, slowdowns, picketing or boycotts; and any other circumstances beyond the control of the party affected.

### Delivery Shortages and Damage

Product shortages and damage must be noted on delivery receipts at the time of delivery and reported to the carrier for correction.

Claims against HAWORTH for shortages, errors, or damage must be made within three (3) days of the date of delivery or the customer waives the right to make such a claim.

### Storage

HAWORTH may transfer product to storage at the customer's risk and expense if the customer is unable or unwilling to take delivery of product as scheduled. Upon such transfer to storage, the customer assumes risk of loss. HAWORTH will invoice the customer on a monthly basis for storage fees and the customer will make payments in accordance with HAWORTH's standard payment terms.

### Use and Installation of Products

HAWORTH recommends that its products be installed by certified installers according to HAWORTH's written installation procedures. The customer agrees to use HAWORTH products properly; not to remove or alter safety devices, warnings, or operation instructions placed on products by HAWORTH, and to instruct employees as to the proper care and use of the products according to printed instructions. Certified installers can be contracted through a HAWORTH dealer or affiliate on a separately negotiated basis.

### Return Authorization

The customer must request a return authorization through the HAWORTH Order Services department within ninety (90) days of product receipt to return unused product. If HAWORTH agrees to repurchase the product, the customer must return it freight prepaid to HAWORTH, F.O.B. the original shipping point

(for returns from International destinations, must be returned freight prepaid to HAWORTH, D.D.P. the original shipping point) or as otherwise instructed by HAWORTH Order Services. If product is returned without a Return Authorization HAWORTH will notify the customer of the unauthorized return and the customer must provide instructions within one (1) week on disposal (i.e., return to dealer at dealer expense, or HAWORTH dispose of product with no credit offered). Return authorization expires sixty (60) days after date of issue. The customer must promptly provide a purchase order or other acceptance of fees/credit reduction as required.

### Service

Service requests for design, installation, relocation, storage, etc. are handled by the local HAWORTH dealer. Contact the local HAWORTH dealer, affiliate or area sales office for more details.



# International Terms of Sale

Haworth is defined as Haworth Inc. (U.S.A.).

## Ordering Information

HAWORTH sells its products on the terms set forth in these standard terms of sale:

Two types of orders can be placed verbally: standard product orders under \$4000 list and all RUSH orders. ALL OTHER ORDERS MUST BE SUBMITTED IN WRITING OR ELECTRONICALLY (E.O.P.) AS REPRESENTED BY A VALID PURCHASE ORDER, WHICH INCLUDES TOTAL LIST AND NET DOLLARS.

An order is not binding upon HAWORTH until HAWORTH issues an order acknowledgment, which will include price information and an anticipated shipping date.

## Order Changes/Cancellations

For Specials, Customer's Own Material (C.O.M.), finish matches, custom colors, custom products and RUSH orders, no changes or cancellations are allowed. All other products require approval for changes or cancellations made fewer than four weeks before the ship-date; must be submitted to Customer Service for approval; and a minimum fee of 15% of net will apply. Ship-to addresses changed within ten (10) business days of shipment may incur fees to cover administrative costs due to re-labeling of product. ALL CHANGES MUST BE IN WRITING, REGARDLESS OF THE (DOLLAR) VALUE. CHANGES ARE NOT BINDING UPON HAWORTH UNTIL HAWORTH ISSUES AN ACKNOWLEDGMENT OF THE CHANGE.

Order cancellations are complete annulments of orders. Order changes are the deletion of line items or a change in size, color, quantity, or ship-to address. There is no penalty for additions; however, any change may cause the order or portion affected to be rescheduled. Order changes involving additional product or increasing the net value must be accompanied by an amended net value purchase order.

## C.O.M. (Customer's Own Material)

A customer who requests a fabric, surface or finish material (C.O.M.) not standard to HAWORTH's line must first check with HAWORTH's Order Services department to determine if testing is required. HAWORTH will determine if the material is suitable for manufacturing processes, then establish a price for using the C.O.M. For a description of the procedure to submit C.O.M. samples, contact HAWORTH's Order Services department. For tests, see the C.O.M. section of the catalog, or call the HAWORTH Order Services Inquiry Center.

If HAWORTH agrees to use the C.O.M., (1) HAWORTH shall have no responsibility for the condition, quality, value, performance, physical properties, or any other aspect of the C.O.M.; and (2) HAWORTH shall have no liability for any

damages, injuries, or losses to the customer or to any third party that shall be caused by any C.O.M., and the customer shall hold HAWORTH harmless for all such liability.

## Valid/Complete Purchase Order

The following information is required in order to process an order with HAWORTH:

## Customer Information

- Sold To:** Legal name, address (if HAWORTH is to bill the end user, provide end user purchase order made out to HAWORTH, Inc., or wholly owned HAWORTH subsidiary, or HAWORTH, Inc., c/o Dealer) and phone number.
- Ship To:** Legal name and address for where goods are to be delivered.
- Purchase Order Number:** From the party HAWORTH will be billing.
- Authorized Signature:** All hardcopy purchase orders must be signed. Electronically transmitted purchase orders will be accepted without a signature if dealer billed.
- Contact Name and Phone Number:** Person HAWORTH should contact with any questions regarding the order.
- Shipping Contact:** Name and phone number of person to be contacted regarding shipping matters.
- Tagging Instructions**
- Price Agreement or National Sales Agreement Number**
- Product Total:** List/Net dollars.
- Installation and/or Design Fees:** (if applicable).
- Freight, Duty and Tax:** Amounts are to be shown separate of the product totals, as available.
- International Order Profile**

## Product Information

- Quantity**
- Product Numbers**
- Colors** (includes all surface finishes).
- Specials:** Inquiry numbers if known.
- Customer's Own Material:** Order entry code (if known), manufacturer, pattern, color, name of company ordering the C.O.M.

## Order Confirmation

All orders will be acknowledged. Shipping information can be accessed via SourceLine on the web at [sourceline.haworth.com](http://sourceline.haworth.com); or from a touch-tone telephone by calling: within North America (800) 426-8562 or outside North America (616) 393-0195.

## Pricing Policies

### Terms of Payment

Terms of payment and credit limits will be established based on financial information. Standard payment terms on open credit are net thirty (30) days from invoice date. Advance payments or other payment security may be required by Haworth. Payment security may be required for International shipments.

The account balance must be at or below the credit limit and current at all times (no past due balances). HAWORTH reserves the right to delay or cancel any shipment to a customer whose HAWORTH account balance is over the credit limit and/or past due.

### Past-Due Charges

Past-due balances will be increased by a maximum of 1.5% per month, or 18% annually, without forfeit of HAWORTH's right to immediate payment.

### Applicable Prices

List prices and discounts are subject to change without notice or approval. In the event of an adjustment to list prices, National Sales Agreement (NSA) customers will be notified in advance according to the terms of the NSA. Applicable prices are those in effect at the time of the RECEIPT of an order; HAWORTH reserves the right to use the published list prices effective at the time of shipment, if the requested shipping date is more than 120 days after the order receipt date.

The price of any product sold to Buyer by HAWORTH will be based upon the price list for the products as follows:

Destination	Price List(s)
U.S.A. Canada	U.S.A. Canadian
U.K., S. Ireland	United Kingdom
International (excluding Canada, U.K., and S. Ireland)	U.S.A.

### Taxes

**International** (other than Canada, U.K. and S. Ireland). Prices listed in the U.S.A. Price List Catalogs do not include customs duty, value added or any other tax with respect to the sale, use, ownership, or value of any product or service provided by HAWORTH. Buyer is responsible for all such taxes.

### Services

List prices apply to products only. If, as a result of customer request, the HAWORTH dealer or HAWORTH subsidiary provides planning/design services, storage, special handling, set-up, or installation, the customer will be charged at the local HAWORTH dealer/subsidiary's standard rates.

# International Terms of Sale

---

## Shipping and Delivery

---

### For International Orders

HAWORTH reserves the right to ship products covered by a single order in more than one shipment.

### Overseas – International and non-continental U.S. INCOTERM-CIF (Cost of Goods, Insurance and Freight).

HAWORTH'S U.S.A. Price List Catalogs include ocean freight and insurance to the port of destination in the receiving country. HAWORTH has the right to determine the carrier, method of shipment and routing.

Haworth will contract with the insurer and provide minimal insurance coverage (CIF@110%) made payable to the buyer. Buyer is responsible to obtain greater insurance if so desired. Buyer assumes risk of loss or damage to the goods when the goods pass the ship's rail at the originating port of shipment. Proof of delivery is a free on board bill of lading.

Buyer will be responsible for all customs clearance and on-carriage from the receiving port in the destination country to the final destination.

### Mexico. INCOTERM-DAF (Delivered at Frontier.)

HAWORTH'S U.S.A. Price List Catalogs include freight charges for normal surface transportation to a United States point of exportation within the 48 contiguous states. HAWORTH has the right to determine the carrier, method of shipment and routing.

Buyer will be responsible for all on-carriage and customs clearance from the point of exportation to the final destination. Buyer assumes risk of loss when goods are delivered to a United States point of exportation.

Note: Under all shipping terms, extra expense resulting from buyer's request for expedited transportation, special carrier, packaging, shipping method and/or routing will be billed to buyer.

### Ship Dates and Delay

If HAWORTH cannot ship products as scheduled due to causes beyond its reasonable control (such as casualty, labor disputes, or accident; inability to obtain necessary labor, material or transportation; or changes requested by the customer), the ship date will be extended to compensate for the delay as determined by HAWORTH.

### Force Majeure

In the event that the performance of Buyer or HAWORTH or its participating dealer assignee(s) would be prevented, restricted, interfered with or rendered commercially impracticable by reason of Force Majeure, then

upon the giving of notice to the other parties, the party affected by the Force Majeure shall be excused from performing hereunder until the Force Majeure no longer prevents, restricts, interferes with, or renders such performance commercially impracticable.

"Force Majeure" shall mean: Fire, explosion, breakdown of plant, epidemic, hailstorm, hurricane, tornado, cyclone, flood or power failure; War, revolution, civil commotion, acts of public enemies, blockade or embargo; Any law, order, proclamation, regulation, ordinance, demand or requirement of any government or any subdivision, authority, or representative of any such government; Labor difficulties, including without limitation, strikes, slowdowns, picketing or boycotts; and any other circumstances beyond the control of the party affected.

### Delivery Shortages and Damage

Product shortages and damage must be noted on delivery receipts at the time of delivery and reported to the carrier for correction.

Claims against HAWORTH for shortages, errors, or damage must be made within three (3) days of the date of delivery or the customer waives the right to make such a claim.

### Storage

HAWORTH may transfer product to storage at the customer's risk and expense if the customer is unable or unwilling to take delivery of product as scheduled. Upon such transfer to storage, the customer assumes risk of loss. HAWORTH will invoice the customer on a monthly basis for storage fees and the customer will make payments in accordance with HAWORTH's standard payment terms.

### Use and Installation of Products

HAWORTH recommends that its products be installed by certified installers according to HAWORTH's written installation procedures. The customer agrees to use HAWORTH products properly; not to remove or alter safety devices, warnings, or operation instructions placed on products by HAWORTH, and to instruct employees as to the proper care and use of the products according to printed instructions. Certified installers can be contracted through a HAWORTH dealer or affiliate on a separately negotiated basis.

### Return Authorization

The customer must request a return authorization through the HAWORTH Customer Service Department within ninety (90) days of product receipt to return unused product. If HAWORTH agrees to repurchase the product, the customer must return it freight prepaid to HAWORTH, D.D.P. the original shipping point or as otherwise instructed by HAWORTH Order Services. If product is returned without a Return Authorization HAWORTH will notify the customer of the unauthorized return and the

customer must provide instructions within one (1) week on disposal (i.e., return to dealer at dealer expense or HAWORTH dispose of product with no credit offered). Return authorization expires sixty (60) days after date of issue. The customer must promptly provide a purchase order or other acceptance of fees/credit reduction as required.

### Service

Service requests for design, installation, relocation, storage, etc. are handled by the local HAWORTH dealer. Contact the local HAWORTH dealer, affiliate or area sales office for more details.

# Lifetime Product Warranty

## Haworth Lifetime Product Warranty

The following Haworth product warranty applies to products manufactured after January 1, 2002.

This warranty is given to the initial purchaser of new products purchased from Haworth, Inc. or Haworth, Ltd. (each is referred to as “Haworth”) or from an authorized Haworth dealer. The warranty is valid for as long as the product is owned or leased by the original buyer. The warranty, which is non-transferable, runs from the date of manufacture and covers defects in materials and craftsmanship found during normal usage of the products. If a product is defective and if written notice of the defect is given to Haworth within the Applicable Warranty Period, then Haworth at its option will either repair or replace the defective product with a comparable component or product.

Product(s)	Applicable Warranty Period
All Haworth products except those listed below	Lifetime
Electrical products and components, <b>if</b> high performance edge worktops, and European Collection products (other than European Collection Seating and Specials)	Ten (10) Years
Seating mechanisms (other than mechanisms in wood or wood framed chairs); auditorium products; and Castelli 3D products (other than catalog numbers 3DOS (overheads), 3DLF (files) and 3DPD and 3DPM (pedestal storage))	Ten (10) Years*
Wood or wood framed products, wood chairs and European Collection Seating including their mechanisms; fabrics rated A Heavy Duty under Association of Contract Textiles guidelines; user-adjustable worksurface mechanisms; thermofused laminates; <b>if</b> slow close mechanisms; and Jump Stuff products other than Boogie Board	Five (5) Years
Translucent plastic colorfastness	Three (3) Years
Fabrics rated <u>a</u> General Contract under the Association of Contract Textiles guidelines	Three (3) Years*
Non-standard Specials products (other than European Collection Specials); the Correspondent line of products; products constructed of Texon T-90 materials; Castelli 3D catalog numbers 3DOS (overheads), 3DLF (files) and 3DPD and 3DPM (pedestal storage); Soft Palm Rest; Mouse Pad Insert; Translucent edge marring and Comforto System 63 Seating	One (1) Year

\*The Applicable Warranty Periods for these products assume that the product is used an average of not more than forty hours per week. If a product is used more than this, then the Applicable Warranty Period for it will be reduced in proportion to the increased usage. For example, if an auditorium product is used an average of fifty hours per week, then the Applicable Warranty Period for it will be eight years.

This warranty does not apply to “normal wear and tear,” and it does not apply to any product that has been damaged by transportation or other movement of the product or that has been altered without Haworth’s express written authorization or to consumable products, such as bulbs, light ballast and surge suppression products. This warranty does not apply to any European Collection non-standard Specials products or to any “Customer’s Own Material” (i.e., material specified by the buyer that is not a standard Haworth product offering) used in the manufacture of a Haworth product. A natural variation occurring in wood, marble or leather is not considered a defect under the terms of this warranty. Haworth does not warrant the colorfastness or the matching of color, grain or texture of wood, marble, leather or fabric. A product will not be considered defective, and Haworth will not be obligated to repair or replace it, if the product is not installed and used as recommended in Haworth’s written planning, installation and user guides.

EXCEPT AS STATED ABOVE, HAWORTH MAKES NO EXPRESS OR IMPLIED WARRANTY AS TO ANY PRODUCT. HAWORTH MAKES NO WARRANTIES OF MERCHANTABILITY OR OF FITNESS FOR ANY PARTICULAR PURPOSE. Product repair or replacement in accordance with this warranty is the buyer’s exclusive remedy for any and all product defects. Haworth shall not have any tort liability with respect to any product, and Haworth shall not be liable for any consequential, economic, indirect, special, punitive or incidental damages arising from any product defect.

# Index

Products are listed alphabetically in this index by alpha-numeric prefix/suffix codes.

<u>Product Code</u>	<u>Product Description</u>	<u>Page</u>
5330-2901	Task Light Mounting Bracket .....	98
5818-1816	Galerie Collection 5800 Series Tables .....	200
5818-1822	Galerie Collection 5800 Series Tables .....	200
5826-2616	Galerie Collection 5800 Series Tables .....	200
5826-2622	Galerie Collection 5800 Series Tables .....	200
5918-1816	Galerie Collection 5900 Series Tables .....	201
5918-1822	Galerie Collection 5900 Series Tables .....	201
5926-2616	Galerie Collection 5900 Series Tables .....	201
5926-2622	Galerie Collection 5900 Series Tables .....	201
6416-1616	Dendhur Group Tables .....	202
6418-1818	Dendhur Group Tables .....	202
6422-2223	Dendhur Group Tables .....	202
6423-2322	Dendhur Group Tables .....	202
6436-3616	Dendhur Group Tables .....	202
6437-3715	Dendhur Group Tables .....	202
AACD-1820	Center Pencil Drawer .....	151
AAG-1	Grommet .....	152
AAPT-1	Pencil Tray .....	151
AAVD-4848	Presentation Board .....	149
ABBD	Varia Cylinder Table Bases by SMED .....	193
ABBH	Varia Slab Table Bases by SMED .....	190
ABBL	Varia X and L Table Bases by SMED .....	191, 192
ABBX	Varia X and L Table Bases by SMED .....	191, 192
ABCB	Varia Table Tops by SMED — Boat .....	188
ABCE	Varia Table Tops by SMED — Rectangle .....	189
ABCR	Varia Table Tops by SMED — Round .....	188
ABCT	Varia Table Tops by SMED — Racetrack .....	189
ABDE-18-1N	Varia Drum Tables by SMED .....	205
ABDE-24-1N	Varia Drum Tables by SMED .....	205
ABDE-30-1G	Varia Drum Tables by SMED .....	205
ABDF-30-1N	Varia Drum Tables by SMED .....	205
ABLC-3030	Varia Leg Tables by SMED .....	203
ABLF-2044	Varia Leg Tables by SMED .....	203
ABR-2042	Bridge .....	122
ABR-2048	Bridge .....	122
ABR-2442	Bridge .....	122
ABR-2448	Bridge .....	122
ABUC-3030	Varia Cube Tables by SMED .....	204
ABUF-2044	Varia Cube Tables by SMED .....	204
ACFM-2066-1HDH	Credenza with Double Hinged Door and Two Pedestals .....	136
ACFM-2066-1HLH	Credenza with Lateral File and Two Pedestals .....	134
ACFM-2072-1HDH	Credenza with Double Hinged Door and Two Pedestals .....	136
ACFM-2072-1HLH	Credenza with Lateral File and Two Pedestals .....	134
ACFM-2466-1HDH	Credenza with Double Hinged Door and Two Pedestals .....	136
ACFM-2466-1HLH	Credenza with Lateral File and Two Pedestals .....	134
ACFM-2472-1HDH	Credenza with Double Hinged Door and Two Pedestals .....	136
ACFM-2472-1HLH	Credenza with Lateral File and Two Pedestals .....	134
ACFM-2490-1DLD	Credenza with Lateral File and Two Double Hinged Door Units .....	136

<b>Product Code</b>	<b>Product Description</b>	<b>Page</b>
ACFM-2490-1LDL	Credenza with Double Hinged Door and Two Lateral Files	134
ACFN-2060-1D	Credenza with Doors	135
ACFN-2060-1L	Credenza with Lateral File	133
ACFN-2072-1D	Credenza with Doors	135
ACFN-2072-1L	Credenza with Lateral File	133
ACFN-2460-1D	Credenza with Doors	135
ACFN-2460-1L	Credenza with Lateral File	133
ACFN-2472-1D	Credenza with Doors	135
ACFN-2472-1L	Credenza with Lateral File	133
ACFN-2490-1D	Credenza with Doors	135
ACFN-2490-1L	Credenza with Lateral File	133
ACSD-2066-1HHFN	Credenza with Symmetrical Kneespace	127
ACSD-2072-1HHFN	Credenza with Symmetrical Kneespace	127
ACSD-2466-1HHFN	Credenza with Symmetrical Kneespace	127
ACSD-2484-1HHFN	Credenza with Symmetrical Kneespace	127
ACXL-2066-1DLN	Credenza with Asymmetrical Kneespace — Double Hinged Door	131
ACXL-2066-1LLN	Credenza with Asymmetrical Kneespace — Lateral File	129
ACXL-2072-1DLN	Credenza with Asymmetrical Kneespace — Double Hinged Door	131
ACXL-2072-1LLN	Credenza with Asymmetrical Kneespace — Lateral File	129
ACXL-2466-1DLN	Credenza with Asymmetrical Kneespace — Double Hinged Door	131
ACXL-2466-1LLN	Credenza with Asymmetrical Kneespace — Lateral File	129
ACXL-2472-1DLN	Credenza with Asymmetrical Kneespace — Double Hinged Door	131
ACXL-2472-1LLN	Credenza with Asymmetrical Kneespace — Lateral File	129
ACXL-2484-1DLN	Credenza with Asymmetrical Kneespace — Double Hinged Door	131
ACXL-2484-1LLN	Credenza with Asymmetrical Kneespace — Lateral File	129
ACXL-2490-1DLN	Credenza with Asymmetrical Kneespace — Double Hinged Door	131
ACXL-2490-1LLN	Credenza with Asymmetrical Kneespace — Lateral File	129
ACXM-2490-1DHLN	Credenza with Asymmetrical Kneespace — Double Hinged Door/ Pedestal	132
ACXM-2490-1HDRN	Credenza with Asymmetrical Kneespace — Double Hinged Door/ Pedestal	132
ACXM-2490-1HLRN	Credenza with Asymmetrical Kneespace — Lateral File/Pedestal	130
ACXM-2490-1LHLN	Credenza with Asymmetrical Kneespace — Lateral File/Pedestal	130
ACXS-2066-1HLN	Credenza with Asymmetrical Kneespace — Pedestal File	128
ACXS-2072-1HLN	Credenza with Asymmetrical Kneespace — Pedestal File	128
ACXS-2466-1HLN	Credenza with Asymmetrical Kneespace — Pedestal File	128
ACXS-2472-1HLN	Credenza with Asymmetrical Kneespace — Pedestal File	128
ACXS-2484-1HLN	Credenza with Asymmetrical Kneespace — Pedestal File	128
ADBD-3672	Double Pedestal Desk — Overhang Top with Bow Front	116
ADBS-3672	Single Pedestal Desk — Overhang Top with Bow Front	119
ADED-3684	Double Pedestal Desk — Executive Overhang	116
ADHD-3684	Double Pedestal Desk — Executive Overhang with Bow Front	117
ADOD-3666	Double Pedestal Desk — Overhang Top	115
ADOD-3672	Double Pedestal Desk — Overhang Top	115
ADOS-3666	Single Pedestal Desk with Overhang Top	118
ADOS-3672	Single Pedestal Desk with Overhang Top	118
ADRD-3060	Double Pedestal Desk — Flush Top	115
ADRD-3066	Double Pedestal Desk — Flush Top	115
ADRS-3060	Single Pedestal Desk — Flush Top	118
ADRS-3066	Single Pedestal Desk — Flush Top	118
ADT-3672	Table Desk	114



# Index

<u>Product Code</u>	<u>Product Description</u>	<u>Page</u>
AFL-2036	Lectern .....	149
AFS-2036	Serving Cart .....	149
AFT-1516	Telephone Stand .....	150
AFV-5536	Video Cabinet .....	150
AFV-7236	Video Cabinet .....	150
AKPM-17-SL	Adjustable Keyboard Pads .....	103
AKPM-23-SF	Adjustable Keyboard Pad .....	103
APM-2016	Mobile Pedestal .....	138
ARED-3672	D-Top Desk .....	123
AREP-3072	P-Top Desk .....	123
ARND-3066	D-Top Convergent .....	124
ARND-3672	D-Top Convergent .....	124
ARNP-3072	P-Top Convergent .....	124
ARRH-2042-1LN	Return Shell .....	120
ARRH-2048-1LN	Return Shell .....	120
ARRH-2066-1LN	Return Shell .....	120
ARRH-2442-1LN	Return Shell .....	120
ARRH-2448-1LN	Return Shell .....	120
ARRH-2466-1LN	Return Shell .....	120
ARRL-2066	Return with Lateral File .....	122
ARRL-2466	Return with Lateral File .....	122
ARRS-2042-1HLFN	Return with Pedestal .....	121
ARRS-2048-1HLFN	Return with Pedestal .....	121
ARRS-2066-1HLFN	Return with Pedestal .....	121
ARRS-2442-1HLFN	Return with Pedestal .....	121
ARRS-2448-1HLFN	Return with Pedestal .....	121
ARRS-2466-1HLFN	Return with Pedestal .....	121
ASB2-1530	Two-High Bookcase .....	142
ASB2-1536	Two-High Bookcase .....	142
ASB5-1530	Five-High Bookcase .....	142
ASB5-1536	Five-High Bookcase .....	142
ASB5-2030	Five-High Bookcase .....	142
ASB5-2036	Five-High Bookcase .....	142
ASBE-1515	Radiused End Open Bookcase Deck .....	142
ASBF-1530	Upper Storage Bookcase Unit .....	144
ASBF-1536	Upper Storage Bookcase Unit .....	144
ASCD-2030	Double Door Storage Cabinet .....	141
ASCD-2036	Double Door Storage Cabinet .....	141
ASCD-2430	Double Door Storage Cabinet .....	141
ASCD-2436	Double Door Storage Cabinet .....	141
ASCS-2016-1L	Single Door Storage Cabinet .....	140
ASCS-2416-1L	Single Door Storage Cabinet .....	140
ASDB-2030	Hinged Door Cabinet Open Bookcase .....	139
ASDB-2036	Hinged Door Cabinet Open Bookcase .....	139
ASDB-2430	Hinged Door Cabinet Open Bookcase .....	139
ASDB-2436	Hinged Door Cabinet Open Bookcase .....	139
ASDU-2030	Double Hinged Door .....	138
ASDU-2036	Double Hinged Door .....	138
ASDU-2430	Double Hinged Door .....	138

## Index

<u>Product Code</u>	<u>Product Description</u>	<u>Page</u>
ASDU-2436	Double Hinged Door .....	138
ASEC-2020-1L	Single Door Radiused End Cabinet .....	142
ASEC-2424-1L	Single Door Radiused End Cabinet .....	142
ASL2-2030	Two-High Lateral File .....	138
ASL2-2036	Two-High Lateral File .....	138
ASL2-2430	Two-High Lateral File .....	138
ASL2-2436	Two-High Lateral File .....	138
ASL4-2030	Four-High Lateral File .....	138
ASL4-2036	Four-High Lateral File .....	138
ASL4-2430	Four-High Lateral File .....	138
ASL4-2436	Four-High Lateral File .....	138
ASLB-2030	Two-High Lateral File Open Bookcase .....	139
ASLB-2036	Two-High Lateral File Open Bookcase .....	139
ASLB-2430	Two-High Lateral File Open Bookcase .....	139
ASLB-2436	Two-High Lateral File Open Bookcase .....	139
ASLC-2030	Two-High Lateral File Hinged Door Cabinet .....	139
ASLC-2036	Two-High Lateral File Hinged Door Cabinet .....	139
ASLC-2430	Two-High Lateral File Hinged Door Cabinet .....	139
ASLC-2436	Two-High Lateral File Hinged Door Cabinet .....	139
ASOD-1630	Overhead Bookcase - Wall Mount .....	143
ASOD-1636	Overhead Bookcase - Wall Mount .....	143
ASOO-1630	Overhead Bookcase - Wall Mount .....	143
ASOO-1636	Overhead Bookcase - Wall Mount .....	143
ASVD-2436	VDT Table .....	137
ASWC-2030-1R	Double Door Wardrobe/ Storage Cabinet .....	141
ASWC-2036-1R	Double Door Wardrobe/ Storage Cabinet .....	141
ASWC-2430-1R	Double Door Wardrobe/ Storage Cabinet .....	141
ASWC-2436-1R	Double Door Wardrobe/ Storage Cabinet .....	141
ASWD-2030	Double Door Wardrobe .....	141
ASWD-2036	Double Door Wardrobe .....	141
ASWD-2430	Double Door Wardrobe .....	141
ASWD-2436	Double Door Wardrobe .....	141
ASWS-2016-1L	Single Door Wardrobe .....	140
ASWS-2416-1L	Single Door Wardrobe .....	140
ATRL-7272-1HJRN	Reception L-Desk .....	125
ATRL-7272-1JHLN	Reception L-Desk .....	125
ATRU-7296-1JHN	Reception U-Desk .....	126
ATTB-72	Reception L-Desk Tackboard .....	125
ATTB-96	Reception U-Desk Tackboard .....	126
AUC-2024	Corner Unit .....	137
AVFD-1566	66"(1676mm) Vertical Storage Unit .....	144
AVFD-1572	72"(1829mm) Vertical Storage Unit .....	144
AVFD-1584	84"(2134mm) Vertical Storage Unit .....	145
AVFO-1566	66"(1676mm) Vertical Storage Unit .....	144
AVFO-1572	72"(1829mm) Vertical Storage Unit .....	144
AVFO-1584	84"(2134mm) Vertical Storage Unit .....	145
AVSD-1566	66"(1676mm) Combination Vertical Storage Unit .....	146
AVSD-1572	72"(1829mm) Combination Vertical Storage Unit .....	146
AVSD-1584	84"(2134mm) Combination Vertical Storage Unit .....	146

## Index

<u>Product Code</u>	<u>Product Description</u>	<u>Page</u>
AVSD-1590	90"(2286mm) Combination Vertical Storage Unit .....	147
AVSO-1566	66"(1676mm) Combination Vertical Storage Unit .....	146
AVSO-1572	72"(1829mm) Combination Vertical Storage Unit .....	146
AVSO-1584	84"(2134mm) Combination Vertical Storage Unit .....	146
AVSO-1590	90"(2286mm) Combination Vertical Storage Unit .....	147
AVTF	Vertical Storage Unit Tackboard .....	145
AVTS	Combination Vertical Storage Unit Tackboard .....	147
BECM-AD	Power Hatch — Retrofit Kits .....	194
BECM-BD	Power Hatch — Retrofit Kits .....	194
BECM-CD	Power Hatch — Retrofit Kits .....	194
BECM-DD	Power Hatch — Retrofit Kits .....	194
BEVC-1	Vertical Cable Chain .....	195
CACB-1873	Conference Buffet .....	80
CACC-1830	Conference Caddy .....	80
CD-W	Front-to-Back Hanging Bars — Center Drawer .....	108
CEN2-3030	2-Way Top .....	169
CEN2-3060	2-Way Top .....	169
CENC-3333	Corner Top .....	169
CENE-3015	End Top .....	170
CENS-18	Base .....	170
CPRB	Boat-Shaped Top .....	176
CPRC	Rectangle Top .....	176
CPRQ	Square Top .....	174
CPRR	Round Top .....	174
CPRT	Racetrack Top .....	175
CPVC-1	PVC Vertical Wire Manager .....	195
CPVC-1	Wire Channel .....	152
CSKC	Rectangle Top .....	173
CSKR	Round Top .....	172
CSKT	Racetrack Top .....	172
CTRB	Boat-Shaped Top .....	178
CTRC	Rectangle Top .....	178
CTRQ	Square Top .....	177
CTRR	Round Top .....	177
CTRT	Racetrack Top .....	177
DF	Stationary Pedestal — Standard-Width .....	100
DM	Mobile Pedestal — Standard-Width .....	100
DS	Suspended Pedestal — Standard-Width .....	99
DSLFL	Two-High Undersurface Lateral File .....	102
DX	Fixed Pedestal — Standard-Width .....	99
DXL	Fixed Pedestal — Legal-Width .....	101
FCK-13	Front-to-Back Hanging Bars — File Conversion Kit .....	108
FTB-15	Front-to-Back Hanging Bars .....	108
HFMB-0002	Mailbox .....	34
HGBN	Multi-Purpose Storage Bins .....	35
HGDB-0004	Diskette Bin .....	35
HGMB-0002	Mailbox .....	34
HGRT-0001	Reference Tray .....	35
HGTS	Tackstrip .....	35



## Index

<u>Product Code</u>	<u>Product Description</u>	<u>Page</u>
HTLU	Fixed-Intensity Task Lighting .....	98
HTLU-T	Fixed-Intensity Task Lighting .....	98
HWD2-WW	Convergents — Fixed Height .....	95
HWSG-0001-W	Front-to-Back Hanging Bars — Grommet .....	108
L-AKP-3	Adjustable Keyboard Pad .....	41, 78, 151
L-COS	Convenience Outlet Strip .....	78
LFIL-1	Filler Strip .....	61
L-KT	Keyboard Pullout Tray .....	78, 151
L-LPR-2	Wrist Support .....	41, 78, 151
LPFF-127	Pedestal Filler .....	71
LS-14	Shelf .....	77
LS-30	Shelf .....	77
LTB-1872	Tackboard — Wall Mount .....	64
LTSB-1821	Drum Table .....	199
LTSB-2421	Drum Table .....	199
LTTR-2230	Rectangular Table .....	197
LTTR-2424	End Table .....	197
LTTR-2453	Rectangular Coffee Table .....	198
LTTR-3030	Corner Table .....	198
LTTR-4242	Coffee Table .....	199
L-WMT	Wire Channel .....	42, 79, 152, 195
MSD-6	Front-to-Back Hanging Bars — Stationery Divider .....	108
M-WC24-H	Wire Channel .....	166
M-WC24-V	Wire Channel .....	166
OAHG	Grid .....	34
OATB	Tackboard .....	34
OBCD-4230-C	“Bumper” Docking Table .....	40
OBCD-4230-G	“Bumper” Docking Table .....	40
OBCD-4836-C	“Bumper” Docking Table .....	40
OBCD-4836-G	“Bumper” Docking Table .....	40
OBCR-42-C	Round Table .....	40
OBCR-42-G	Round Table .....	40
OBCR-48-C	Round Table .....	40
OBCR-48-G	Round Table .....	40
OBCT-2736	“Tugger” Mobile Computer Table .....	39
OBLC-2430	“Scooch” Mobile Laptop Caddy .....	39
OBR-2236-F	Bridge .....	29
OBR-2236-N	Bridge .....	29
OBR-2248-F	Bridge .....	29
OBR-2248-N	Bridge .....	29
OCFM-2272-K	Door/Drawer Credenza .....	31
OCSD-2266-JJF	Credenza with Symmetrical Kneespace .....	31
OCSD-2272-JJF	Credenza with Symmetrical Kneespace .....	31
OCXL-2272-LR	Credenza with Lateral Storage .....	30
OCXL-2272-MR	Credenza with Lateral Storage .....	30
OCXL-2272-NR	Credenza with Lateral Storage .....	30
OCXS-2266-JR	Credenza with Asymmetrical Kneespace .....	30
OCXS-2272-JR	Credenza with Asymmetrical Kneespace .....	30
ODOD-3672-JH	Double Pedestal Desk, Overhang Top .....	27

## Index

<b>Product Code</b>	<b>Product Description</b>	<b>Page</b>
ODOD-3672-KK	Double Pedestal Desk, Overhang Top .....	27
ODOS-3672-HR	Single Pedestal Desk, Overhang Top .....	26
ODOS-3672-KR	Single Pedestal Desk, Overhang Top .....	26
ODRD-3060-JH	Double Pedestal Desk, Flush Top .....	27
ODRD-3060-KK	Double Pedestal Desk, Flush Top .....	27
ODRD-3066-JH	Double Pedestal Desk, Flush Top .....	27
ODRD-3066-KK	Double Pedestal Desk, Flush Top .....	27
ODRS-3066-HR	Single Pedestal Desk, Flush Top .....	26
ODRS-3066-KR	Single Pedestal Desk, Flush Top .....	26
OLTD-2	Power Domes .....	42, 78, 152, 166
OLTD-4	Power Domes .....	42, 78, 152, 166
OPMQ-2216	“Putter” Mobile Pedestal .....	39
ORED-3672	D-Top Desk .....	26
ORRL-2272-LLF	Desk-Height Return with Lateral Storage .....	28
ORRL-2272-MLF	Desk-Height Return with Lateral Storage .....	28
ORRL-2272-NLF	Desk-Height Return with Lateral Storage .....	28
ORRS-2248-JLF	Desk-Height Return with Pedestal Storage .....	28
ORRS-2248-KLF	Desk-Height Return with Pedestal Storage .....	28
OSBC-3936	Three-High Bookcase .....	37
OSBC-6836	Five-High Bookcase .....	37
OSBF-3936	Lateral File Mounted Bookcase .....	36
OSLF-2936	Two-High Lateral File .....	36
OSOL	Adjustable Shelf .....	34
OSWC-6824-NL	Wardrobe/Storage Cabinet .....	38
OSWC-6824-NR	Wardrobe/Storage Cabinet .....	38
OSWF-6824-NL	Wardrobe/File Storage Cabinet .....	38
OSWF-6824-NR	Wardrobe/File Storage Cabinet .....	38
OTBC-3038	Two-High Bookcase .....	164
OTBC-5238	Four-High Bookcase .....	164
OTBE-2433	Desk-Height Bridge .....	159
OTBE-2442	Desk-Height Bridge .....	159
OTBE-2450	Desk-Height Bridge .....	159
OTC-2066-969	Door/Drawer Credenzas .....	163
OTC-2072-969	Door/Drawer Credenzas .....	163
OTCB-4766	Open Vertical Storage Unit .....	165
OTCB-4772	Open Vertical Storage Unit .....	165
OTCK-2066-9M9	Kneespace Credenzas .....	163
OTCK-2072-9M9	Kneespace Credenzas .....	163
OTCS-2437	VDT Table .....	166
OTCU-4141	Corner Unit .....	160
OTDD-3060	Double Pedestal Desk Flush Top .....	156
OTDD-3666	Double Pedestal Desk Flush Top .....	156
OTDO-3672	Double Pedestal Desk Overhang Top .....	156
OTDO-4482	Double Pedestal Desk Overhang Top .....	156
OTDS-3066-L	Single Pedestal Desk .....	157
OTDS-3672-L	Single Pedestal Desk .....	157
OTDT-3666	Table Desk .....	155
OT-KT	Keyboard Pull-out Tray .....	166
OTLE-3672-L	Executive L-Desk .....	161

## Index

<u>Product Code</u>	<u>Product Description</u>	<u>Page</u>
OTLF-238	Two-High Lateral Files .....	164
OTLF-266	Two-High Lateral Files .....	164
OTLF-438	Four-High Lateral File .....	164
OTPB-4848	Presentation Board .....	165
OTRE-2449-R	Desk-Height Return .....	158
OTSU-2072-R	Double Pedestal Credenza .....	160
OTSU-2072-SL	Single Pedestal Credenza .....	160
OTTB-66D	Tackboard .....	165
OTTB-72D	Tackboard .....	165
OTTC-3672	Rectangle Table .....	196
OTTC-4290	Rectangle Table .....	196
OTTC-4482	Rectangle Table .....	196
OTTC-4820	Rectangle Table .....	196
OTTC-4850	Rectangle Table .....	196
OTTO-1946	Coffee Table .....	206
OTTO-2424	End Table .....	206
OTTR-42	Round Table .....	196
OTTR-48	Round Table .....	196
OTTS-2066	Console Table .....	155
OTUE-3672-R	Executive U-Station Double Pedestal Credenza .....	162
OTUE-3672-SR	Executive U-Station Single Pedestal Credenza .....	162
OTVS-4766	Four-Door Vertical Storage Unit .....	165
OTVS-4772	Four-Door Vertical Storage Unit .....	165
OTW-7638	Wardrobe Unit .....	164
OUC-2236-F	Corner Unit without Modesty Panels .....	29
OUC-2236-N	Corner Unit without Modesty Panels .....	29
OVF-3966-K	Four Door Vertical Storage Unit .....	32
OVF-3972-K	Four Door Vertical Storage Unit .....	32
OVS-3972-K	Vertical Storage Unit Open Center Storage .....	33
OVX-3972-KL	Two Door Vertical Storage Unit .....	33
OWM-6612	Wire Management Arc .....	42
OWM-7212	Wire Management Arc .....	42
PDS	Suspended Pedestal with Base — Standard-Width .....	99
PS-C	Front-to-Back Hanging Bars — Wood Pedestal Spacer .....	108
PS-F	Front-to-Back Hanging Bars — Wood Pedestal Spacer .....	108
PTW-1	Front-to-Back Hanging Bars — Pencil Tray .....	108
SBS	30"(762mm) Wide Slab Base .....	183
SBW	24"(610mm)/ 30"(762mm) Wide X Base .....	182
SBX	24"(610mm)/ 30"(762mm) Wide X Base .....	182
SBY3	12"(305mm)/ 16"(406mm) Diameter Cluster Base .....	181
SBY4	12"(305mm)/ 16"(406mm) Diameter Cluster Base .....	181
SBYB	18"(457mm)/ 24"(610mm) Diameter Cylinder Bases .....	179
SBYI	18"(457mm)/ 24"(610mm) Diameter Half-Cylinder Bases .....	180
TBDL-3672-1N	Desk with Bow Front Shell .....	55
TCD-2166-1NK	Four Door Credenza .....	53
TCD-2172-1NK	Four Door Credenza .....	53
TCF-2166-1SNK	Door/Drawer Credenza with Full-Height Pedestals .....	52
TCF-2172-1SNK	Door/Drawer Credenza with Full-Height Pedestals .....	52
TCFD-2166-1SN	Double File Credenza .....	53

# Index

<b>Product Code</b>	<b>Product Description</b>	<b>Page</b>
TCFD-2172-1SN	Double File Credenza .....	53
TCKF-2166-1SN	Kneespace Credenza with Full-Height Pedestals .....	52
TCKF-2172-1SN	Kneespace Credenza with Full-Height Pedestals .....	52
TDDB-1SN	Double Pedestal Desk with Bow Front Full-Height Pedestals .....	49
TDSB-1SN	Single Pedestal Desk with Bow Front Full-Height Pedestal .....	48
TDSF-1SN	Single Pedestal Desk with Full-Height Pedestal .....	48
TLDR-8272-1SNR	Reception L-Desk .....	65
TLDR-8284-1SNR	Reception L-Desk .....	65
TLEF-3066-1SNR	L-Desk with Full-Height Pedestals .....	50
TLEF-3672-1SNR	L-Desk with Full-Height Pedestals .....	50
TPF2-S	File/File Pedestal .....	70
TPF2-W	File/File Pedestal .....	70
TPF3-S	Box/Box/File Pedestal .....	70
TPF3-W	Box/Box/File Pedestal .....	70
TPF5-S	Lateral File .....	71
TPF5-W	Lateral File .....	71
TPF6-K	Storage Compartment .....	71
TPM1-20-S	Mobile Pedestal .....	71
TPM1-20-W	Mobile Pedestal .....	71
TPM3-20-S	Mobile Pedestal .....	71
TPM3-20-W	Mobile Pedestal .....	71
TRBC-2936-1FN	Two-High Bookcase .....	74
TRBC-2936-1SN	Two-High Bookcase .....	74
TRBC-4836-1FN	Four-High Bookcase .....	74
TRBC-4836-1SN	Four-High Bookcase .....	74
TRBC-6436-1FN	Five-High Bookcase .....	75
TRBC-6436-1SN	Five-High Bookcase .....	75
TRBE-1NF	Bridge .....	61
TRCS-2429-1NG	CRT Table .....	68
TRCU-2442-1F	Corner Unit .....	67
TRCU-2442-1Q	Corner Unit .....	67
TRCU-3042-1F	Corner Unit .....	67
TRCU-3042-1Q	Corner Unit .....	67
TRDD-1SN	Double Pedestal Desk with Full-Height Pedestals .....	49
TRDL-1N	Desk and Credenza Shells .....	54
TRDT-3672-1	Table Desk .....	47
TRED-3072-1N	D-Top Desk Extension with End Panel .....	56
TREP-3072-1NR	P-Top Desk Extension with End Panel .....	58
TRLF-237-1	Two-High Lateral File .....	72
TRLF-331	Three-High Lateral File .....	72
TRLF-431	Four-High Lateral File .....	72
TRLS-231	Two-High Lateral File with Storage Compartment .....	73
TRLS-331	Three-High Lateral File with Storage Compartment .....	73
TRMC-2432-1NG	Cabinet .....	69
TRMD-3072-1NFR	D-Top Desk with Modesty Panel .....	57
TRMP-3072-1NFR	P-Top Desk with Modesty Panel .....	59
TRND-3072-1N	D-Top Desk Extension .....	56
TRNP-3072-1NR	P-Top Desk Extension .....	58
TROC-7264-K	Overhead Cabinet .....	63

## Index

<b>Product Code</b>	<b>Product Description</b>	<b>Page</b>
TROC-7276-K	Overhead Cabinet with Shelves .....	64
TRPU-2429-1NG	Printer Unit .....	68
TRRE-1NFL	Return .....	60
TRS-6418-NR	64"(1626mm) Individual Storage Cabinet .....	77
TRS-6432-N	64"(1626mm) Storage Cabinet .....	76
TRTB	Metal X Base .....	184
TRVC-7236-N	Video Cabinet .....	77
TRVS-3542	Corner Vertical Storage Unit .....	67
TRVS-3572-K	Vertical Storage Unit .....	62
TRW-6418-NR	64"(1626mm) Individual Wardrobe Cabinet .....	77
TRW-6432-N	64"(1626mm) Wardrobe Cabinet .....	76
TRWS-6432-N	64"(1626mm) Wardrobe/Storage Cabinet .....	76
TTBC-1942	Corner Vertical Storage Unit Tackboard .....	68
TTBV-1972	Vertical Storage Unit – Tackboards .....	62
TUDR-3672-1SNL	Reception U-Desk .....	66
TUEF-3066-1SN	U-Station with Full-Height Pedestals .....	51
TUEF-3672-1SN	U-Station with Full-Height Pedestals .....	51
TXLF-3672-1SNR	L-Desk with Full-Height Pedestals .....	50
WBE2	Desk-Height Bridge — Full-Height Modesty Panel .....	91
WBF1	Adjustable Keyboard Pad — Five-High Bookcase .....	103
WBF1	Adjustable Keyboard Pad — Four-High Bookcase .....	103
WBF1	Adjustable Keyboard Pad — Three-High Bookcase .....	103
WBF2	Adjustable Keyboard Pad — Two-High Bookcase .....	103
WBF2-D	Adjustable Keyboard Pad — Two-High Bookcase with Doors .....	103
WBFS	Bookcase Shelf .....	105
WCC2	90° Corners — Full-Height Modesty Panels .....	95
WCF2	Credenza Case — Full-Height Back Panel .....	92
WCF2-HTH	Credenza — Full-Height Back Panel — Standard Pedestals .....	93
WCF2-JFJ	Credenza — Full-Height Back Panel — Standard Pedestals — Lateral Files .....	94
WCF2-JJ	Credenza — Full-Height Back Panel — Standard Pedestals .....	93
WCF2-L	Credenza Case — Full-Height Back Panel — Right- or Left-Hand Access .....	92
WCF2-R	Credenza Case — Full-Height Back Panel — Right- or Left-Hand Access .....	92
WDD2-W	Convergents — D-Shaped — with Modesty Panel .....	95
WDF2	Desk Shell — Full-Height Modesty Panel .....	86
WDF2-H	Single Pedestal Desk — Full-Height Modesty Panel .....	87
WDF2-HH	Double Pedestal Desk — Full-Height Modesty Panel .....	88
WDF2-HJ	Double Pedestal Desk — Full-Height Modesty Panel .....	88
WDF2-J	Single Pedestal Desk — Full-Height Modesty Panel .....	87
WDT2	Table Desks .....	85
WLF1	Bookcase Shelf — Four-High Lateral File .....	105
WLF1	Bookcase Shelf — Two-High Lateral File .....	105
WLF2	Bookcase Shelf — Two-High Lateral File .....	105
WRE2	Desk-Height Return Case — Full-Height Modesty Panel .....	89
WRE2-H	Desk-Height Return — Full-Height Modesty Panel .....	90
WRE2-J	Desk-Height Return — Full-Height Modesty Panel .....	90
WSG-1	Grommet .....	19
WVFT	Vertical Storage Unit — Flipper Door Unit with Tackboards .....	97
WVHT	Vertical Storage Unit — Hinged Door Unit with Tackboards .....	96
WVT-1	Vertical Storage Unit Template — Wood Units .....	98

# Index

<u>Product Code</u>	<u>Product Description</u>	<u>Page</u>
WWC	Bookcase Shelf — Wardrobe Unit .....	105
WWD	Bookcase Shelf — Storage/File Unit .....	105
WWP	Bookcase Shelf — Wardrobe/Storage Unit .....	105
WWPS	Bookcase Shelf — Wardrobe/Storage Unit Shelf .....	105
WWS	Bookcase Shelf — Storage Unit .....	105
WWSS	Bookcase Shelf — Wardrobe/Storage Unit Shelf .....	105
Y-AKT	Articulating Keyboard Tray .....	166
YALF-15	Lateral File Accessories .....	42, 79, 152
YAPP-16	16 1/2' Pedestal Drawer Accessories .....	79
YAVD-4848-W	Presentation Board .....	81
Y-G	Wireway Grommet and Caps (Field Installed) .....	166
YHTL-0024-T	Fixed-Intensity Task Lighting (Steel Bottom Vertical Storage Unit) .....	63
YHTL-0024-WT	Fixed-Intensity Task Lighting (Wood Bottom Vertical Storage Unit) .....	33, 67, 148
YHTL-0024-WTC	Fixed-Intensity Task Lighting (Wood Bottom Vertical Storage Unit) .....	33, 67, 148
YRCD-1	Center Drawer .....	41, 78
YSG-1	Grommet .....	41, 79
YTL-60	Task Light .....	165
YTL-70	Task Light .....	165
ZAT-3030	Adjustable Mobile Table .....	20
ZBC-3650	Four-High Bookcase .....	17
ZBC-3664	Five-High Bookcase .....	18
ZBR-2448	Bridge .....	11
ZCD-2466	Credenza with Double Pedestal .....	13
ZCD-2472	Credenza with Double Pedestal .....	13
ZCL-2466	Credenza with Single Pedestal .....	12
ZCL-2472	Credenza with Single Pedestal .....	12
ZCR-2466	Credenza with Single Pedestal .....	12
ZCR-2472	Credenza with Single Pedestal .....	12
ZDB-1	Diskette/CD Bin .....	19
ZDC-3066	D-Top Convergents .....	15
ZDC-3672	D-Top Convergents .....	15
ZDD-3066	Double Pedestal Desk .....	10
ZDD-3672	Double Pedestal Desk .....	10
ZDE-3066	D-Top Desks .....	15
ZDE-3672	D-Top Desks .....	15
ZDL-3066	Single Pedestal Desk .....	9
ZDL-3672	Single Pedestal Desk .....	9
ZDR-3066	Single Pedestal Desk .....	9
ZDR-3672	Single Pedestal Desk .....	9
ZEL-2472	Extended Corner Shell .....	14
ZER-2472	Extended Corner Shell .....	14
ZKS-1	Corner Keyboard Support .....	18
ZKT-1	Sliding Keyboard Tray .....	18
ZLF-2436	Lateral File .....	17
ZMP-1827	Mobile Pedestal .....	17
ZPD-1	Pencil Drawer .....	18
ZPM-1	Pop-up Power and Data Module .....	19
ZRL-2448	Executive Return .....	11
ZRR-2448	Executive Return .....	11

# Index

---

<u>Product Code</u>	<u>Product Description</u>	<u>Page</u>
ZRT-42	Round Conference Table .....	20
ZSL-3664	Storage/Lateral File Unit .....	17
ZTB-66	Tackboard .....	18
ZTB-72	Tackboard .....	18
ZTC-3672	Rectangular Conference Table .....	20
ZTC-4896	Rectangular Conference Table .....	20
ZTL-48	Task Light .....	16
ZVS-3566	Vertical Storage Unit .....	16
ZVS-3572	Vertical Storage Unit .....	16
ZVS-3966	Vertical Storage Unit .....	16
ZVS-3972	Vertical Storage Unit .....	16
ZWM-72	Self-Adhesive Wiring Channel .....	19

[www.haworth.com](http://www.haworth.com)

**HAWORTH®**

Furniture For What's Next®

Haworth, Inc. One Haworth Center Holland, MI 49423-9576 USA

For information regarding Haworth products and services,  
call 800.344.2600 (US and Canada) or 616.393.3000

Haworth is a registered trademark of Haworth, Inc.

Printed in USA / ©Haworth, Inc. 2002 / 6.02 / Item # 2128